

# AVIATION SPECIFICATIONS 5

## AERODROMES

EFFECTIVE DATE : 1 MARCH 2023  
REVISION NO : 0

### TABLE OF CONTENTS

1	Introduction .....	4
2	Definitions .....	4
3	Common Reference Systems .....	4
4	Aerodrome Reference Code .....	5
5	Aerodrome related data .....	6
5.1	Aeronautical data .....	6
5.2	Aerodrome reference point.....	6
5.3	Aerodrome and runway elevation.....	6
5.4	Aerodrome reference temperature .....	7
5.5	Aerodrome dimensions and related information .....	7
5.6	Strength of pavements .....	8
5.7	Pre-flight altimeter check location.....	11
5.8	Declared distances .....	11
5.9	Condition of the movement area and related facilities .....	12
5.10	Runway surface condition for use in the runway condition report .....	14
5.11	Disabled aircraft removal .....	14
5.12	Rescue and fire-fighting .....	14
5.13	Visual approach slope indicator systems.....	15
6	Physical Characteristics .....	16
6.1	Runways .....	16
6.2	Runway shoulders .....	19
6.3	Runway turn pads .....	20
6.4	Runway strips .....	20
6.5	Runway end safety areas.....	23
6.6	Clearways .....	24
6.7	Stopways .....	25
6.8	Radio altimeter operating area .....	26
6.9	Taxiways.....	26

---

6.10	Taxiway shoulders .....	30
6.11	Taxiway strips .....	30
6.12	Holding bays, runway-holding positions, intermediate holding positions and road-holding positions .....	31
6.13	Aprons .....	33
6.14	Isolated aircraft parking position .....	33
7	Obstacle Restriction and Removal .....	34
7.1	Obstacle limitation surfaces .....	34
7.2	Obstacle limitation requirements .....	40
8	Visual Aids for Navigation .....	46
8.1	Indicators and signalling devices .....	46
8.2	Markings .....	47
8.3	Lights .....	64
8.4	Signs .....	105
8.5	Markers .....	115
9	Visual Aids for Denoting Obstacles .....	117
9.1	Objects to be marked and/or lighted .....	117
9.2	Marking and/or lighting of objects .....	118
10	Visual Aids for Denoting Restricted Use Areas .....	126
10.1	Closed runways and taxiways, or parts thereof .....	126
10.2	Non-load-bearing surfaces .....	127
10.3	Pre-threshold area .....	128
10.4	Unserviceable areas .....	128
11	Electrical Systems .....	130
11.1	Electrical power supply systems for air navigation facilities .....	130
11.2	System design .....	133
11.3	Monitoring .....	133
12	Aerodrome Operational Services, Equipment and Installations .....	134
12.1	Rescue and firefighting .....	134
12.2	Other special services .....	139
12.3	Apron management service .....	139
12.4	Surface movement guidance and control systems .....	140
12.5	Siting of equipment and installations on operational areas .....	140
12.6	Fencing .....	141
12.7	Security lighting .....	142
12.8	Autonomous runway incursion warning system .....	142
13	Aerodrome Maintenance .....	143
13.1	Pavements .....	143

13.2	Removal of contaminants.....	144
13.3	Runway pavement overlays .....	144
13.4	Visual aids .....	145
Appendix 1	Definitions .....	148
Appendix 2	Colours for aeronautical ground lights, markings, signs and panels ....	158
Appendix 3	Aeronautical ground light characteristics .....	164
Appendix 4	Mandatory instruction markings and information markings .....	191
Appendix 5	Requirements concerning design of taxiing guidance signs .....	196
Appendix 6	Location of lights on obstacles .....	207

## 1 Introduction

- 1.1 Aviation Specifications 5 – Aerodromes (“AS-5”) is issued by the Director-General of Civil Aviation pursuant to the Air Navigation (139 – Aerodromes) Regulations 2023 (“ANR-139”), and specify the design, operations and maintenance requirements of an aerodrome certified under the ANR-139.
- 1.2 AS-5 applies to a certified operator to whom an aerodrome certificate is granted or renewed under regulation 6 of the ANR-139, or transferred in accordance with regulation 9, and that remains in force, and any reference to a certified operator is a reference to the holder of that aerodrome certificate.

## 2 Definitions

- 2.1 Any term in these Specifications that is defined in the First Schedule to the ANR-139 has the meaning given to that term in that Schedule unless the term is otherwise defined in Appendix 1 to this AS-5.

## 3 Common Reference Systems

- 3.1 A certified aerodrome operator must use the following reference systems:

- (a) Horizontal reference system

The World Geodetic System – 1984 (WGS-84) must be used as the horizontal (geodetic) reference system. Reported aeronautical geographical coordinates (indicating latitude and longitude) must be expressed in terms of the WGS-84<sup>1</sup> geodetic reference datum.

- (b) Vertical reference system

The Mean sea level (MSL) datum, which gives the relationship of gravity-related height (elevation)<sup>2</sup> to a surface known as the geoid, must be used as the vertical reference system.

- (c) Temporal reference system

The Gregorian calendar and Coordinated Universal Time (UTC) must be used as the temporal reference system.

---

<sup>1</sup> Comprehensive guidance material concerning WGS-84 is contained in the World Geodetic System – 1984 (WGS-84) Manual (Doc 9674).

<sup>2</sup> Gravity-related heights (elevations) are also referred to as orthometric heights while distances of points above the ellipsoid are referred to as ellipsoidal heights.

## 4 Aerodrome Reference Code

- 4.1 An aerodrome reference code<sup>3</sup> comprising of a code number and letter, which is selected for aerodrome planning purposes, must be determined in accordance with the characteristics of the aeroplane for which an aerodrome facility is intended.
- 4.2 The aerodrome reference code numbers and letters must have the meanings assigned to them in Table 4-1.
- 4.3 The code number for element 1 must be determined from Table 4-1 by selecting the code number corresponding to the highest value of the aeroplane reference field<sup>4</sup> lengths of the aeroplanes for which the runway is intended.
- 4.4 The code letter for element 2 must be determined from Table 4-1, by selecting the code number which corresponds to the greatest wingspan<sup>5</sup> of the aeroplanes for which the facility is intended.

Table 4-1 – Aerodrome Reference Code

<b>Code number for element 1</b>	
<i>Code number</i>	<i>Aeroplane reference field length</i>
1	Less than 800 m
2	800 m up to but not including 1 200 m
3	1 200 m up to but not including 1 800 m
4	1 800 m and over
<b>Code letter for element 2</b>	
<i>Code letter</i>	<i>Wingspan</i>
A	Up to but not including 15m
B	15m up to but not including 24m
C	24m up to but not including 36m
D	36m up to but not including 52m
E	52m up to but not including 65m
F	65m up to but not including 80m

<sup>3</sup> Guidance on determining the aerodrome reference code is given in the ICAO Aerodrome Design Manual (Doc 9157), Parts 1 and 2.

<sup>4</sup> The determination of the aeroplane reference field length is solely for the selection of a code number and is not intended to influence the actual runway length provided. Guidance on determining the runway length is given in the ICAO Aerodrome Design Manual, (Doc 9157), Part 1 — Runways.

<sup>5</sup> Guidance on planning for aeroplanes with wingspans greater than 80 m is given in the ICAO Aerodrome Design Manual (Doc 9157) Parts 1 and 2. Procedures on conducting aerodrome compatibility study to accommodate aeroplanes with folding wing tips spanning two code letters are given in the Procedures for Air Navigation Services Aerodromes (PANS-Aerodromes, Doc 9981). Further guidance can be found in the manufacturer's aircraft characteristics for airport planning manual.

## **5 Aerodrome related data**

### **5.1 Aeronautical data**

- 5.1.1 Determination and reporting of aerodrome related aeronautical data to the aeronautical information service (“AIS”) provider must be in accordance with the accuracy and integrity classification<sup>6</sup> required to meet the needs of the end-users of aeronautical data.
- 5.1.2 Where aerodrome mapping data is made available to the AIS provider, the selection<sup>7</sup> of the aerodrome mapping data features to be collected must be made with consideration of the intended applications.
- 5.1.3 Digital data error detection techniques<sup>8</sup> must be used during the transmission and/or storage of aeronautical data and digital data sets.

### **5.2 Aerodrome reference point**

- 5.2.1 A certified aerodrome operator must establish an aerodrome reference point must be established for an aerodrome.
- 5.2.2 The aerodrome reference point must be located near the initial or planned geometric centre of the aerodrome and must normally remain where first established.
- 5.2.3 The position of the aerodrome reference point must be measured and reported to the AIS provider in degrees, minutes and seconds.

### **5.3 Aerodrome and runway elevation**

- 5.3.1 The aerodrome elevation and geoid undulation<sup>9</sup> at the aerodrome elevation position must be measured to the accuracy of one-half metre and reported to the AIS provider.
- 5.3.2 For an aerodrome used by international civil aviation for non-precision approaches, the elevation and geoid undulation of each threshold, the elevation of the runway end and any significant high and low intermediate points along the runway must be measured to the accuracy of one-half metre and reported to the AIS provider.
- 5.3.3 For precision approach runway, the elevation and geoid undulation of the threshold, the elevation of the runway end and the highest elevation of the touchdown zone must be measured to the accuracy of one-quarter metre and reported to the AIS provider.

---

<sup>6</sup> Specifications concerning the accuracy and integrity classification related to aerodrome-related aeronautical data are contained in ICAO PANS-AIM (Doc 10066), Appendix 1.

<sup>7</sup> It is intended that the selection of the features to be collected match a defined operational need. Aerodrome mapping databases can be provided at one of two levels of quality — fine or medium. These levels and the corresponding numerical requirements are defined in RTCA Document DO-272B and European Organization for Civil Aviation Equipment (EUROCAE) Document ED-99C — User Requirements for Aerodrome Mapping Information.

<sup>8</sup> Detailed specifications concerning digital data error detection techniques are contained in ICAO PANS-AIM (Doc 10066).

<sup>9</sup> Geoid undulation must be measured in accordance with the appropriate system of coordinates.

#### **5.4 Aerodrome reference temperature**

- 5.4.1 An aerodrome reference temperature must be determined for an aerodrome in degrees Celsius.

#### **5.5 Aerodrome dimensions and related information**

- 5.5.1 The following data must be measured or described, as appropriate, for each facility provided on an aerodrome:
- (a) runway – true bearing to one-hundredth of a degree, designation number, length, width, displaced threshold location to the nearest metre, slope, surface type, type of runway and, for a precision approach runway category I, the existence of an obstacle free zone when provided;
  - (b) strip, runway end safety area, stopway – length, width to the nearest metre, surface type;
  - (c) arresting system – location (which runway end) and description;
  - (d) taxiway – designation, width, surface type;
  - (e) apron – surface type, aircraft stands;
  - (f) the boundaries of the air traffic control service;
  - (g) clearway – length to the nearest metre, ground profile;
  - (h) visual aids for approach procedures, marking and lighting of runways, taxiways and aprons, other visual guidance and control aids on taxiways and aprons, including runway-holding positions and stopbars, and location and type of visual docking guidance systems;
  - (i) location and radio frequency of any VOR aerodrome check-point;
  - (j) location and designation of standard taxi-routes; and
  - (k) distances to the nearest metre of localizer and glide path elements comprising an instrument landing system (ILS) or azimuth and elevation antenna of microwave landing system (MLS) in relation to the associated runway extremities.
- 5.5.2 The geographical coordinates of each threshold must be measured and reported to the AIS provider in degrees, minutes, seconds and hundredths of seconds.
- 5.5.3 The geographical coordinates of appropriate taxiway centre line points must be measured and reported to the AIS provider in degrees, minutes, seconds and hundredths of seconds.
- 5.5.4 The geographical coordinates of each aircraft stand must be measured and reported to the AIS provider in degrees, minutes, seconds and hundredths of seconds.

5.5.5 The geographical coordinates of obstacles in Area 2 (the part within the aerodrome boundary) and in Area 3<sup>10</sup> must be measured and reported to the AIS provider in degrees, minutes, seconds and tenths of seconds. In addition, the top elevation, type, marking and lighting (if any) of obstacles must be reported to the AIS provider.

## **5.6 Strength of pavements**

5.6.1 The certified operator must determine the bearing strength of a pavement.

5.6.2 The bearing strength of a pavement intended for aircraft of apron (ramp) mass greater than 5 700 kg must be made available to the AIS provider using the aircraft classification number – pavement classification number (ACN-PCN) method by reporting all of the following information

- (a) the pavement classification number (PCN<sup>11</sup>);
- (b) pavement type of ACN-PCN determination;
- (c) subgrade strength category;
- (d) maximum allowable tire pressure category or maximum allowable tire pressure value; and
- (e) evaluation method.

5.6.3 The pavement classification number<sup>12</sup> (PCN) reported to the AIS provider must indicate that an aircraft with an aircraft classification number (ACN) equal to or less than the reported PCN can operate on the pavement subject to any limitation on the tire pressure, or aircraft all-up mass for the specified aircraft type(s).

5.6.4 The ACN<sup>13</sup> of an aircraft must be determined in accordance with the standard procedures associated with the ACN-PCN method.

5.6.5 For the purposes of determining the ACN, the behaviour of a pavement must be classified as equivalent to a rigid or flexible construction.

---

<sup>10</sup>PANS-AIM (Doc 10066), Appendix 8 provides requirements for obstacle data determination in Areas 2 and 3.

<sup>11</sup> If necessary, PCNs may be published to an accuracy of one-tenth of a whole number.

<sup>12</sup> Different PCNs may be reported if the strength of the pavement is subject to significant seasonal variation.

<sup>13</sup> The standard procedures for determining the ACN of an aircraft are given in the ICAO Aerodrome Design Manual, Part 3. For convenience several aircraft types currently in use have been evaluated on rigid and flexible pavements founded on the four subgrade categories in paragraph 5.6.6 b) and the results tabulated in that manual.



5.6.6 Information on pavement type for ACN-PCN determination, subgrade strength category, maximum allowable tire pressure category and evaluation method must be reported to the AIS provider using the following codes:

- (a) Pavement type for ACN-PCN determination:
- |                   | <u>Code</u> |
|-------------------|-------------|
| Rigid pavement    | R           |
| Flexible pavement | F           |
- If the actual construction is composite or non-standard, include a note to that effect (See Example 2 below).*
- (b) Subgrade strength category:
- |   | <u>Code</u> |
|---|-------------|
| High strength: characterized by $K = 150 \text{ MN/m}^3$ and representing all $K$ values above $120 \text{ MN/m}^3$ for rigid pavements, and by $\text{CBR} = 15$ and representing all $\text{CBR}$ values above 13 for flexible pavements.       | A           |
| Medium strength: characterized by $K = 80 \text{ MN/m}^3$ and representing a range in $K$ of 60 to $120 \text{ MN/m}^3$ for rigid pavements, and by $\text{CBR} = 10$ and representing a range in $\text{CBR}$ of 8 to 13 for flexible pavements. | B           |
| Low strength: characterized by $K = 40 \text{ MN/m}^3$ and representing a range in $K$ of 25 to $60 \text{ MN/m}^3$ for rigid pavements, and by $\text{CBR} = 6$ and representing a range in $\text{CBR}$ of 4 to 8 for flexible pavements.       | C           |
| Ultra low strength: characterized by $K = 20 \text{ MN/m}^3$ and representing all $K$ values below $25 \text{ MN/m}^3$ for rigid pavements, and by $\text{CBR} = 3$ and representing all $\text{CBR}$ values below 4 for flexible pavements.      | D           |
- (c) Maximum allowable tire pressure category<sup>14</sup>:
- |                                      | <u>Code</u> |
|--------------------------------------|-------------|
| Unlimited : no pressure limit        | W           |
| High: pressure limited to 1.75 MPa   | X           |
| Medium: pressure limited to 1.25 MPa | Y           |
| Low: pressure limited to 0.50 MPa    | Z           |
- (d) Evaluation method:
- |   | <u>Code</u> |
|---|-------------|
| Technical evaluation: representing a specific study of the pavement characteristics and application of pavement behaviour technology. | T           |

---

<sup>14</sup> See footnote to paragraph 13.1.1 where the pavement is used by aircraft with tire pressures in the upper categories

Using aircraft experience: representing a knowledge of the specific type and mass of aircraft satisfactorily being supported under regular use.

U

5.6.7 The following examples illustrate how pavement strength data are reported under the ACN-PCN method.

*Example 1* – If the bearing strength of a rigid pavement, resting on a medium strength subgrade, has been assessed by technical evaluation to be PCN 80 and there is no tire pressure limitation, then the reported information would be:

PCN 80/ R / B / W / T
-----------------------

*Example 2* – If the bearing strength of a composite pavement, behaving like a flexible pavement and resting on a high strength subgrade, has been assessed using aircraft experience to be PCN 50 and the maximum tire pressure allowable is 1.25 MPa, then the reported information would be:

PCN 50/ F / A / Y / U
-----------------------

*Note - Composite construction.*

*Example 3* – If the bearing strength of a flexible pavement, resting on a medium strength subgrade, has been assessed by technical evaluation to be PCN 40 and the maximum allowable tire pressure is 0.80 MPa, then the reported information would be:

PCN 40 / F / B / 0.80 MPa / T
-------------------------------

*Example 4* – If a pavement is subject to a B747-400 all-up mass limitation of 390,000kg, then the reported information would include the following note:

<i>The reported PCN is subject to a B747-400 all-up mass limitation of 390,000kg.</i>
---

5.6.8 Where overload operations are conducted, the aerodrome operator must review the relevant pavement condition and the criteria for overload operations.

5.6.9 The bearing strength of a pavement intended for aircraft of apron (ramp) mass equal to or less than 5,700kg must be made available to the AIS provider by reporting the following information:

- (a) maximum allowable aircraft mass; and
- (b) maximum allowable tire pressure.

Example: 4,000kg/0.50 MPa.
----------------------------

## **5.7 Pre-flight altimeter check location**

- 5.7.1 One or more pre-flight altimeter check locations must be established for an aerodrome.
- 5.7.2 The elevation of a pre-flight altimeter check location must be given as the average elevation, rounded to the nearest metre, of the area on which it is located. The elevation of any portion of a pre-flight altimeter check location must be within 3m of the average elevation for that location.

## **5.8 Declared distances**

- 5.8.1 The following declared distances must be calculated to the nearest metre for a runway intended for use by international commercial air transport:
  - (a) take-off run available (TORA);
  - (b) take-off distance available (TODA);
  - (c) accelerate-stop distance available (ASDA); and
  - (d) landing distance available (LDA).
- 5.8.2 Where a runway is provided with a clearway (CWY), then TODA must include the length of clearway as shown in Figure 5-1 (B).
- 5.8.3 Where a runway is provided with a stopway (SWY), then ASDA must include the length of stopway as shown in Figure 5-1 (C).
- 5.8.4 Where a runway has a displaced threshold, then the LDA must be reduced by the distance the threshold is displaced as shown in Figure 5-1 (D). A displaced threshold affects only the LDA for approach made to that threshold; all declared distances for operations in the reciprocal direction are unaffected.
- 5.8.5 Where more than one of the features (a runway provided with a clearway or a stopway or having a displaced threshold) exist, then more than one of the declared distances must be modified subject to the principle as illustrated in Figure 5-1.

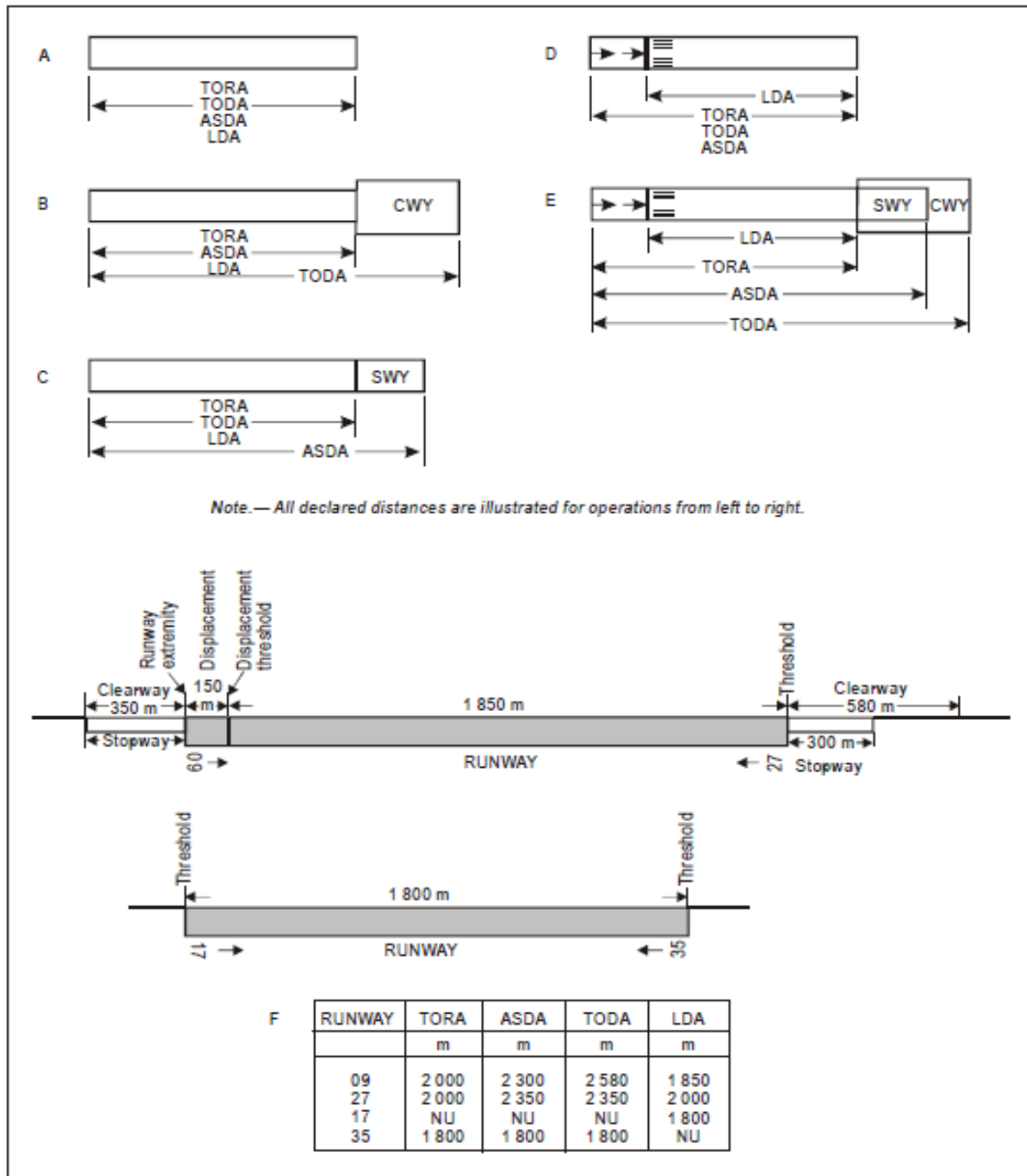

Figure 5-1 Illustration of declared distances

## 5.9 Condition of the movement area and related facilities

5.9.1 Information on the condition of the movement area and the operational status of related facilities must be provided to the AIS provider, and similar information of operational significance to the air traffic service (“ATS”) provider. The information<sup>15</sup> must be kept up-to-date and changes in conditions reported without delay.

<sup>15</sup> The nature, format and conditions of the information to be provided are specified in the PANS-AIM (Doc 10066) and the PANS-ATM (Doc 4444). Specific procedures pertaining to works in progress on the movement area and to the reporting of such works are specified in the PANS-Aerodromes (Doc 9981).

5.9.2 The condition of the movement area<sup>16</sup> and the operational status of related facilities must be monitored, and reports on matters of operational significance affecting aircraft and aerodrome operations must be provided to the AIS provider<sup>17</sup> and the ATS provider in order to take appropriate action, particularly in respect of the following:

- (a) construction or maintenance work;
- (b) rough or broken surfaces on a runway, taxiway or an apron;
- (c) water on a runway, a taxiway or an apron;
- (d) contaminants<sup>18</sup> on a runway, taxiway or apron;
- (e) other temporary hazards, including parked aircraft;
- (f) failure or irregular operation of part or all of the aerodrome visual aids; and
- (g) failure of the normal or secondary power supply.

5.9.3 To comply with paragraphs 5.9.1 and 5.9.2, the following inspections<sup>19</sup> must be carried out each day:

- (a) for the movement area, at least once where the aerodrome reference code number is 1 or 2 and at least twice where the aerodrome reference code number is 3 or 4; and
- (b) for the runway(s), inspections in addition to a) whenever the runway surface condition may have changed significantly<sup>20</sup> due to meteorological conditions.

5.9.4 Personnel<sup>21</sup> assessing, and reporting runway surface conditions required in 5.9.2 and 5.10.1 must be trained and competent to perform their duties.

---

<sup>16</sup> Procedures for monitoring and reporting the conditions of the movement area are included in the PANS-Aerodromes (Doc 9981). The ICAO Aeroplane Performance Manual (Doc 10064) provides guidance on aircraft performance calculation requirements regarding description of runway surface conditions in paragraphs 5.9.2(c) and (d).

<sup>17</sup> Origin and evolution of data, assessment process and the procedures are prescribed in the PANS-Aerodromes (Doc 9981). These procedures are intended to fulfil the requirements to achieve the desired level of safety for aeroplane operations prescribed by Annex 6 and Annex 8 and to provide the information fulfilling the syntax requirements for dissemination specified in Annex 15 and the PANS-ATM (Doc 4444).

<sup>18</sup> Contaminants may include mud, dust, sand, volcanic ash, oil, rubber.

<sup>19</sup> Procedures on carrying out daily inspections of the movement area are given in the ICAO PANS-Aerodromes (Doc 9981), Airport Services Manual (Doc 9137), Part 8, ICAO Manual of Surface Movement Guidance and Control Systems (SMGCS) (Doc 9476) and ICAO Advanced Surface Movement Guidance and Control Systems (A-SMGCS) Manual (Doc 9830).

<sup>20</sup> The ICAO PANS-Aerodromes (Doc 9981) contains clarifications on the scope of a significant change in the runway surface conditions.

<sup>21</sup> Guidance on training of personnel is given in ICAO Annex 14, Vol. 1, Attachment A, Section 6. Information on training for personnel assessing and reporting runway surface conditions is available in the ICAO PANS-Aerodromes (Doc 9981).

### **5.10 Runway surface condition for use in the runway condition report**

- 5.10.1 The certified operator must assess the runway surface condition<sup>22</sup> and provide the ATS provider and AIS provider each with a runway condition report which must specify a runway condition code (RWYCC) and a description using the terms “DRY”, “STANDING WATER” or “WET”.
- 5.10.2 Whenever an operational runway is contaminated, the certified operator must assess the contaminant depth and coverage<sup>23</sup> over each third of the runway and report its assessment to the ATS provider and AIS provider.
- 5.10.3 Information that a runway or a portion thereof is slippery wet must be made available to the aerodrome control tower<sup>24</sup>.
- 5.10.4 Notification must be given to relevant aerodrome users when the friction level<sup>25</sup> of a paved runway or portion thereof is less than the minimum friction level specified in Table 13-1.

### **5.11 Disabled aircraft removal**

- 5.11.1 The telephone/telefax number(s) of the office of the aerodrome coordinator of operations for the removal of an aircraft disabled on or adjacent to the movement area must be made available to aircraft operators.

### **5.12 Rescue and fire-fighting**

- 5.12.1 Information concerning the level of protection provided at an aerodrome for aircraft rescue and fire-fighting purposes must be made available to the AIS provider.
- 5.12.2 The level of protection normally available at the aerodrome must be expressed in terms of the category of the rescue and fire-fighting services as described in paragraph 12.1 and in accordance with the types and amounts of extinguishing agents normally available at the aerodrome.

---

<sup>22</sup> The runway surface conditions are those conditions for which, by means of the methods described in the ICAO PANS Aerodromes (Doc 9981), the flight crew can derive appropriate aeroplane performance. The conditions, either singly or in combination with other observations, are criteria for which the effect on aeroplane performance is sufficiently deterministic to allow assignment of a specific runway condition code.

<sup>23</sup> Procedures on depth and coverage reporting are found in the ICAO PANS-Aerodromes (Doc 9981).

<sup>24</sup> The surface friction characteristics of a runway or a portion thereof can be degraded due to rubber deposits, surface polishing, poor drainage or other factors. The determination that a runway or portion thereof is slippery wet stems from various methods used solely or in combination. These methods may be functional friction measurements, using a continuous friction measuring device, that fall below a minimum standard as defined by the DGCA, observations by aerodrome maintenance personnel, repeated reports by pilots and aircraft operators based on flight crew experience, or through analysis of aeroplane stopping performance that indicates a substandard surface. Supplementary tools to undertake this assessment are described in the ICAO PANS-Aerodromes (Doc 9981).

<sup>25</sup> Guidance on determining and expressing the minimum friction level is provided in ICAO Assessment, Measurement and Reporting of Runway Surface Conditions (Cir 355) and procedures on conducting a runway surface friction characteristics evaluation programme are provided in the ICAO PANS-Aerodromes (Doc 9981). Information to be promulgated in a NOTAM includes specifying which portion of the runway is below the minimum friction level and its location on the runway.

5.12.3 Changes<sup>26</sup> or corrections in the level of protection normally available per runway at an aerodrome for rescue and firefighting must be notified to the ATS provider and the AIS provider. When such a change has been corrected, the above units must be advised accordingly.

5.12.4 When a change in paragraph 5.12.3 is triggered, the change must be expressed in terms of the new category of the rescue and firefighting service available at the aerodrome.

### 5.13 Visual approach slope indicator systems

5.13.1 The following information concerning a visual approach slope indicator system installation must be made available to the AIS provider:

- (a) associated runway designation number;
- (b) type of system according to paragraph 8.3.4.2. For an AT-VASIS, PAPI or APAPI installation, the side of the runway on which the lights are installed, i.e. left or right, must be given;
- (c) where the axis of the system is not parallel to the runway centre line, the angle of displacement and the direction of displacement, i.e. left or right must be indicated;
- (d) nominal approach slope angle(s). For a T-VASIS or an AT-VASIS, this must be angle  $\theta$  according to the formula in Figure 8-15 and for a PAPI and an APAPI this must be angle  $(B+C)/2$  and  $(A+B)/2$ , respectively as in Figure 8-17; and
- (e) minimum edge height(s) over the threshold of the on-slope signal(s). For a T-VASIS or an AT-VASIS this must be the lowest height at which only the wing bar(s) are visible; however, the additional heights at which the wing bar(s) plus one, two or three fly down light units come into view may also be reported if such information would be of benefit to aircraft using the approach. For a PAPI, this must be the setting angle of the third unit from the runway minus  $2'$ , i.e. angle B minus  $2'$ , and for an APAPI this must be the setting angle of the unit farther from the runway minus  $2'$ , i.e. angle A minus  $2'$ .

---

<sup>26</sup> Changes in the level of protection from that normally available at the aerodrome could result from a change in the availability of extinguishing agents, equipment to deliver the agents or personnel to operate the equipment, etc.

## 6 Physical Characteristics

### 6.1 Runways

#### Width of runways

6.1.1 The width of a runway<sup>27</sup> must not be less than the appropriate dimension specified in the following tabulation:

Code number	Outer Main Gear Wheel Span (OMGWS) <sup>28</sup>			
	Up to but not including 4.5m	4.5m up to but not including 6m	6m up to but not including 9m	9m up to but not including 15m
1 <sup>a</sup>	18 m	18 m	23 m	-
2 <sup>a</sup>	23 m	23 m	30 m	-
3	30 m	30 m	30 m	45 m
4	-	-	45 m	45 m

<sup>a</sup> The width of a precision approach runway must be not less than 30 m where the code number is 1 or 2.

#### Minimum distance between parallel runways

6.1.2 Where parallel non-instrument runways are intended for simultaneous use, the minimum distance<sup>29</sup> between their centre lines must be:

- 210 m where the higher code number is 3 or 4;
- 150 m where the higher code number is 2; and
- 120 m where the higher code number is 1.

6.1.3 Where parallel instrument runways are intended for simultaneous use<sup>30</sup> subject to conditions specified in the ICAO PANS-ATM (Doc 4444) and the ICAO PANS-OPS (Doc 8168), Volume I, the minimum distance between their centre lines must be:

- 1 035 m for independent parallel approaches;
- 915 m for dependent parallel approaches;

<sup>27</sup> Factors affecting runway width are given in the ICAO Aerodrome Design Manual (Doc 9157), Part 1. See paragraph 6.2 concerning the provision of runway shoulders, in particular for Code F aeroplanes with four (or more) engines.

<sup>28</sup> The combinations of code numbers and OMGWS for which widths are specified have been developed for typical aeroplane characteristics.

<sup>29</sup> Procedures for wake turbulence categorization of aircraft and wake turbulence separation minima are contained in the ICAO Procedures for Air Navigation Services — Air Traffic Management (PANS-ATM) (Doc 4444), Chapter 4, 4.9 and Chapter 5, 5.8, respectively.

<sup>30</sup> Procedures and facilities requirements for simultaneous operations on parallel or near-parallel instrument runways are contained in the ICAO PANS-ATM (Doc 4444), Chapter 6 and the ICAO PANS-OPS (Doc 8168), Volume I, Part III, Section 2 and Volume II, Part I, Section 3; Part II, Section 1; and Part III, Section 3, and relevant guidance is contained in the ICAO Manual of Simultaneous Operations on Parallel or Near-Parallel Instrument Runways (Doc 9643).



- 760 m for independent parallel departures;
- 760 m for segregated parallel operations;

except that:

- (a) for segregated parallel operations the specified minimum distance:
  - (1) may be decreased by 30 m for each 150 m that the arrival runway is staggered toward the arriving aircraft, to a minimum of 300 m; and
  - (2) should be increased by 30 m for each 150 m that the arrival runway is staggered away from the arriving aircraft;
- (b) for independent parallel approaches, combinations of minimum distances and associated conditions other than those specified in the ICAO PANS-ATM (Doc 4444) may be applied when it is determined that such combinations would not adversely affect the safety of aircraft operations.

### Slopes on runways

#### *Longitudinal slopes*

6.1.4 The slope computed by dividing the difference between the maximum and minimum elevation along the runway centre line by the runway length must not exceed:

- 1 per cent where the code number is 3 or 4; and
- 2 per cent where the code number is 1 or 2.

6.1.5 Along no portion of a runway must the longitudinal slope exceed:

- 1.25 per cent where the code number is 4, except that for the first and last quarter of the length of the runway the longitudinal slope must not exceed 0.8 per cent;
- 1.5 per cent where the code number is 3, except that for the first and last quarter of the length of a precision approach runway category II or III the longitudinal slope must not exceed 0.8 per cent; and
- 2 per cent where the code number is 1 or 2.

#### *Longitudinal slope changes*

6.1.6 Where slope changes<sup>31</sup> cannot be avoided, a slope change between two consecutive slopes must not exceed:

- 1.5 per cent where the code number is 3 or 4; and
- 2 per cent where the code number is 1 or 2.

---

<sup>31</sup> Guidance on slope changes before a runway is given in ICAO Annex 14 Vol. I, Attachment A, Section 4.

6.1.7 The transition from one slope to another must be accomplished by a curved surface with a rate of change not exceeding:

- 0.1 per cent per 30 m (minimum radius of curvature of 30,000 m) where the code number is 4;
- 0.2 per cent per 30 m (minimum radius of curvature of 15,000 m) where the code number is 3; and
- 0.4 per cent per 30 m (minimum radius of curvature of 7,500 m) where the code number is 1 or 2.

*Sight distance*

6.1.8 Where slope changes<sup>32</sup> cannot be avoided, they must be such that there will be an unobstructed line of sight from:

- any point 3 m above a runway to all other points 3 m above the runway within a distance of at least half the length of the runway where the code letter is C, D, E or F.
- any point 2 m above a runway to all other points 2 m above the runway within a distance of at least half the length of the runway where the code letter is B; and
- any point 1.5 m above a runway to all other points 1.5 m above the runway within a distance of at least half the length of the runway where the code letter is A.

*Distance between slope changes*

6.1.9 Undulations or appreciable changes<sup>33</sup> in slopes located close together along a runway must be avoided. The distance between the points of intersection of two successive curves must not be less than:

- (a) the sum of the absolute numerical values of the corresponding slope changes multiplied by the appropriate value as follows:
  - 30,000 m where the code number is 4;
  - 15,000 m where the code number is 3; and
  - 5,000 m where the code number is 1 or 2; or
- (b) 45 m;

whichever is greater.

---

<sup>32</sup> Consideration will have to be given to providing an unobstructed line of sight over the entire length of a single runway where a full-length parallel taxiway is not available. Where an aerodrome has intersecting runways, additional criteria on the line of sight of the intersection area would need to be considered for operational safety. See the ICAO Aerodrome Design Manual (Doc 9157), Part 1.

<sup>33</sup> Guidance on implementing this specification is given in ICAO Annex 14 Vol. I, Attachment A, Section 4.

### Transverse slopes

- 6.1.10 The transverse slope<sup>34</sup> must be substantially the same throughout the length of a runway except at an intersection with another runway or a taxiway where an even transition must be provided taking account of the need for adequate drainage.

### Strength of runways

- 6.1.11 A runway must be capable of withstanding the traffic of aeroplanes the runway is intended to serve.

### Surface of runways

- 6.1.12 The surface<sup>35</sup> of a runway must be constructed without irregularities that would impair the runway surface friction characteristics or otherwise adversely affect the take-off or landing of an aeroplane.
- 6.1.13 A paved runway must be so constructed or resurfaced as to provide surface friction characteristics at or above the minimum friction level specified in Table 13-1.
- 6.1.14 Measurements of the surface friction characteristics<sup>36</sup> of a new or resurfaced paved runway must be made with a continuous friction measuring device using self-wetting features.

## **6.2 Runway shoulders**

- 6.2.1 Runway shoulders must be provided for a runway where the code letter is D, E or F.

### Slopes on runway shoulders

- 6.2.2 The surface of the shoulder that abuts the runway must be flush with the surface of the runway and its transverse slope must not exceed 2.5 per cent.

### Strength<sup>37</sup> of runway shoulders

- 6.2.3 The portion of a runway shoulder between the runway edge and a distance of 30m from the runway centreline must be prepared or constructed so as to be capable, in the event of an aeroplane running off the runway, of supporting the aeroplane without inducing structural damage to the aeroplane and of supporting ground vehicles which may operate on the shoulder.

---

<sup>34</sup> Guidance on transverse slope is given in the ICAO Aerodrome Design Manual (Doc 9157), Part 3.

<sup>35</sup> Surface irregularities may adversely affect the take-off or landing of an aeroplane by causing excessive bouncing, pitching, vibration, or other difficulties in the control of an aeroplane. Guidance on design tolerances and other information is given in ICAO Annex 14 Vol. I, Attachment A, Section 5. Additional guidance is included in the ICAO Aerodrome Design Manual (Doc 9157), Part 3.

<sup>36</sup> Additional guidance is included in the ICAO Airport Services Manual (Doc 9137), Part 2.

<sup>37</sup> Guidance on strength of runway shoulders is given in the ICAO Aerodrome Design Manual (Doc 9157), Part 1.

### 6.3 Runway turn pads

- 6.3.1 Where the end of a runway is not served by a taxiway or a taxiway turnaround and where the code is D, E or F, a runway turn pad must be provided to facilitate a 180-degree turn for aeroplanes (See Figure 6-1)

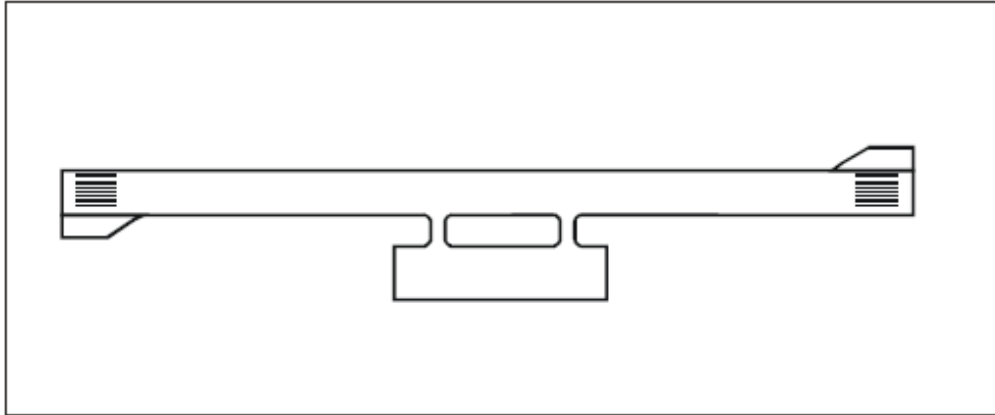

Figure 6-1. Typical turn pad layout

- 6.3.2 The design of a runway turn pad must be such that, when the cockpit of the aeroplane for which the turn pad is intended remains over the turn pad marking, the clearance distance between any wheel of the aeroplane landing gear and the edge of the turn pad must be not less than that given by the following tabulations:

<b>OMGWS</b>				
	Up to but not including 4.5m	4.5m up to but not including 6m	6m up to but not including 9m	9m up to but not including 15m
Clearance	1.50m	2.25m	3m <sup>a</sup> or 4m <sup>b</sup>	4m

<sup>a</sup> If the turn pad is intended to be used by aeroplanes with a wheel base less than 18m.

<sup>b</sup> If the turn pad is intended to be used by aeroplanes with a wheel base equal to or greater than 18m.

Note – Wheel base means the distance from the nose gear to the geometric centre of the main gear.

#### Surface of runway turn pads

- 6.3.3 The surface of a runway turn pad must not have surface irregularities that may cause damage to an aeroplane using the turn pad.

### 6.4 Runway strips

- 6.4.1 A runway and any associated stopways must be included in a strip.

#### Length of runway strips

- 6.4.2 A strip must extend before the threshold and beyond the end of the runway or stopway for a distance of at least:

- 60 m where the code number is 2, 3 or 4;
- 60 m where the code number is 1 and the runway is an instrument one; and
- 30 m where the code number is 1 and the runway is a non-instrument one.

#### Width of runway strips

- 6.4.3 A strip including a precision approach runway must extend laterally to a distance of at least:
- 140 m where the code number is 3 or 4; and
  - 70 m where the code number is 1 or 2;
- on each side of the centre line of the runway and its extended centre line throughout the length of the strip.
- 6.4.4 A strip including a non-precision approach runway must extend laterally to a distance of at least:
- 140 m where the code number is 3 or 4; and
  - 70 m where the code number is 1 or 2;
- on each side of the centre line of the runway and its extended centre line throughout the length of the strip.
- 6.4.5 A strip including a non-instrument runway must extend on each side of the centre line of the runway and its extended centre line throughout the length of the strip, to a distance of at least:
- 75 m where the code number is 3 or 4;
  - 40 m where the code number is 2; and
  - 30 m where the code number is 1.

#### Objects on runway strips

- 6.4.6 An object<sup>38</sup> situated on a runway strip which may endanger aeroplanes must be regarded as an obstacle and must be removed.
- 6.4.7 No fixed object, other than visual aids required for air navigation or those required for aircraft safety purposes and which must be sited on the runway strip, and satisfying the relevant frangibility requirement in Chapter 8, must be permitted on any part of a runway strip of a precision approach runway delineated by the lower edges of the inner transitional surfaces<sup>39</sup>. No mobile object must be permitted on this part of the runway strip during the use of the runway for landing or take-off.

#### Grading of runway strips

- 6.4.8 That portion of a strip of an instrument runway within a distance of at least:
- 75 m where the code number is 3 or 4; and
  - 40 m where the code number is 1 or 2;

---

<sup>38</sup> Consideration will have to be given to the location and design of drains on a runway strip to prevent damage to an aeroplane accidentally running off a runway. Suitably designed drain covers may be required. For further guidance, see ICAO Aerodrome Design Manual (Doc 9157), Part 1. Where open-air or covered storm water conveyances are installed, consideration will have to be given to ensure that their structure does not extend above the surrounding ground so as not to be considered an obstacle. See also footnote to paragraph 6.4.15. Particular attention needs to be given to the design and maintenance of an open-air storm water conveyance in order to prevent wildlife attraction, notably birds. If needed, it can be covered by a net. Procedures on wildlife management are specified in the ICAO PANS-Aerodrome (Doc 9981). Further guidance can be found in the ICAO Airport Services Manual (Doc 9137), Part 3.

<sup>39</sup> See Chapter 7, paragraph 7.1 for characteristics of inner transitional surface

from the centre line of the runway and its extended centre line must provide a graded<sup>40</sup> area for aeroplanes which the runway is intended to serve in the event of an aeroplane running off the runway.

- 6.4.9 That portion of a strip of a non-instrument runway within a distance of at least:
- 75 m where the code number is 3 or 4;
  - 40 m where the code number is 2; and
  - 30 m where the code number is 1;
- from the centre line of the runway and its extended centre line must provide a graded area for aeroplanes which the runway is intended to serve in the event of an aeroplane running off the runway.
- 6.4.10 The surface of that portion of a strip that abuts a runway, shoulder or stopway must be flush with the surface of the runway, shoulder or stopway.
- 6.4.11 That portion of a strip to at least 30 m before the start of a runway must be prepared against blast erosion<sup>41</sup> in order to protect a landing aeroplane from the danger of an exposed edge.

#### Slopes on runway strips

##### 6.4.12 Longitudinal slopes

A longitudinal slope along that portion of a strip to be graded must not exceed:

- 1.5 per cent where the code number is 4;
- 1.75 per cent where the code number is 3; and
- 2 per cent where the code number is 1 or 2.

##### 6.4.13 Longitudinal slope changes

Slope changes on that portion of a strip to be graded must be as gradual as practicable and abrupt changes or sudden reversals of slopes avoided.

##### 6.4.14 Transverse slopes

Transverse slopes on that portion of a strip to be graded must be adequate to prevent the accumulation of water on the surface but must not exceed:

- 2.5 per cent where the code number is 3 or 4; and
- 3 per cent where the code number is 1 or 2;

except that to facilitate drainage the slope for the first 3 m outward from the runway, shoulder or stopway edge must be negative as measured in the direction away from the runway and may be as great as 5 per cent.

- 6.4.15 The transverse slopes of any portion of a strip beyond that to be graded<sup>42</sup> must not exceed an upward slope of 5 per cent as measured in the direction away from the runway.

---

<sup>40</sup> Guidance on grading of a greater area of a strip including a precision approach runway where the code number is 3 or 4 is given in ICAO Annex 14 Vol. I, Attachment A, Section 8.

<sup>41</sup> The area provided to reduce the erosive effects of jet blast and propeller wash may be referred to as a blast pad. Guidance on protection against aeroplane engine blast is available in the ICAO Aerodrome Design Manual (Doc 9157), Part 2.

<sup>42</sup> Where deemed necessary for proper drainage, an open-air storm water conveyance may be allowed in the non-graded portion of a runway strip and would be placed as far as practicable from the runway. The aerodrome

Strength of runway strips

- 6.4.16 That portion of a strip<sup>43</sup> of an instrument runway within a distance of at least:
- 75 m where the code number is 3 or 4; and
  - 40 m where the code number is 1 or 2;

from the centre line of the runway and its extended centre line must be so prepared or constructed as to minimize hazards arising from differences in load bearing capacity to aeroplanes which the runway is intended to serve in the event of an aeroplane running off the runway.

- 6.4.17 That portion of a strip containing a non-instrument runway within a distance of at least:

- 75 m where the code number is 3 or 4;
- 40 m where the code number is 2; and
- 30 m where the code number is 1;

from the centre line of the runway and its extended centre line must be so prepared or constructed as to minimize hazards arising from differences in load bearing capacity to aeroplanes which the runway is intended to serve in the event of an aeroplane running off the runway.

**6.5 Runway end safety areas**

- 6.5.1 A runway end safety area<sup>44</sup> must be provided at each end of a runway strip where:
- the code number is 3 or 4; and
  - the code number is 1 or 2 and the runway is an instrument one.

Dimensions of runway end safety areas

- 6.5.2 A runway end safety area must extend from the end of a runway strip to a distance of at least 90 m where:

- the code number is 3 or 4; and
- the code number is 1 or 2 and the runway is an instrument one.

If an arresting system<sup>45</sup> is installed, the above length may be reduced, based on the design specification of the system, subject to acceptance by the DGCA.

- 6.5.3 The width of a runway end safety area must be at least twice that of the associated runway.

---

RFF procedure would need to take into account the location of open-air water conveyances within the non-graded portion of a runway strip.

<sup>43</sup> Guidance on preparation of runway strips is given in the ICAO Aerodrome Design Manual (Doc 9157), Part 1.

<sup>44</sup> Guidance on runway end safety areas is given in ICAO Annex 14 Vol. I, Attachment A, Section 9.

<sup>45</sup> Guidance on arresting systems is given in ICAO Annex 14, Vol. I, Attachment A, Section 9.

Objects on runway end safety areas

- 6.5.4 An object situated on a runway end safety area<sup>46</sup> which may endanger aeroplanes must be regarded as an obstacle and must be removed.

Clearing and grading of runway end safety areas

- 6.5.5 A runway end safety area<sup>47</sup> must provide a cleared and graded area for aeroplanes which the runway is intended to serve in the event of an aeroplane undershooting or overrunning the runway.

Slopes on runway end safety areas

- 6.5.6 The slopes of a runway end safety area must be such that no part of the runway end safety area penetrates the approach or take-off climb surface.

6.5.7 Longitudinal slopes

The longitudinal slopes of a runway end safety area must not exceed a downward slope of 5 per cent. Longitudinal slope changes must be as gradual as practicable and abrupt changes or sudden reversals of slopes avoided.

6.5.8 Transverse slopes

The transverse slopes of a runway end safety area must not exceed an upward or downward slope of 5 per cent. Transitions between differing slopes must be as gradual as practicable.

Strength<sup>48</sup> of runway end safety areas

- 6.5.9 A runway end safety area must be so prepared or constructed as to reduce the risk of damage to an aeroplane undershooting or overrunning the runway, enhance aeroplane deceleration and facilitate the movement of rescue and fire fighting vehicles as required in paragraphs 12.1.24 to 12.1.25.

**6.6 Clearways**

- 6.6.1 The inclusion of detailed specifications for clearways in this section is not intended to imply that a clearway has to be provided. ICAO Annex 14 Vol. I, Attachment A, Section 2 provides information on the use of clearways.

Location of clearways

- 6.6.2 The origin of a clearway must be at the end of the take-off run available.

Length of clearways

- 6.6.3 The length of a clearway must not exceed half the length of the take-off run available.

---

<sup>46</sup> See section 12.5 for information regarding siting of equipment and installations on runway end safety areas.

<sup>47</sup> The surface of the ground in the runway end safety area does not need to be prepared to the same quality as the runway strip. See, however, paragraph 6.5.9.

<sup>48</sup> Guidance on strength of a runway end safety area is given in the ICAO Aerodrome Design Manual (Doc 9157), Part 1.



### Slopes on clearways

- 6.6.4 The ground in a clearway must not project above a plane having an upward slope of 1.25 per cent, the lower limit<sup>49</sup> of this plane being a horizontal line which:
- (a) is perpendicular to the vertical plane containing the runway centre line; and
  - (b) passes through a point located on the runway centre line at the end of the take-off run available.
- 6.6.5 Abrupt upward changes in slope must be avoided when the slope on the ground in a clearway is relatively small or when the mean slope is upward. In such situations, in that portion of the clearway within a distance of 22.5 m or half the runway width whichever is greater on each side of the extended centre line, the slopes, slope changes and the transition from runway to clearway must generally conform with those of the runway with which the clearway is associated.

### Objects on clearways

- 6.6.6 An object situated on a clearway which may endanger aeroplanes in the air must be regarded as an obstacle and must be removed.

## **6.7 Stopways**

- 6.7.1 The inclusion of detailed specifications for stopways in this section is not intended to imply that a stopway has to be provided. ICAO Annex 14 Vol. I, Attachment A, Section 2 provides information on the use of stopways.

### Width of stopways

- 6.7.2 A stopway must have the same width as the runway with which it is associated.

### Slopes on stopways

- 6.7.3 Slopes and changes in slope on a stopway, and the transition from a runway to a stopway, must comply with the specifications of paragraphs 6.1.4 to 6.1.9 for the runway with which the stopway is associated except that:
- (a) the limitation in paragraph 6.1.5 of a 0.8 per cent slope for the first and last quarter of the length of a runway need not be applied to the stopway; and
  - (b) at the junction of the stopway and runway and along the stopway the maximum rate of slope change may be 0.3 per cent per 30 m (minimum radius of curvature of 10,000 m) for a runway where the code number is 3 or 4.

---

<sup>49</sup> Because of transverse or longitudinal slopes on a runway, shoulder or strip, in certain cases the lower limit of the clearway plane specified above may be below the corresponding elevation of the runway, shoulder or strip. It is not intended that these surfaces be graded to conform with the lower limit of the clearway plane nor is it intended that terrain or objects which are above the clearway plane beyond the end of the strip but below the level of the strip be removed unless it is considered they may endanger aeroplanes.

Strength of stopways

- 6.7.4 A stopway<sup>50</sup> must be prepared or constructed so as to be capable, in the event of an abandoned take-off, of supporting the aeroplane which the stopway is intended to serve without inducing structural damage to the aeroplane.

Surface of stopways

- 6.7.5 The surface of a paved stopway must be so constructed or resurfaced as to provide surface friction characteristics at or above those of the associated runway.

**6.8 Radio altimeter operating area**Length of the area

- 6.8.1 A radio altimeter operating area must extend before the threshold for a distance of at least 300 m.

**6.9 Taxiways<sup>51</sup>**

- 6.9.1 Taxiways<sup>52</sup> must be provided to permit the safe and expeditious surface movement of aircraft.

- 6.9.2 The design of a taxiway must be such that, when the cockpit of the aeroplane for which the taxiway is intended remains over the taxiway centre line markings, the clearance distance between the outer main wheel of the aeroplane and the edge of the taxiway must be not less than that given by the following tabulation:

OMGWS				
	Up to but not including 4.5m	4.5m up to but not including 6m	6m up to but not including 9m	9m up to but not including 15m
Clearance	1.50m	2.25m	3m <sup>a,b</sup> or 4m <sup>c</sup>	4m

<sup>a</sup> On straight portions.

<sup>b</sup> On curved portions if the taxiway is intended to be used by aeroplanes with a wheel base of less than 18m.

<sup>c</sup> On curved portions if the taxiway is intended to be used by aeroplanes with a wheel base equal to or greater than 18m.

Note — Wheel base means the distance from the nose gear to the geometric centre of the main gear.

<sup>50</sup> ICAO Annex 14 Vol. I, Attachment A, Section 2 presents guidance relative to the support capability of a stopway

<sup>51</sup> Unless otherwise indicated, the requirements in this section are applicable to all types of taxiways. See paragraph 8.4.3 for a standardised scheme for the nomenclature of taxiways which may be used to improve situational awareness and as a part of an effective runway incursion prevention measure. See ICAO Annex 14 Vol. I, Attachment A, Section 21 for specific taxiway design guidance which may assist in the prevention of runway incursions when developing a new taxiway or improving existing ones with a known runway incursion safety risk.

<sup>52</sup> Guidance on layout and standardised nomenclature of taxiways is given in the ICAO Aerodrome Design Manual (Doc 9157), Part 2.

Width of taxiways

- 6.9.3 A straight portion of a taxiway must have a width<sup>53</sup> of not less than that given by the following tabulation:

<b>OMGWS</b>				
	Up to but not including 4.5m	4.5m up to but not including 6m	6m up to but not including 9m	9m up to but not including 15m
Taxiway width	<i>7.5m</i>	<i>10.5m</i>	<i>15m</i>	<i>23m</i>

Taxiway minimum separation distances

- 6.9.4 The separation distance between the centre line of a taxiway and the centre line of a runway, the centre line of a parallel taxiway or an object must not be less than the appropriate dimension specified in Table 6-1, except that it may be permissible to operate with lower separation distances at an existing aerodrome if an aeronautical study<sup>54</sup> indicates that such lower separation distances would not adversely affect the safety or significantly affect the regularity of operations of aeroplanes.

Table 6-1 – Taxiway minimum separation distances

Code letter	Distance between taxiway centre line and runway centre line (metres)								Taxiway centre line to taxiway centre line (metres)	Taxiway, other than aircraft stand taxilane, centre line to object (metres)	Aircraft stand taxilane centre line to aircraft stand taxilane centre line (metres)	Aircraft stand taxilane centre line to object (metres)
	Instrument runways				Non-instrument runways							
	Code number				Code number							
	1	2	3	4	1	2	3	4				
(1)	(2)	(3)	(4)	(5)	(6)	(7)	(8)	(9)	(10)	(11)	(12)	(13)
A	77.5	77.5	-	-	37.5	47.5	-	-	23	15.5	19.5	12
B	82	82	152	-	42	52	87	-	32	20	28.5	16.5
C	88	88	158	158	48	58	93	93	44	26	40.5	22.5
D	-	-	166	166	-	-	101	101	63	37	59.5	33.5
E	-	-	172.5	172.5	-	-	107.5	107.5	76	43.5	72.5	40
F	-	-	180	180	-	-	115	115	91	51	87.5	47.5

<sup>53</sup> Guidance on width of taxiways is given in the ICAO Aerodrome Design Manual (Doc 9157), Part 2.

<sup>54</sup> Guidance on factors which may be considered in the aeronautical study is given in the ICAO Aerodrome Design Manual (Doc 9157), Part 2. ILS and MLS installations may also influence the location of taxiways due to interferences to ILS and MLS signals by a taxiing or stopped aircraft. Information on critical and sensitive areas surrounding ILS and MLS installations is contained in ICAO Annex 10, Volume I, Attachments C and G (respectively).

	<i>Note 1 – The separation distances shown in columns (2) to (9) represent ordinary combinations of runways and taxiways. The basis for development of these distances is given in the ICAO Aerodrome Design Manual (Doc 9157), Part 2.</i>
	<i>Note 2 – The distances in columns (2) to (9) do not guarantee sufficient clearance behind a holding aeroplane to permit the passing of another aeroplane on a parallel taxiway. See ICAO Aerodrome Design Manual (Doc 9157), Part 2.</i>
	<i>Note 3 - The separation distances shown in column (10), do not necessarily provide the capability of making a normal turn from one taxiway to another parallel taxiway. Guidance for this condition is given in the ICAO Aerodrome Design Manual (Doc 9157), Part 2.</i>
	<i>Note 4 - The separation distance between the centre line of an aircraft stand taxilane and an object shown in column (13), may need to be increased when jet exhaust wake velocity may cause hazardous conditions for ground servicing.</i>

### Slopes on taxiways

#### 6.9.5 Longitudinal slopes

The longitudinal slope of a taxiway must not exceed:

- 1.5 per cent where the code letter is C, D, E or F; and
- 3 per cent where the code letter is A or B.

#### 6.9.6 Longitudinal slope changes

Where slope changes on a taxiway cannot be avoided, the transition from one slope to another slope must be accomplished by a curved surface with a rate of change not exceeding:

- 1 per cent per 30 m (minimum radius of curvature of 3 000 m) where the code letter is C, D, E or F; and
- 1 per cent per 25 m (minimum radius of curvature of 2 500 m) where the code letter is A or B.

#### 6.9.7 Sight distance

Where a change in slope on a taxiway cannot be avoided, the change must be such that, from any point:

- 3 m above the taxiway, it will be possible to see the whole surface of the taxiway for a distance of at least 300 m from that point, where the code letter is C, D, E or F;
- 2 m above the taxiway, it will be possible to see the whole surface of the taxiway for a distance of at least 200 m from that point, where the code letter is B; and
- 1.5 m above the taxiway, it will be possible to see the whole surface of the taxiway for a distance of at least 150 m from that point, where the code letter is A.

#### 6.9.8 Transverse slopes

The transverse slopes of a taxiway must be sufficient to prevent the accumulation of water on the surface of the taxiway but must not exceed:

- 1.5 per cent where the code letter is C, D, E or F; and
- 2 per cent where the code letter is A or B.

### Strength of taxiways

6.9.9 The strength<sup>55</sup> of a taxiway must be at least equal to that of the runway it serves, due consideration being given to the fact that a taxiway will be subjected to a greater density of traffic and, as a result of slow moving and stationary aeroplanes, to higher stresses than the runway it serves.

### Rapid exit taxiways

6.9.10 The following specifications detail requirements particular to rapid exit taxiways. See Figure 6-2. General requirements for taxiways also apply to this type of taxiway. Guidance on the provision, location and design of rapid exit taxiways is included in the ICAO Aerodrome Design Manual, Part 2.

6.9.11 A rapid exit taxiway<sup>56</sup> must be designed with a radius of turn-off curve of at least:

- 550 m where the code number is 3 or 4; and
- 275 m where the code number is 1 or 2;

to enable exit speeds under wet conditions of:

- 93 km/h where the code number is 3 or 4; and
- 65 km/h where the code number is 1 or 2.

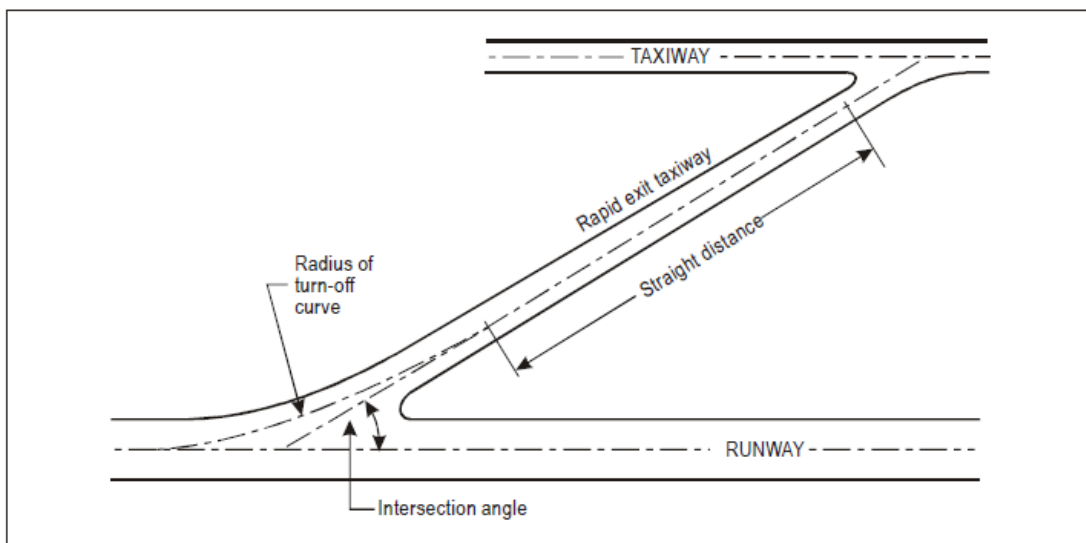

Figure 6-2. Rapid exit taxiway

### Taxiways on bridges

6.9.12 The width of that portion of a taxiway bridge capable of supporting aeroplanes, as measured perpendicularly to the taxiway centre line, must not be less than the width of the graded area of the strip provided for that taxiway, unless a proven method of lateral restraint is provided which must not be hazardous for aeroplanes for which the taxiway is intended.

---

<sup>55</sup> Guidance on the relation of the strength of taxiways to the strength of runways is given in the ICAO Aerodrome Design Manual (Doc 9157), Part 3.

<sup>56</sup> The locations of rapid exit taxiways along a runway are based on several criteria described in the ICAO Aerodrome Design Manual (Doc 9157), Part 2, in addition to different speed criteria.

6.9.13 Access must be provided to allow rescue and fire fighting vehicles to intervene in both directions within the specified response time to the largest aeroplane<sup>57</sup> for which the taxiway bridge is intended.

6.9.14 A bridge must be constructed on a straight section of the taxiway with a straight section on both ends of the bridge to facilitate the alignment of aeroplanes approaching the bridge.

## **6.10 Taxiway shoulders**

6.10.1 The surface of the taxiway shoulder<sup>58</sup> intended to be used by turbine-engined aeroplanes must be so prepared as to resist erosion and the ingestion of the surface material by aeroplane engines.

## **6.11 Taxiway strips**

6.11.1 A taxiway, other than an aircraft stand taxiway, must be included in a strip<sup>59</sup>.

### Width of taxiway strips

6.11.2 A taxiway strip must extend symmetrically on each side of the centre line of the taxiway throughout the length of the taxiway to at least the distance from the centre line given in Table 6-1, column 11.

### Objects on taxiway strips

6.11.3 The taxiway strip must provide an area clear of objects<sup>60</sup> which may endanger taxiing aeroplanes.

### Grading of taxiway strips

6.11.4 The centre portion of a taxiway strip must provide a graded area<sup>61</sup> to a distance from the centre line of the taxiway of not less than that given by the following tabulation:

- 10.25 m where the OMGWS is up to but not including 4.5m;
- 11 m where the OMGWS is 4.5m up to but not including 6m;
- 12.50 m where the OMGWS is 6m up to but not including 9m;

---

<sup>57</sup> If aeroplane engines overhang the bridge structure, protection of adjacent areas below the bridge from engine blast may be required

<sup>58</sup> Guidance on characteristics of taxiway shoulders and on shoulder treatment is given in the ICAO Aerodrome Design Manual (Doc 9157), Part 2.

<sup>59</sup> Guidance on characteristics of taxiway strips is given in the ICAO Aerodrome Design Manual (Doc 9157), Part 2.

<sup>60</sup> See paragraph 12.5 for information regarding siting of equipment and installations on taxiway strips. Consideration will have to be given to the location and design of drains on a taxiway strip to prevent damage to an aeroplane accidentally running off a taxiway. Suitably designed drain covers may be required. For further guidance, see the Aerodrome Design Manual (Doc 9157), Part 2. Where open-air or covered storm water conveyances are installed, consideration will have to be given to ensure that their structure do not extend above the surrounding ground so as not to be considered an obstacle. See also footnote to 6.11.6. Particular attention needs to be given to the design and maintenance of an open-air storm water conveyance in order to prevent wildlife attraction, notably birds. If needed, it can be covered by a net. Guidance on Wildlife Control and Reduction can be found in the Airport Services Manual (Doc 9137), Part 3.

<sup>61</sup> Guidance on width of the graded portion of a taxiway is given in the Aerodrome Design manual (Doc 9157), Part 2.

- 18.50 m where the OMGWS is 9m up to but not including 15m, where the code letter is D;
- 19 m where the OMGWS is 9m up to but not including 15m, where the code letter is E;
- 22 m where the OMGWS is 9m up to but not including 15m, where the code letter is F.

#### Slopes on taxiway strips

6.11.5 The surface of the strip must be flush at the edge of the taxiway or shoulder, if provided, and the graded portion must not have an upward transverse slope exceeding:

- 2.5 per cent for strips where the code letter is C, D, E or F; and
- 3 per cent for strips of taxiways where the code letter is A or B;

the upward slope being measured with reference to the transverse slope of the adjacent taxiway surface and not the horizontal. The downward transverse slope must not exceed 5 per cent measured with reference to the horizontal.

6.11.6 The transverse slopes<sup>62</sup> on any portion of a taxiway strip beyond that to be graded must not exceed an upward or downward slope of 5 per cent as measured in the direction away from the taxiway.

### **6.12 Holding bays, runway-holding positions, intermediate holding positions and road-holding positions**

6.12.1 A runway-holding position or positions must be established:

- (a) on the taxiway, at the intersection of a taxiway and a runway; and
- (b) at an intersection of a runway with another runway when the former runway is part of a standard taxi-route.

6.12.2 A runway-holding position must be established on a taxiway if the location or alignment of the taxiway is such that a taxiing aircraft or vehicle can infringe an obstacle limitation surface or interfere with the operation of radio navigation aids.

6.12.3 A road-holding position must be established at an intersection of a road with a runway.

---

<sup>62</sup> Where deemed necessary for proper drainage, an open-air storm water conveyance may be allowed in the non-graded portion of a taxiway strip and would be placed as far as practicable from the taxiway. The aerodrome RFF procedure would need to take into account the location of open-air storm water conveyances within the non-graded portion of a taxiway strip.

Location

6.12.4 The distance between a holding bay, runway-holding position<sup>63</sup> established at a taxiway/runway intersection or road-holding position and the centre line of a runway must be in accordance with Table 6-2 and, in the case of a precision approach runway, such that a holding aircraft or vehicle will not interfere with the operation of radio navigation aids or penetrate the inner transitional surface.

Table 6-2 – Minimum distance from the runway centre line to a holding bay, runway-holding position or road-holding position

Type of runway	Code number			
	1	2	3	4
Non-instrument	30 m	40 m	75 m	75 m
Non-precision approach	40 m	40 m	75 m	75 m
Precision approach category I	60 m <sup>b</sup>	60 m <sup>b</sup>	90 m <sup>a,b</sup>	90 m <sup>a,b</sup>
Precision approach categories II and III	-	-	90 m <sup>a,b</sup>	90 m <sup>a,b</sup>
Take-off runway	30 m	40 m	75 m	75 m
<p>a. If a holding bay, runway-holding position or road-holding position is at a lower elevation compared to the threshold, the distance may be decreased 5 m for every metre the bay or holding position is lower than the threshold, contingent upon not infringing the inner transitional surface.</p> <p>b. This distance may need to be increased to avoid interference with radio navigation aids, particularly the glide path and localizer facilities. Information on critical and sensitive areas of ILS and MLS is contained in ICAO Annex 10, Volume I, Attachments C and G, respectively (See also paragraph 6.12.4).</p> <p>Note 1 — The distance of 90 m for code number 3 or 4 is based on an aircraft with a tail height of 20 m, a distance from the nose to the highest part of the tail of 52.7 m and a nose height of 10 m holding at an angle of 45° or more with respect to the runway centre line, being clear of the obstacle free zone and not accountable for the calculation of OCA/H.</p> <p>Note 2 — The distance of 60 m for code number 2 is based on an aircraft with a tail height of 8 m, a distance from the nose to the highest part of the tail of 24.6 m and a nose height of 5.2 m holding at an angle of 45° or more with respect to the runway centre line, being clear of the obstacle free zone.</p> <p>Note 3 — For code number 4 where the width of the inner edge of the inner approach surface is more than 120m, a distance greater than 90m may be necessary to ensure that a holding aircraft is clear of the obstacle free zone. For example, a distance of 100 m is based on an aircraft with a tail height of 24 m, a distance from the nose to the highest part of the tail of 62.2 m and a nose height of 10 m holding at an angle of 45° or more with respect to the runway centre line, being clear of the obstacle free zone.</p>				

6.12.5 The location of a runway-holding position established in accordance with paragraph 6.12.2 must be such that a holding aircraft or vehicle will not infringe the obstacle free zone, approach surface, take-off climb surface or ILS/MLS critical/ sensitive area or interfere with the operation of radio navigation aids.

<sup>63</sup> Guidance for the positioning of runway-holding positions is given ICAO Aerodrome Design Manual (Doc 9157), Part 2.



### 6.13 Aprons

6.13.1 Aprons must be provided where necessary to permit the loading and unloading of passengers, cargo or mail as well as the servicing of aircraft without interfering with the aerodrome traffic.

#### Strength of aprons

6.13.2 Each part of an apron must be capable of withstanding the traffic of the aircraft it is intended to serve, due consideration being given to the fact that some portions of the apron will be subjected to a higher density of traffic and, as a result of slow moving or stationary aircraft, to higher stresses than a runway.

#### Slopes on aprons

6.13.3 On an aircraft stand the maximum slope must not exceed 1 per cent.

#### Clearance distances on aircraft stands

6.13.4 An aircraft stand must provide the following minimum clearances between an aircraft entering or exiting the stand<sup>64</sup> and any adjacent building, aircraft on another stand and other objects:

<u>Code letter</u>	<u>Clearance</u>
A	3 m
B	3 m
C	4.5 m
D	7.5 m
E	7.5 m
F	7.5 m

When special circumstances so warrant, these clearances may be reduced at a nose-in aircraft stand, where the code letter is D, E or F:

- (a) between the terminal, including any fixed passenger bridge, and the nose of an aircraft; and
- (b) over any portion of the stand provided with azimuth guidance by a visual docking guidance system.

### 6.14 Isolated aircraft parking position

6.14.1 An isolated aircraft parking position must be designated or the aerodrome control tower must be advised of an area or areas suitable for the parking of an aircraft which is known or believed to be the subject of unlawful interference, or which for other reasons needs isolation from normal aerodrome activities.

---

<sup>64</sup> On aprons, consideration also has to be given to the provision of service roads and to manoeuvring and storage area for ground equipment (See the ICAO Aerodrome Design Manual (Doc 9157), Part 2, for guidance on storage of ground equipment).

## 7 Obstacle Restriction and Removal

### 7.1 Obstacle limitation surfaces<sup>65</sup>

#### Outer horizontal surface<sup>66</sup>

#### Conical surface

7.1.1 Description – Conical surface. A surface sloping upwards and outwards from the periphery of the inner horizontal surface.

7.1.2 Characteristics – The limits of the conical surface must comprise:

- (a) a lower edge coincident with the periphery of the inner horizontal surface; and
- (b) an upper edge located at a specified height above the inner horizontal surface.

7.1.3 The slope of the conical surface must be measured in a vertical plane perpendicular to the periphery of the inner horizontal surface.

#### Inner horizontal surface

7.1.4 Description – Inner horizontal surface. A surface located in a horizontal plane above an aerodrome and its environs.

7.1.5 Characteristics – The radius or outer limits of the inner horizontal surface<sup>67</sup> must be measured from a reference point or points established for such purpose.

7.1.6 The height of the inner horizontal surface must be measured above an elevation datum<sup>68</sup> established for such purpose.

#### Approach surface

7.1.7 Description – Approach surface. An inclined plane or combination of planes preceding the threshold.

7.1.8 Characteristics – The limits of the approach surface must comprise:

- (a) an inner edge of specified length, horizontal and perpendicular to the extended centre line of the runway and located at a specified distance before the threshold;
- (b) two sides originating at the ends of the inner edge and diverging uniformly at a specified rate from the extended centre line of the runway; and
- (c) an outer edge parallel to the inner edge.

---

<sup>65</sup> See Figure 7-1

<sup>66</sup> Guidance on the need to provide an outer horizontal surface and its characteristics is contained in the ICAO Airport Services Manual (Doc 9137), Part 6.

<sup>67</sup> The shape of the inner horizontal surface need not necessarily be circular. Guidance on determining the extent of the inner horizontal surface is contained in the ICAO Airport Services Manual (Doc 9137), Part 6.

<sup>68</sup> Guidance on determining the elevation datum is contained in the ICAO Airport Services Manual (Doc 9137), Part 6.

- 7.1.9 The surfaces, mentioned in paragraph 7.1.8, must be varied when lateral offset, offset or curved approaches are utilised, specifically, two sides originating at the ends of the inner edge and diverging uniformly at a specified rate from the extended centre line of the lateral offset, offset or curved ground track.
- 7.1.10 The elevation of the inner edge must be equal to the elevation of the mid-point of the threshold.
- 7.1.11 The slope(s) of the approach surface must be measured in the vertical plane containing the centre line of the runway and must continue containing the centre line of any lateral offset or curved ground track.

Inner approach surface

- 7.1.12 Description – Inner approach surface. A rectangular portion of the approach surface immediately preceding the threshold.
- 7.1.13 Characteristics – The limits of the inner approach surface must comprise:
- (a) an inner edge coincident with the location of the inner edge of the approach surface but of its own specified length;
  - (b) two sides originating at the ends of the inner edge and extending parallel to the vertical plane containing the centre line of the runway; and
  - (c) an outer edge parallel to the inner edge.

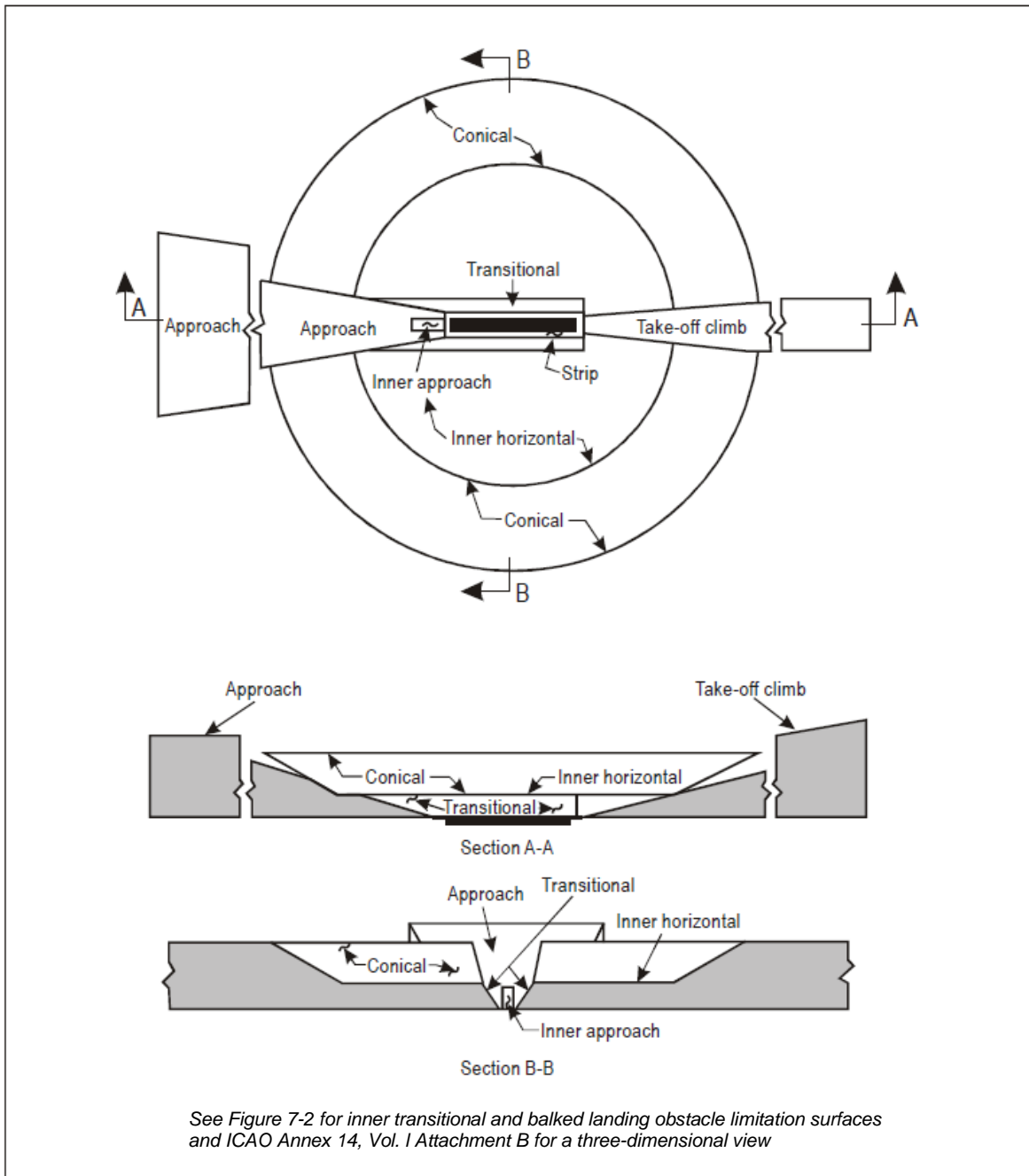

Figure 7-1. Obstacle limitation surfaces

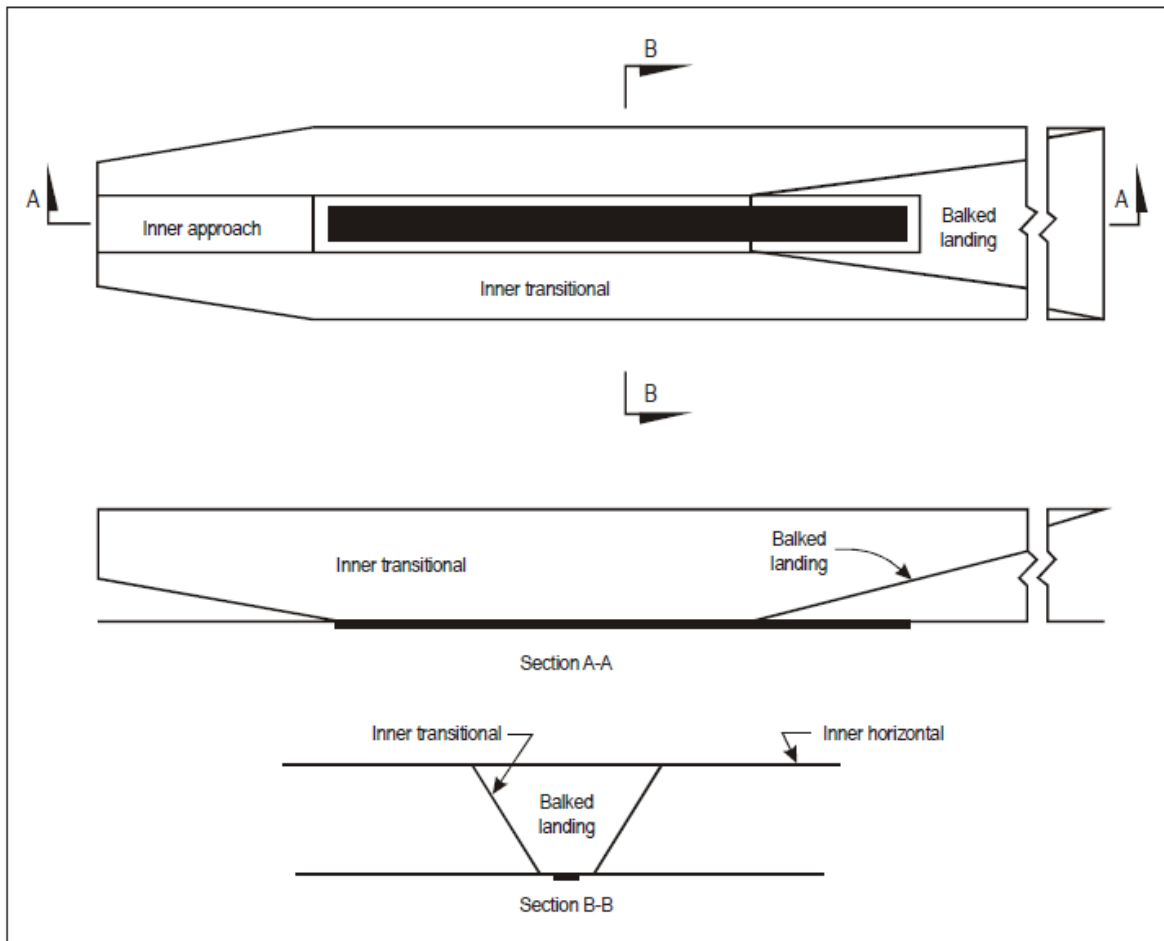

Figure 7-2. Inner approach, inner transitional and balked landing obstacle limitation surfaces

### Transitional surface

7.1.14 Description – Transitional surface. A complex surface along the side of the strip and part of the side of the approach surface, that slopes upwards and outwards to the inner horizontal surface.

7.1.15 Characteristics – The limits of the transitional surface must comprise:

- (a) a lower edge beginning at the intersection of the side of the approach surface with the inner horizontal surface and extending down the side of the approach surface to the inner edge of the approach surface and from there along the length of the strip parallel to the runway centre line; and
- (b) an upper edge located in the plane in the inner horizontal surface.

7.1.16 The elevation of a point on the lower edge must be:

- (a) along the side of the approach surface – equal to the elevation of the approach surface at that point; and
- (b) along the strip – equal to the elevation of the nearest point on the centre line of the runway or its extension<sup>69</sup>.

7.1.17 The slope of the transitional surface must be measured in a vertical plane at right angles to the centre line of the runway.

#### Inner transitional surface

7.1.18 Description – Inner transitional surface<sup>70</sup>. A surface similar to the transitional surface but closer to the runway.

7.1.19 Characteristics – The limits of an inner transitional surface must comprise:

- (a) a lower edge beginning at the end of the inner approach surface and extending down the side of the inner approach surface to the inner edge of that surface, from there along the strip parallel to the runway centre line to the inner edge of the balked landing surface and from there up the side of the balked landing surface to the point where the side intersects the inner horizontal surface; and
- (b) an upper edge located in the plane of the inner horizontal surface.

7.1.20 The elevation of a point on the lower edge must be:

- (a) along the side of the inner approach surface and balked landing surface – equal to the elevation of the particular surface at that point; and
- (b) along the strip – equal to the elevation of the nearest point on the centre line of the runway or its extension<sup>71</sup>.

7.1.21 The slope of inner transitional surface must be measured in a vertical plane at right angles to the centre line of the runway.

#### Balked landing surface

7.1.22 Description – Balked landing surface. An inclined plane located at a specified distance after the threshold, extending between the inner transitional surface.

---

<sup>69</sup> As a result of b) the transitional surface along the strip will be curved if the runway profile is curved, or a plane if the runway profile is a straight line. The intersection of the transitional surface with the inner horizontal surface will also be a curved or a straight line depending on the runway profile.

<sup>70</sup> It is intended that the inner transitional surface be the controlling obstacle limitation surface for navigation aids, aircraft and other vehicles that must be near the runway and which is not be penetrated except for frangible objects. The transitional surface described in paragraph 7.1.14 is intended to remain as the controlling obstacle limitation surface for buildings, etc.

<sup>71</sup> As a result of b) the inner transitional surface along the strip will be curved if the runway profile is curved or a plane if the runway profile is a straight line. The intersection of the inner transitional surface with the inner horizontal surface will also be a curved or a straight line depending on the runway profile.

7.1.23 Characteristics – The limits of the balked landing surface must comprise:

- (a) an inner edge horizontal and perpendicular to the centre line of the runway and located at a specified distance after the threshold;
- (b) two sides originating at the ends of the inner edge and diverging uniformly at a specified rate from the vertical plane containing the centre line of the runway; and
- (c) an outer edge parallel to the inner edge and located in the plane of the inner horizontal surface.

7.1.24 The elevation of the inner edge must be equal to the elevation of the runway centre line at the location of the inner edge.

7.1.25 The slope of the balked landing surface must be measured in the vertical plane containing the centre line of the runway.

Take-off climb surface

7.1.26 Description – Take-off climb surface. An inclined plane or other specified surface beyond the end of a runway or clearway.

7.1.27 Characteristics – The limits of the take-off climb surface must comprise:

- (a) an inner edge horizontal and perpendicular to the centre line of the runway and located either at a specified distance beyond the end of the runway or at the end of the clearway when such is provided and its length exceeds the specified distance;
- (b) two sides originating at the ends of the inner edge, diverging uniformly at a specified rate from the take-off track to a specified final width and continuing thereafter at that width for the remainder of the length of the take-off climb surface; and
- (c) an outer edge horizontal and perpendicular to the specified take-off track.

7.1.28 The elevation of the inner edge must be equal to the highest point on the extended runway centre line between the end of the runway and the inner edge, except that when a clearway is provided the elevation must be equal to the highest point on the ground on the centre line of the clearway.

7.1.29 In the case of a straight take-off flight path, the slope of the take-off climb surface must be measured in the vertical plane containing the centre line of the runway.

7.1.30 In the case of a take-off flight path involving a turn, the take-off climb surface must be a complex surface containing the horizontal normals to its centre line, and the slope of the centre line must be the same as that for a straight take-off flight path.

## 7.2 Obstacle limitation requirements<sup>72</sup>

### Non-instrument runways

- 7.2.1 The following obstacle limitation surfaces must be established for a non-instrument runway.
- conical surface;
  - inner horizontal surface;
  - approach surface; and
  - transitional surfaces.
- 7.2.2 The heights and slopes of the surfaces must not be greater than and their other dimensions not less than those specified in Table 7-1.
- 7.2.3 New objects or extensions of existing objects must not be permitted above an approach or transitional surface except when the new object or extension would be shielded<sup>73</sup> by an existing immovable object.
- 7.2.4 New objects or extensions of existing objects must not be permitted above the conical surface or inner horizontal surface except when the object would be shielded by an existing immovable object, or after aeronautical study it is determined that the object would not adversely affect the safety or significantly affect the regularity of operations of aeroplanes.

---

<sup>72</sup> The requirements for obstacle limitation surfaces are specified on the basis of the intended use of a runway, i.e. take-off or landing and type of approach, and are intended to be applied when such use is made of the runway. In case where operations are conducted to or from both directions of a runway; then the function of certain surfaces may be nullified because of more stringent requirements of another lower surface.

<sup>73</sup> Circumstances in which the shielding principle may reasonably be applied are described in the ICAO Airport Services Manual (Doc 9137), Part 6.



Table 7-1 – Dimensions and slopes of obstacle limitation surfaces – Approach runways

## APPROACH RUNWAYS

Surface and dimensions <sup>a</sup>	RUNWAY CLASSIFICATION									
	Non-instrument				Non-precision approach			Precision approach category		
	Code number				Code number			I	II or III	
	1	2	3	4	1,2	3	4	1,2	3,4	3,4
(1)	(2)	(3)	(4)	(5)	(6)	(7)	(8)	(9)	(10)	(11)
CONICAL										
Slope	5%	5%	5%	5%	5%	5%	5%	5%	5%	5%
Height	35 m	55 m	75 m	100 m	60 m	75 m	100 m	60 m	100 m	100 m
INNER HORIZONTAL										
Height	45 m	45 m	45 m	45 m	45 m	45 m	45 m	45 m	45 m	45 m
Radius	2 000 m	2 500 m	4 000 m	4 000 m	3 500 m	4 000 m	4 000 m	3 500 m	4 000 m	4 000 m
INNER APPROACH										
Width	-	-	-	-	-	-	-	90 m	120 m <sup>e</sup>	120 m <sup>e</sup>
Distance from threshold	-	-	-	-	-	-	-	60 m	60 m	60 m
Length	-	-	-	-	-	-	-	900 m	900 m	900 m
Slope	-	-	-	-	-	-	-	2.5%	2%	2%
APPROACH										
Length of inner edge	60 m	80 m	150 m	150 m	140 m	280 m	280 m	140 m	280 m	280 m
Distance from threshold	30 m	60 m	60 m	60 m	60 m	60 m	60 m	60 m	60 m	60 m
Divergence (each side)	10%	10%	10%	10%	15%	15%	15%	15%	15%	15%
First section										
Length	1 600 m	2 500 m	3 000 m	3 000 m	2 500 m	3 000 m	3 000 m	3 000 m	3 000 m	3 000 m
Slope	5%	4%	3.33%	2.5%	3.33%	2%	2%	2.5%	2%	2%

(continue next page)

Table 7-1 – Dimensions and slopes of obstacle limitation surfaces – Approach runways

## APPROACH RUNWAYS (continued)

Surface and dimensions <sup>a</sup>	RUNWAY CLASSIFICATION									
	Non-instrument				Non-precision approach			Precision approach category		
	Code number				Code number			I	II or III	
	1	2	3	4	1,2	3	4	1,2	3,4	3,4
(1)	(2)	(3)	(4)	(5)	(6)	(7)	(8)	(9)	(10)	(11)
APPROACH										
Second section										
Length	-	-	-	-	-	3 600 m <sup>b</sup>	3 600 m <sup>b</sup>	12 000 m	3 600 m <sup>b</sup>	3 600 m <sup>b</sup>
Slope	-	-	-	-	-	2.5%	2.5%	3%	2.5%	2.5%
Horizontal section										
Length	-	-	-	-	-	8 400 m <sup>b</sup>	8 400 m <sup>b</sup>	-	8 400 m <sup>b</sup>	8 400 m <sup>b</sup>
Total length	-	-	-	-	-	15 000 m	15 000 m	15 000 m	15 000 m	15 000 m
TRANSITIONAL										
Slope	20%	20%	14.3%	14.3%	20%	14.3%	14.3%	14.3%	14.3%	14.3%
INNER TRANSITIONAL										
Slope	-	-	-	-	-	-	-	40%	33.3%	33.3%
BALKED LANDING SURFACE										
Length of inner edge	-	-	-	-	-	-	-	90 m	120 m <sup>e</sup>	120 m <sup>e</sup>
Distance from threshold	-	-	-	-	-	-	-	<sup>c</sup>	1 800 m <sup>d</sup>	1 800 m <sup>d</sup>
Divergence (each side)	-	-	-	-	-	-	-	10%	10%	10%
Slope	-	-	-	-	-	-	-	4%	3.33%	3.33%

<sup>a</sup> All dimensions are measured horizontally unless specified otherwise.

<sup>b</sup> Variable length (See paragraph 7.2.7 or 7.2.11).

<sup>c</sup> Distance to the end of strip.

<sup>d</sup> Or end of runway whichever is less.

<sup>e</sup> Where the code letter is F (Table 4-1), the width is increased to 140m except for those aerodromes that accommodate a code letter F aeroplanes equipped with digital avionics that provide steering commands to maintain an established track during the go-around manoeuvre. See Circulars 301, 345 and Chapter 4 of the ICAO PANS-Aerodromes, part 1 (Doc 9981) for further information.

Non-precision approach runways

7.2.5 The following obstacle limitation surfaces must be established for a non-precision approach runway:

- conical surface;
- inner horizontal surface;
- approach surface; and
- transitional surfaces.

7.2.6 The heights and slopes of the surfaces must not be greater than, and their other dimensions not less than, those specified in Table 7-1, except in the case of the horizontal section of the approach surface (See paragraph 7.2.7).

7.2.7 The approach surface must be horizontal beyond the point at which the 2.5 per cent slope intersects:

- (a) a horizontal plane 150m above the threshold elevation; or
- (b) the horizontal plane passing through the top of any object that governs the obstacle clearance altitude/height (OCA/H);

whichever is the higher.

7.2.8 New objects or extensions of existing objects must not be permitted above an approach surface within 3,000 m of the inner edge or above a transitional surface except when the new object or extension would be shielded<sup>74</sup> by an existing immovable object.

Precision approach runways<sup>75</sup>

7.2.9 The following obstacle limitation surfaces must be established for a precision approach runway category I, II and III:

- conical surface;
- inner horizontal surface;
- approach surface and inner approach surface;
- transitional surfaces;
- inner transitional surfaces; and
- balked landing surface.

7.2.10 The heights and slopes of the surfaces must not be greater than, and their other dimensions not less than, those specified in Table 7-1, except in the case of the horizontal section of the approach surface (See paragraph 7.2.11).

---

<sup>74</sup> Circumstances in which the shielding principle may reasonably be applied are described in the ICAO Airport Services Manual (Doc 9137), Part 6.

<sup>75</sup> Guidance on obstacle limitation surfaces for precision approach runways is given in the ICAO Airport Services Manual (Doc 9137), Part 6. See paragraph 12.5 for information regarding siting of equipment and installations on operational areas.

7.2.11 The approach surface must be horizontal beyond the point at which the 2.5 per cent slope intersects:

- (a) a horizontal plane 150 m above the threshold elevation; or
- (b) the horizontal plane passing through the top of any object that governs the obstacle clearance limit;

whichever is the higher.

7.2.12 Fixed objects must not be permitted above the inner approach surface, the inner transitional surface or the balked landing surface, except for frangible objects which because of their function must be located on the strip. Mobile objects must not be permitted above these surfaces during the use of the runway for landing.

7.2.13 New objects or extensions of existing objects must not be permitted above an approach surface or a transitional surface except when the new object or extension would be shielded<sup>76</sup> by an existing immovable object.

#### Runways meant for take-off

7.2.14 A take-off climb surface must be established for a runway meant for take-off.

7.2.15 The dimension of the surface must be not less than the dimensions specified in Table 7-2, except that a lesser length may be adopted or the take-off climb surface where such lesser length would be consistent with procedural measures adopted to govern the outward flight of aeroplanes.

7.2.16 New objects or extensions of existing objects must not be permitted above a take-off climb surface except when the new object or extension would be shielded<sup>76</sup> by an existing immovable object.

---

<sup>76</sup> Circumstances in which the shielding principle may reasonably be applied are described in the ICAO Airport Services Manual (Doc 9137), Part 6.

Table 7-2 – Dimensions and slopes of obstacle limitation surfaces

## RUNWAYS MEANT FOR TAKE-OFF

Surface and dimensions <sup>a</sup>	Code number		
	1	2	3 or 4
(1)	(2)	(3)	(4)
TAKE-OFF CLIMB			
Length of inner edge	60 m	80 m	180 m
Distance from runway end <sup>b</sup>	30 m	60 m	60 m
Divergence (each side)	10%	10%	12.5%
Final width	380 m	580 m	1 200 m 1 800 m <sup>c</sup>
Length	1 600 m	2 500 m	15 000 m
Slope	5%	4%	2%
<sup>a</sup> All dimensions are measured horizontally unless specified otherwise.			
<sup>b</sup> The take-off climb surface starts at the end of the clearway if the clearway length exceeds the specified distance.			
<sup>c</sup> 1,800 m when intended track includes changes of heading greater than 15° for operations conducted in IMC, VMC by night.			

## 8 Visual Aids for Navigation

### 8.1 Indicators and signalling devices

#### 8.1.1 Wind direction indicator

##### *Application*

8.1.1.1 An aerodrome must be equipped with at least one wind direction indicator.

##### *Location*

8.1.1.2 A wind direction indicator must be located so as to be visible from aircraft in flight or on the movement area and in such a way as to be free from the effects of air disturbances caused by nearby objects.

##### *Characteristics*

8.1.1.3 Provision must be made for illuminating all wind direction indicators at an aerodrome intended for use at night.

#### 8.1.2 Landing direction indicator

##### *Location*

8.1.2.1 Where provided, a landing direction indicator must be located in a conspicuous place on the aerodrome.

##### *Characteristics*

8.1.2.2 The shape and minimum dimensions of a landing "T" must be as shown in Figure 8-1. The colour of the landing "T" must be either white or orange, the choice being dependent on the colour that contrasts best with the background against which the indicator will be viewed. Where required for use at night, the landing "T" must either be illuminated or outlined by white lights.

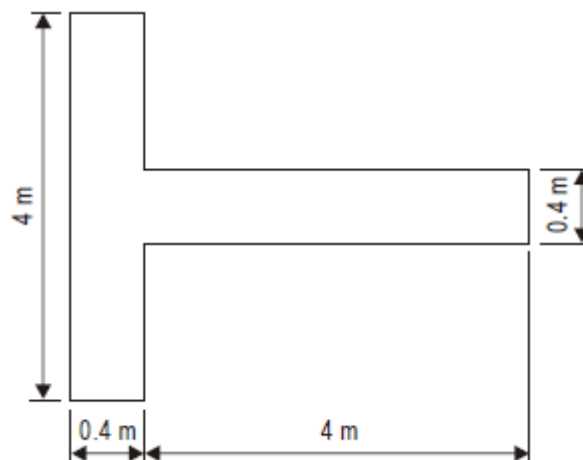

Figure 8-1. Landing direction indicator

### 8.1.3 Signalling lamp

#### *Application*

8.1.3.1 A signalling lamp must be provided at a controlled aerodrome in the aerodrome control tower.

### 8.1.4 Signal panels and signal area

The inclusion of detailed specifications for a signal area is not intended to imply that one has to be provided<sup>77</sup>.

#### *Characteristics of signal area*

8.1.4.1 The signal area must be an even horizontal surface at least 9 m square.

## **8.2 Markings**

### 8.2.1 General

#### *Interruption of runway markings*

8.2.1.1 At an intersection of two (or more) runways the markings of the more important runway, except for the runway side stripe marking, must be displayed and the markings of the other runway(s) must be interrupted. The runway side stripe marking of the more important runway may be either continued across the intersection or interrupted.

8.2.1.2 At an intersection of a runway and taxiway the markings of the runway must be displayed, and the markings of the taxiway interrupted, except that runway side stripe markings may be interrupted.

#### *Colour and conspicuity*

8.2.1.3 Runway markings must be white<sup>78</sup>.

8.2.1.4 Taxiway markings, runway turn pad markings and aircraft stand markings must be yellow.

8.2.1.5 Apron safety lines must be of a conspicuous colour which must contrast with that used for aircraft stand markings.

### 8.2.2 Runway designation marking

#### *Application*

8.2.2.1 A runway designation marking must be provided at the thresholds of a paved runway.

---

<sup>77</sup> ICAO Annex 14 Vol. I, Attachment A, Section 16 provides guidance on the need to provide ground signals. ICAO Annex 2, Appendix 1 specifies the shape, colour and use of visual ground signals. The ICAO Aerodrome Design Manual (Doc 9157), Part 4 provides guidance on their design.

<sup>78</sup> It has been found that, on runway surfaces of light colour, the conspicuity of white markings can be improved by outlining them in black. It is preferable that the risk of uneven friction characteristics on markings be reduced in so far as practicable by the use of a suitable kind of paint. Markings may consist of solid areas or a series of longitudinal stripes providing an effect equivalent to the solid areas.

Location

8.2.2.2 A runway designation marking must be located at a threshold<sup>79</sup> as shown in Figure 8-2 as appropriate.

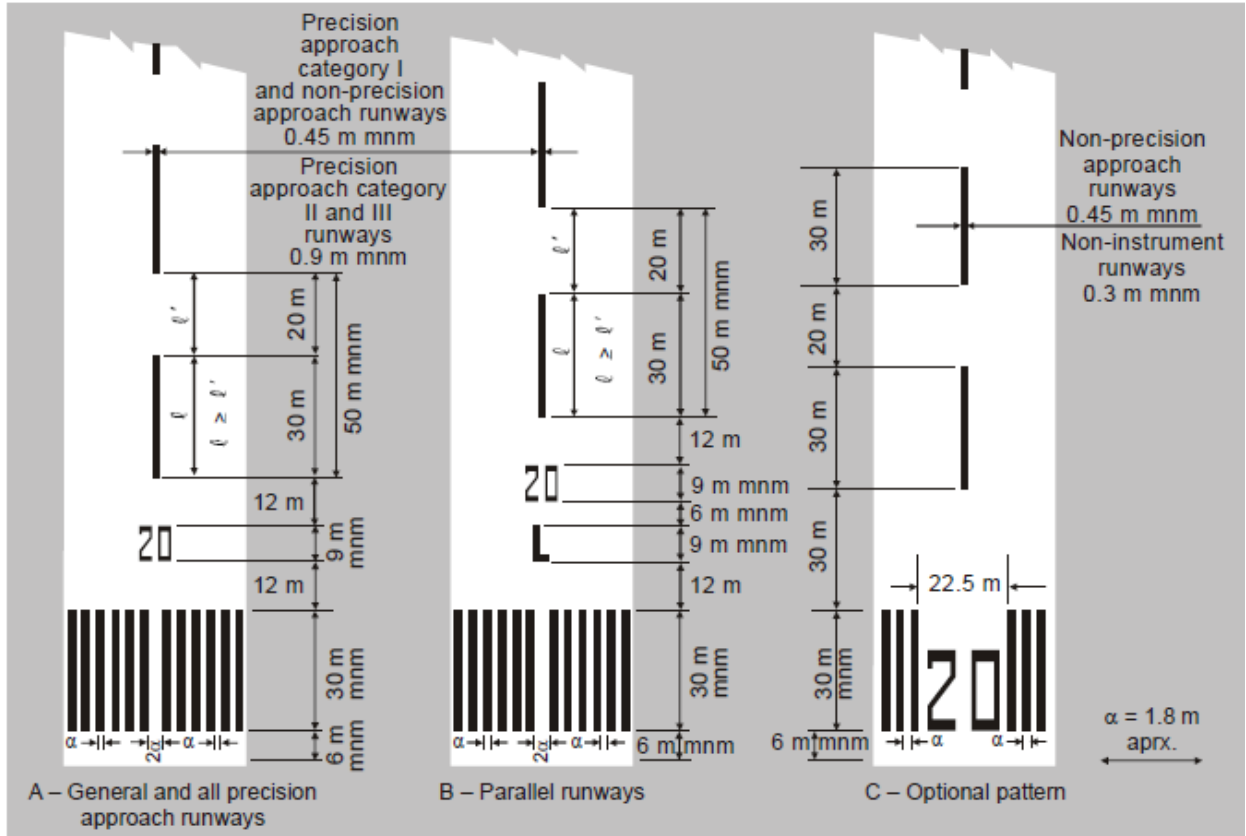

Figure 8-2. Runway designation, centre line and threshold markings

Characteristics

8.2.2.3 A runway designation marking must consist of a two-digit number and on parallel runways must be supplemented with a letter. On a single runway, dual parallel runways and triple parallel runways the two-digit number must be the whole number nearest the one-tenth of the magnetic North when viewed from the direction of approach. On four or more parallel runways, one set of adjacent runways must be numbered to the nearest one-tenth magnetic azimuth and the other set of adjacent runways numbered to the next nearest one-tenth of the magnetic azimuth. When the above rule would give a single digit number, it must be preceded by a zero.

<sup>79</sup> If the runway threshold is displaced from the extremity of the runway, a sign showing the designation of the runway may be provided for aeroplanes taking off.



8.2.2.4 In the case of parallel runways, each runway designation number must be supplemented by a letter as follows, in the order shown from left to right when viewed from the direction of approach:

- for two parallel runways: “L” “R”;
- for three parallel runways: “L” “C” “R”;
- for four parallel runways: “L” “R” “L” “R”;
- for five parallel runways: “L” “C” “R” “L” “R” or “L” “R” “L” “C” “R”; and
- for six parallel runways: “L” “C” “R” “L” “C” “R”.

8.2.2.5 The numbers and letters must be in the form and proportion shown in Figure 8-3. The dimensions must be not less than those shown in Figure 8-3, but where the numbers are incorporated in the threshold marking, larger dimensions must be used in order to fill adequately the gap between the stripes of the threshold marking.

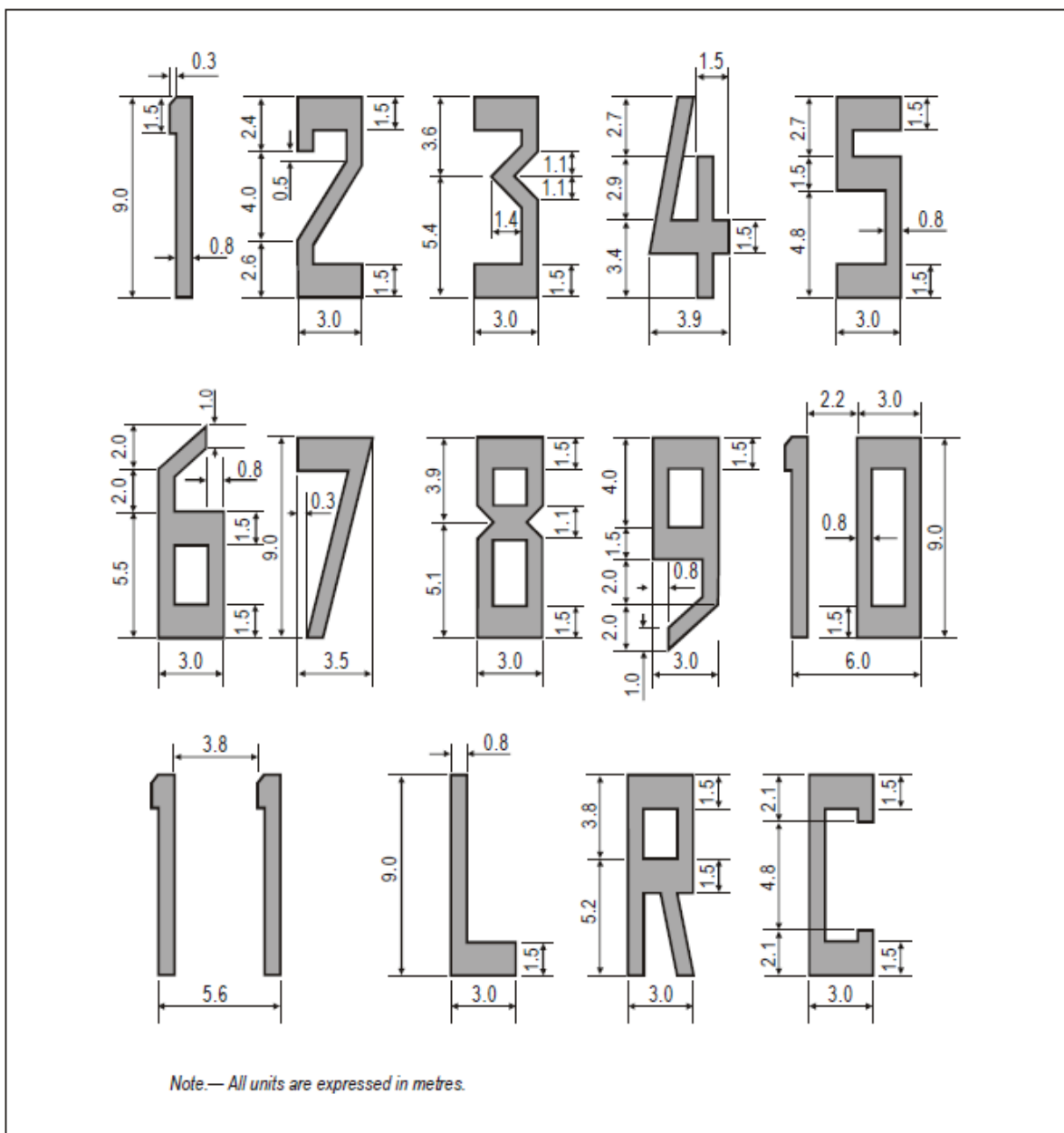

Figure 8-3. Form and proportions of numbers and letters for runway designation markings

### 8.2.3 Runway centre line marking

#### *Application*

8.2.3.1 A runway centre line marking must be provided on a paved runway.

#### *Location*

8.2.3.2 A runway centre line marking must be located along the centre line of the runway between the runway designation markings as shown in Figure 8-2, except when interrupted in compliance with paragraph 8.2.1.1.

#### *Characteristics*

8.2.3.3 A runway centre line marking must consist of a line of uniformly spaced stripes and gaps. The length of a stripe plus a gap must be not less than 50 m or more than 75 m. The length of each stripe must be at least equal to the length of the gap or 30 m, whichever is greater.

8.2.3.4 The width of the stripes must be not less than:

- 0.90 m on precision approach category II and III runways;
- 0.45 m on non-precision approach runways where the code number is 3 or 4, and precision approach category I runways; and
- 0.30 m on non-precision approach runways where the code number is 1 or 2, and on non-instrument runways.

### 8.2.4 Threshold marking

#### *Application*

8.2.4.1 A threshold marking must be provided at the threshold of a paved instrument runway, and of a paved non-instrument runway where the code number is 3 or 4 and the runway is intended for use by international commercial air transport.

#### *Location*

8.2.4.2 The stripes of the threshold marking must commence 6m from the threshold.

*Characteristics*

8.2.4.3 A runway threshold marking must consist of a pattern of longitudinal stripes of uniform dimensions disposed symmetrically about the centre line of a runway as shown in Figure 8-2 (A) and (B) for a runway width of 45m. The number of stripes must be in accordance with the runway width as follows:

<u>Runway width</u>	<u>Number of stripes</u>
18 m	4
23 m	6
30 m	8
45 m	12
60 m	16

except that on non-precision approach and non-instrument runways 45m or greater in width, they may be as shown in Figure 8-2 (C).

8.2.4.4 The stripes must extend laterally to within 3m of the edge of a runway or to a distance of 27m on either side of a runway centre line, whichever results in the smaller lateral distance. Where a runway designation marking is placed within a threshold marking there must be a minimum of three stripes on each side of the centre line of the runway. Where a runway designation marking is placed above a threshold marking, the stripes must be continued across the runway. The stripes must be at least 30m long and approximately 1.80m wide with spacings of approximately 1.80m between them except that, where the stripes are continued across a runway, a double spacing must be used to separate the two stripes nearest the centre line of the runway, and in the case where the designation marking is included within the threshold marking this spacing must be 22.5m.

*Transverse stripe*

8.2.4.5 A transverse stripe must be not less than 1.80 m wide.

*Arrows*

8.2.4.6 Where a runway threshold is permanently displaced, arrows conforming to Figure 8-4 (B) must be provided on the portion of the runway before the displaced threshold.

8.2.4.7 When a runway threshold<sup>80</sup> is temporarily displaced from the normal position, it must be marked as shown in Figure 8-4 (A) or 8-4 (B) and all markings prior to the displaced threshold must be obscured except the runway centre line marking, which must be converted to arrows.

---

<sup>80</sup> In the case where a threshold is temporarily displaced for only a short period of time, it has been found satisfactory to use markers in the form and colour of a displaced threshold marking rather than attempting to paint this marking on the runway. When the runway before a displaced threshold is unfit for the surface movement of aircraft, closed markings, as described in paragraph 10.1.3, are required to be provided.

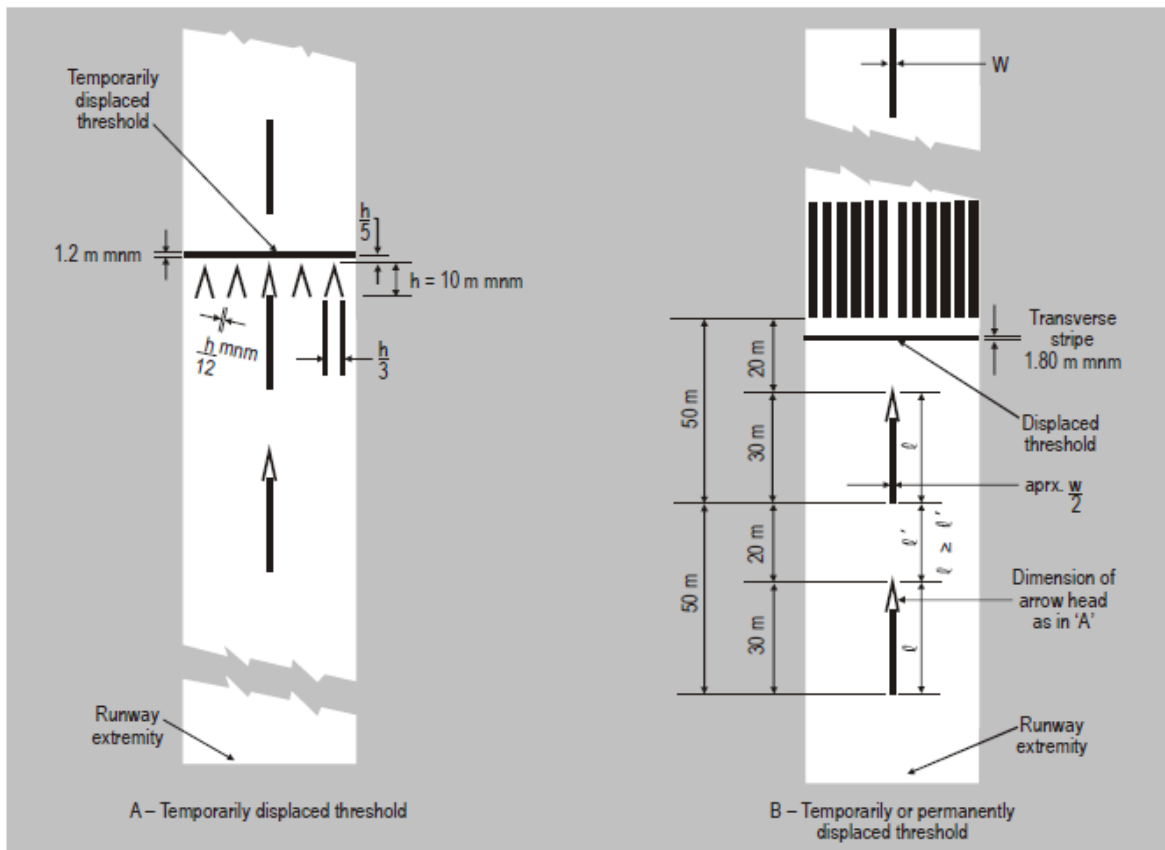

Figure 8-4. Displaced threshold markings

### 8.2.5 Aiming point marking

#### *Application*

8.2.5.1 An aiming point marking must be provided at each approach end of a paved instrument runway where the code number is 2, 3 or 4.

#### *Location*

8.2.5.2 The aiming point marking must commence no closer to the threshold than the distance indicated in the appropriate column of Table 8-1, except that, on a runway equipped with a visual approach slope indicator system, the beginning of the marking must be coincident with the visual approach slope origin.

8.2.5.3 An aiming point marking must consist of two conspicuous stripes. The dimensions of the stripes and the lateral spacing between their inner sides must be in accordance with the provisions of the appropriate column of Table 8-1. Where a touchdown zone marking is provided, the lateral spacing between the markings must be the same as that of the touchdown zone marking.

Table 8-1 – Location and dimensions of aiming point marking

Location and dimensions	Landing distance available			
	Less than 800 m	800 m up to but not including 1 200 m	1,200 m up to but not including 2 400 m	2,400 m and above
(1)	(2)	(3)	(4)	(5)
Distance from threshold to beginning of marking	150 m	250 m	300 m	400 m
Length of stripe <sup>a</sup>	30-45 m	30-45 m	45-60 m	45-60 m
Width of stripe	4 m	6 m	6-10 m <sup>b</sup>	6-10m <sup>b</sup>
Lateral spacing between inner sides of stripes	6 m <sup>c</sup>	9 m <sup>c</sup>	18-22.5 m	18-22.5 m
<sup>a</sup> The greater dimensions of the specified ranges are intended to be used where increased conspicuity is required.				
<sup>b</sup> The lateral spacing may be varied within these limits to minimise the contamination of the marking by rubber deposits.				
<sup>c</sup> These figures were deduced by reference to the outer main gear wheel space which is element 2 of the aerodrome reference code at Chapter 4, Table 4-1.				

## 8.2.6 Touchdown zone marking

### *Application*

8.2.6.1 A touchdown zone marking must be provided in the touchdown zone of a paved precision approach runway where the code number is 2, 3 or 4.

### *Location and characteristics*

8.2.6.2 A touchdown zone marking must consist of pairs of rectangular markings symmetrically disposed about the runway centre line with the number of such pairs related to the landing distance available and, where the marking is to be displayed at both the approach directions of a runway, the distance between the thresholds, as follows:

<u>Landing distance available or the distance between thresholds</u>	<u>Pair(s) of markings</u>
Less than 900 m	1
900m up to but not including 1,200 m	2
1 200m up to but not including 1,500 m	3
1 500m up to but not including 2,400 m	4
2,400m or more	6

8.2.6.3 A touchdown zone marking must conform to either of the two patterns shown in Figure 8-5. For the pattern shown in Figure 8-5 (A), the markings must be not less than 22.5 m long and 3 m wide. For the pattern shown in Figure 8-5 (B), each stripe of each marking must be not less than 22.5 m long and 1.8 m wide with a spacing of 1.5 m between adjacent stripes. The lateral spacing between the inner sides of the rectangles must be equal to that of the aiming point marking where provided. Where an aiming point marking is not provided, the lateral spacing between the inner sides of the rectangles must correspond to the lateral spacing specified for the aiming point marking in Table 8-1 (columns 2, 3, 4 or 5, as appropriate). The pairs of markings must be provided at longitudinal spacings of 150 m beginning from the threshold except that pairs of touchdown zone markings coincident with or located within 50 m of an aiming point marking must be deleted from the pattern.

## **8.2.7 Runway side stripe marking**

### *Application*

8.2.7.1 A runway side stripe marking must be provided between the thresholds of a paved runway where there is a lack of contrast between the runway edges and the shoulders or the surrounding terrain.

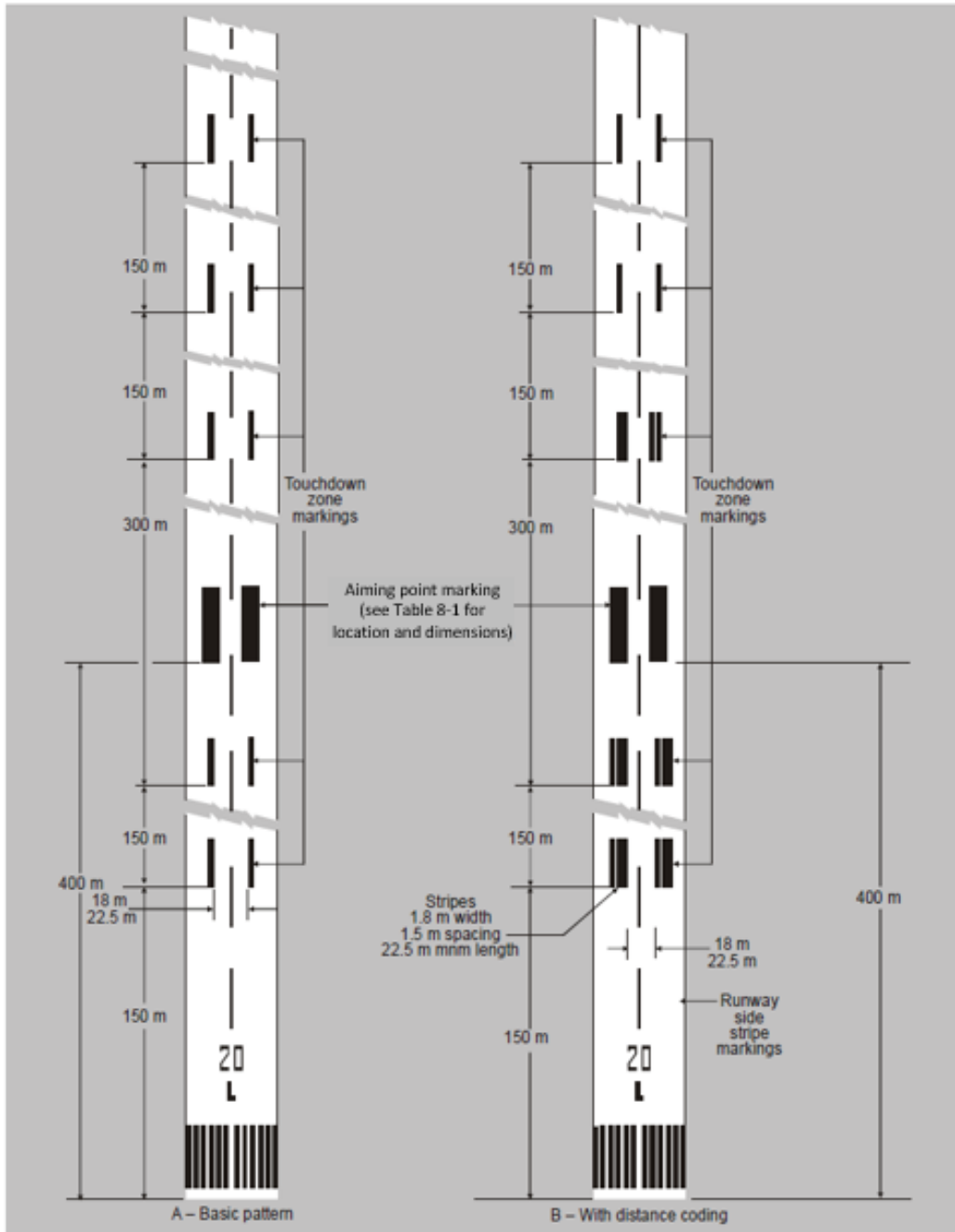

Figure 8-5. Aiming point and touchdown zone markings  
(illustrated for a runway with a length of 2400m or more)

## 8.2.8 Taxiway centre line marking

### *Application*

- 8.2.8.1 Taxiway centre line marking must be provided on a paved taxiway and apron where the code number is 3 or 4 in such a way as to provide continuous guidance between the runway centre line and aircraft stands.

8.2.8.2 Taxiway centre line marking must be provided on a paved runway when the runway is part of a standard taxi-route and:

- (a) there is no runway centre line marking; or
- (b) where the taxiway centre line is not coincident with the runway centre line.

8.2.8.3 Where provided, enhanced taxiway centre line marking must be installed at each taxiway/runway intersection.

*Location*

8.2.8.4 Where provided, an enhanced taxiway centre line marking must extend from the runway-holding position Pattern A (as defined in Figure 8-6, Taxiway markings) to a distance of at least 47m in the direction of travel away from the runway. See Figure 8-7(a).

8.2.8.5 Where provided, if the enhanced taxiway centre line marking intersects another runway-holding position marking, such as for a precision approach category II or III runway, that is located within 47m of the first runway-holding position marking, the enhanced taxiway centre line marking must be interrupted 0.9m prior to and after the intersected runway-holding position marking. The enhanced taxiway centre line marking must continue beyond the intersected runway-holding position marking for at least three dashed line segments or 47m from start to finish, whichever is greater. See Figure 8-7(b).

8.2.8.6 Where provided, if the enhanced taxiway centre line marking continues through a taxiway/taxiway intersection that is located within 47m of the runway-holding position marking, the enhanced taxiway centre line marking must be interrupted 1.5m prior to and after the point where the intersected taxiway centre line crosses the enhanced taxiway centre line. The enhanced taxiway centre line marking must continue beyond the taxiway/taxiway intersection for at least three dashed line segments or 47m from start to finish, whichever is greater. See Figure 8-7(c).

8.2.8.7 Where two taxiway centre lines converge at or before the runway-holding position marking, the inner dashed line must not be less than 3m in length. See Figure 8-7(d).

8.2.8.8 Where there are two opposing runway-holding position markings and the distance between the markings is less than 94m, the enhanced taxiway centre line markings must extend over this entire distance. The enhanced taxiway centre line markings must not extend beyond either runway-holding position marking. See Figure 8-7(e).

*Characteristics*

8.2.8.9 A taxiway centre line marking must be at least 15cm in width and continuous in length except where it intersects with a runway-holding position marking or an intermediate holding position marking as shown in Figure 8-6.

8.2.8.10 Enhanced taxiway centre line marking must be as shown in Figure 8-7.



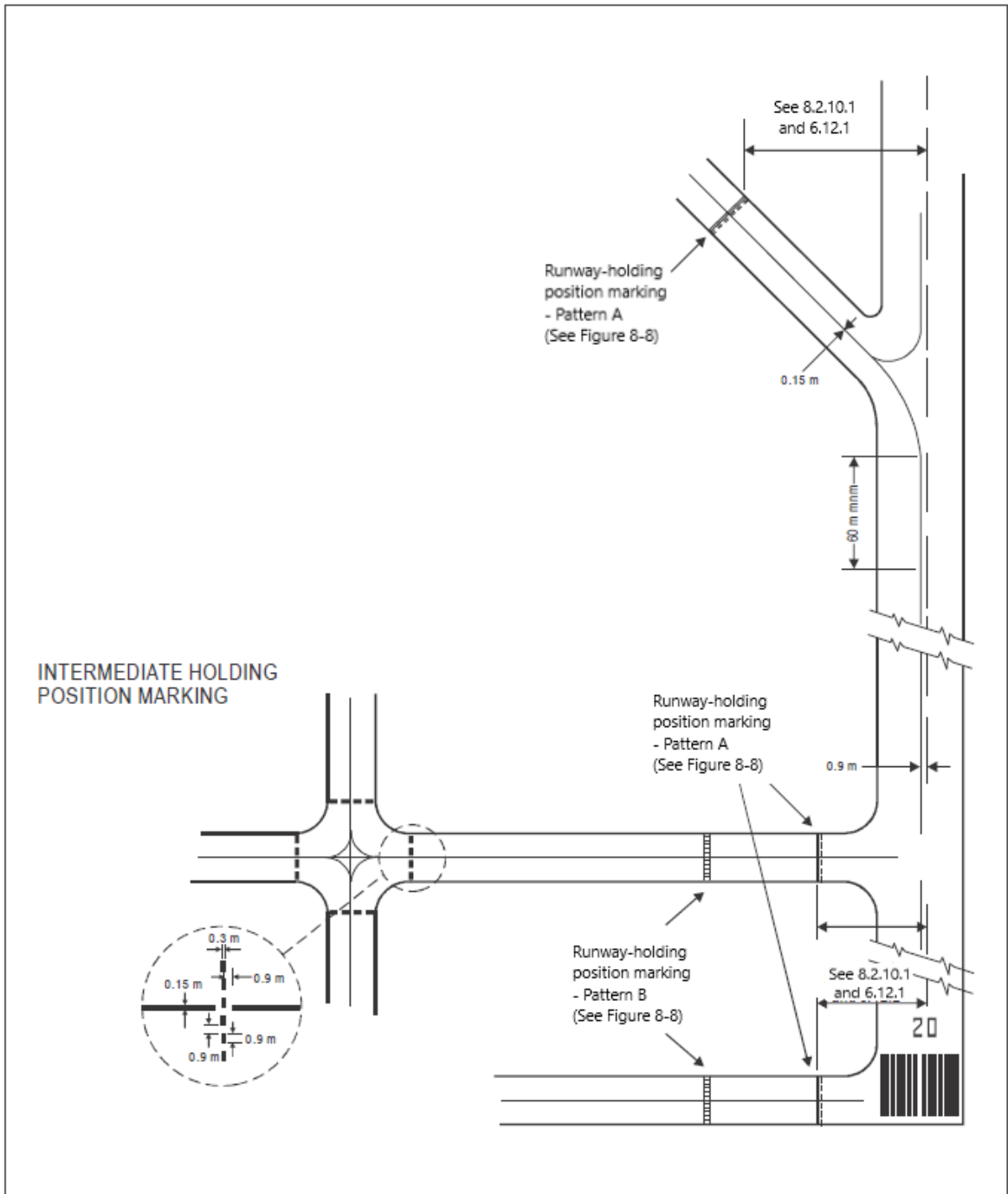

Figure 8-6. Taxiway markings  
(Shown with basic runway markings)

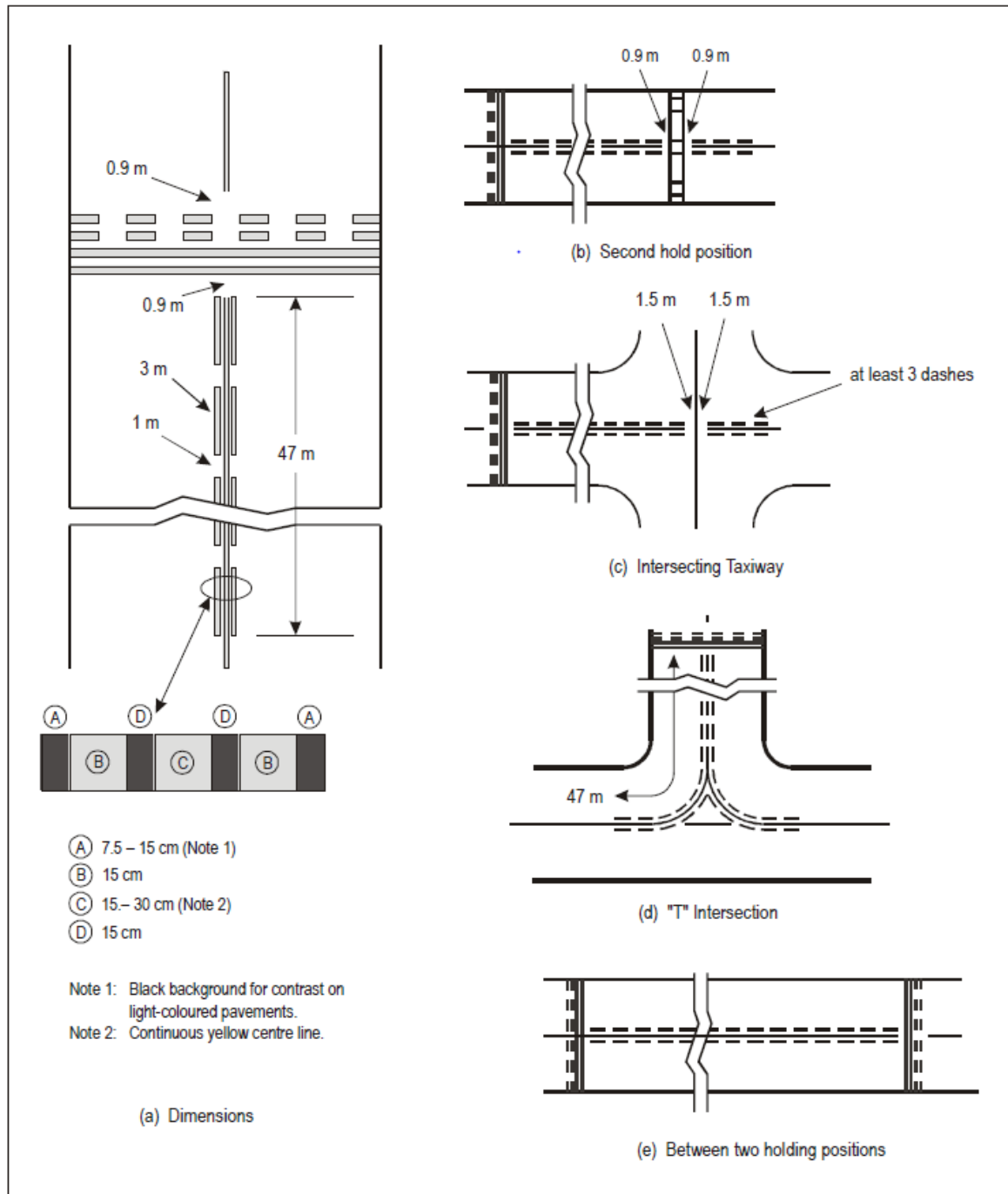

Figure 8-7. Enhanced taxiway centre line marking

## 8.2.9 Runway turn pad marking

### Application

- 8.2.9.1 Where a runway turn pad is provided, a runway turn pad marking must be provided for continuous guidance to enable an aeroplane to complete a 180-degree turn and align with the runway centre line.

*Characteristics*

8.2.9.2 A runway turn pad marking must be at least 15cm in width and continuous in length.

**8.2.10 Runway-holding position marking**

*Application and location*

8.2.10.1 A runway-holding position marking<sup>81</sup> must be displayed along a runway-holding position.

*Characteristics*

8.2.10.2 At an intersection of a taxiway and a non-instrument, non-precision approach or take-off runway, the runway-holding position marking must be as shown in Figure 8-6, pattern A.

8.2.10.3 Where a single runway-holding position is provided at an intersection of a taxiway and a precision approach category I, II or III runway, the runway-holding position marking must be as shown in Figure 8-6, pattern A. Where two or three runway-holding positions are provided at such an intersection, the runway-holding position marking closer (closest) to the runway must be as shown in Figure 8-6, pattern A and the markings farther from the runway must be as shown in Figure 8-6, pattern B.

8.2.10.4 The runway-holding position marking displayed at a runway-holding position established in accordance with paragraph 6.12.2 must be as shown in Figure 8-6, pattern A.

8.2.10.5 Until 26 November 2026, the dimensions of runway-holding position markings must be as shown in Figure 8-8, pattern A1 (or A2) or pattern B1 (or B2), as appropriate.

8.2.10.6 From 26 November 2026, the dimensions of runway-holding position marking must be as shown in Figure 8-8, pattern A2 or pattern B2, as appropriate.

---

<sup>81</sup> See 8.4.2 concerning the provision of signs at runway-holding positions.

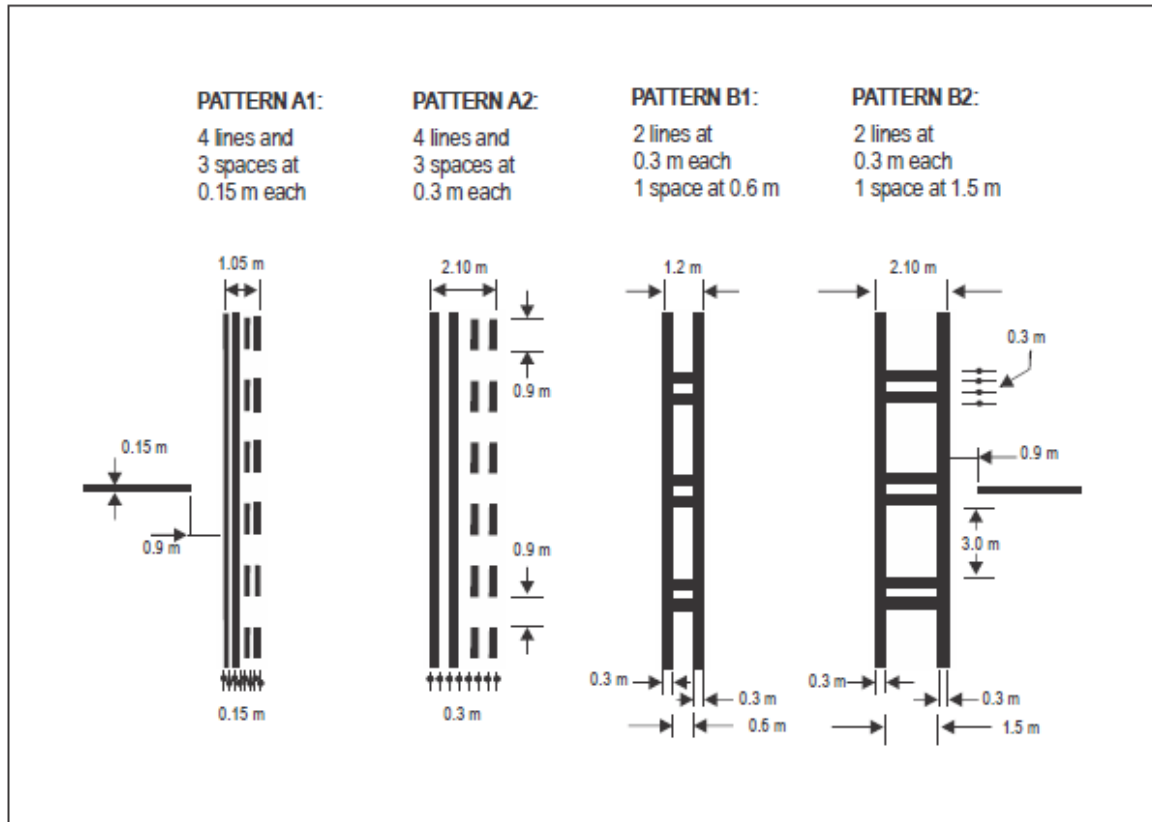

Figure 8-8. Runway-holding position markings  
(Patterns A1 and B1 are no longer valid after 2026)

8.2.10.7 The runway-holding position marking displayed at a runway/runway intersection must be perpendicular to the centre line of the runway forming part of the standard taxi-route. The pattern of the marking must be as shown in Figure 8-8, pattern A2.

### 8.2.11 Intermediate holding position marking

#### *Application and location*

8.2.11.1 Where an intermediate holding position marking is displayed at an intersection of two paved taxiways, it must be located across the taxiway at sufficient distance from the near edge of the intersecting taxiway to ensure safe clearance between taxiing aircraft. It must be coincident with a stop bar or intermediate holding position lights, where provided.

#### *Characteristics*

8.2.11.2 An intermediate holding position marking must consist of a single broken line as shown in Figure 8-6.

### 8.2.12 VOR aerodrome check-point marking

#### Application

8.2.12.1 When a VOR aerodrome check-point is established, it must be indicated by a VOR aerodrome check-point<sup>82</sup> marking and sign.

#### Location

8.2.12.2 A VOR aerodrome check-point marking must be centred on the spot at which an aircraft is to be parked to receive the correct VOR signal.

#### Characteristics

8.2.12.3 A VOR aerodrome check-point marking must consist of a circle 6m in diameter and have a line width of 15cm (See Figure 8-9 (A)).

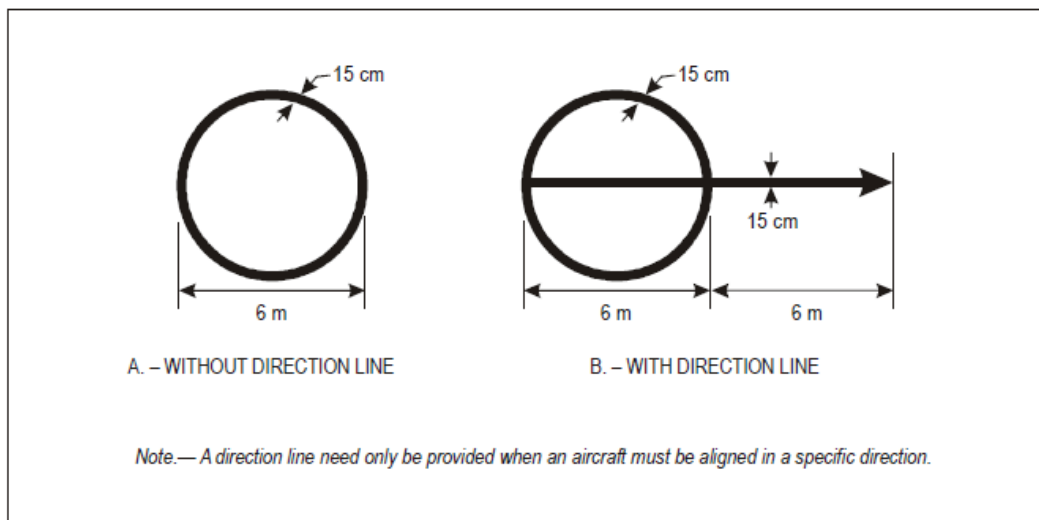

Figure 8-9. VOR aerodrome checkpoint marking

### 8.2.13 Apron safety lines

#### Location

8.2.13.1 Apron safety lines<sup>83</sup> must be located so as to define the areas intended for use by ground vehicles and other aircraft servicing equipment, etc., to provide safe separation from aircraft.

<sup>82</sup> See 8.4.4 for VOR aerodrome check-point sign. Guidance on the selection of sites for VOR aerodrome check-points is given in ICAO Annex 10, Volume I, Attachment E.

<sup>83</sup> Guidance on apron safety lines is contained in the ICAO Aerodrome Design Manual (Doc 9157), Part 4.

### **8.2.14 Road-holding position marking**

#### *Application*

8.2.14.1 A road-holding position marking must be provided at all road entrances to a runway.

#### *Location*

8.2.14.2 The road-holding position marking must be located across the road at the holding position.

#### *Characteristics*

8.2.14.3 The road-holding position marking must be in accordance with the road traffic regulations.

### **8.2.15 Mandatory instruction marking**

#### *Application*

8.2.15.1 Where it is impracticable to install a mandatory instruction sign<sup>84</sup> in accordance with paragraph 8.4.2.1, a mandatory instruction marking must be provided on the surface of the pavement.

#### *Location*

8.2.15.2 The mandatory instruction marking on taxiways, where the code letter is A, B, C, or D, must be located across the taxiway equally placed about the taxiway centerline and on the holding side of the runway-holding position marking as shown in Figure 8-10 (A). The distance between the nearest edge of the marking and the runway-holding position marking or the taxiway centre line marking must be not less than 1m.

---

<sup>84</sup> Guidance on mandatory instruction marking is given in the ICAO Aerodrome Design Manual (Doc 9157), Part 4.

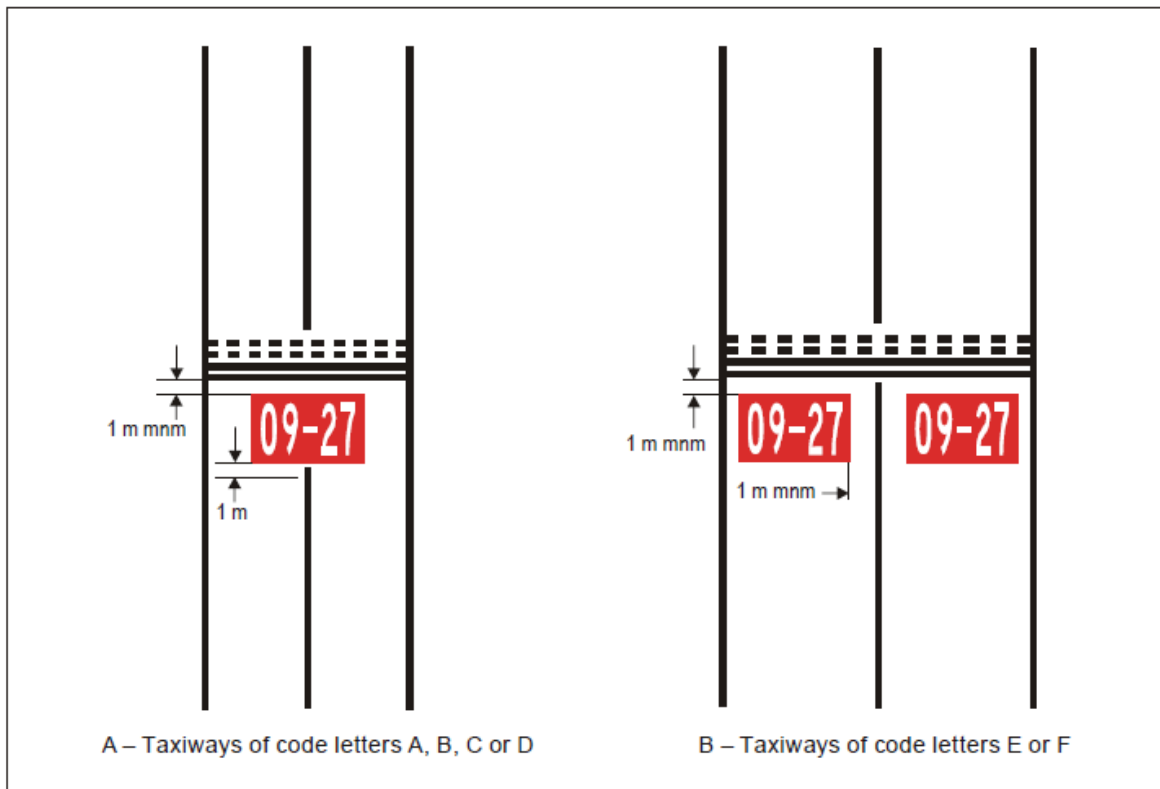

Figure 8-10. Mandatory instruction marking

8.2.15.3 The mandatory instruction marking on taxiways, where the code letter E or F, must be located on both sides of the taxiway centre line marking and on the holding side of the runway-holding position marking as shown in Figure 8-10 (B). The distance between the nearest edge of the marking and the runway-holding position marking or the taxiway centre line marking must be not less than 1m.

#### *Characteristics*

8.2.15.4 A mandatory instruction marking must consist of an inscription in white on a red background. Except for a NO ENTRY marking, the inscription must provide information identical to that of the associated mandatory instruction sign.

8.2.15.5 A NO ENTRY marking must consist of an inscription in white reading “NO ENTRY” on a red background.

8.2.15.6 Where there is insufficient contrast between the marking and the pavement surface, the mandatory instruction marking must include an appropriate border, preferably white or black.

### **8.2.16 Information marking**

#### *Application*

8.2.16.1 Where an information sign would normally be installed and is impractical to install, as determined by the aerodrome operator, an information marking<sup>85</sup> must be displayed on the surface of the pavement.

<sup>85</sup> Guidance on information marking is contained in the ICAO Aerodrome Design Manual (Doc 9157), Part 4.

### *Characteristics*

8.2.16.2 An information marking must consist of:

- (a) an inscription in yellow upon a black background, when it replaces or supplements a location sign; and
- (b) an inscription in black upon a yellow background, when it replaces or supplements a direction or destination sign.

8.2.16.3 Where there is insufficient contrast between the marking background and the pavement surface, the marking must include:

- (a) a black border where the inscriptions are in black; and
- (b) a yellow border where the inscriptions are in yellow.

## **8.3 Lights**

### **8.3.1 General**

#### *Lights which may endanger the safety of aircraft*

8.3.1.1 A non-aeronautical ground light near an aerodrome which might endanger the safety of aircraft must be extinguished, screened or otherwise modified so as to eliminate the source of danger.

#### *Elevated approach lights*

8.3.1.2 Elevated approach lights and their supporting structures must be frangible except that, in that portion of the approach lighting system beyond 300m from the threshold:

- (a) where the height of a supporting structure exceeds 12m, the frangibility requirement must apply to the top 12m only; and
- (b) where a supporting structure is surrounded by non-frangible objects, only that part of the structure that extends above the surrounding objects must be frangible.

8.3.1.3 When an approach light fixture or supporting structure is not in itself sufficiently conspicuous, it must be suitably marked.

#### *Elevated lights*

8.3.1.4 Elevated runway, stopway and taxiway lights must be frangible. Their height must be sufficiently low to preserve clearance for propellers and for the engine pods of jet aircraft.



*Surface lights*

8.3.1.5 Light fixtures inset in the surface of runways, stopways, taxiways and aprons must be so designed and fitted as to withstand being run over by the wheels of an aircraft without damage either to the aircraft or to the lights themselves.

*Light intensity and control*<sup>86</sup>

8.3.1.6 The intensity of runway lighting must be adequate for the minimum conditions of visibility and ambient light in which use of the runway is intended, and compatible with that of the nearest section of the approach lighting system<sup>87</sup> when provided.

8.3.1.7 Where a high-intensity lighting system is provided, a suitable intensity control must be incorporated to allow for adjustment of the light intensity to meet the prevailing conditions. Separate intensity controls or other suitable methods must be provided to ensure that the following systems, when installed, can be operated at compatible intensities:

- approach lighting system;
- runway edge lights;
- runway threshold lights;
- runway end lights;
- runway centre line lights;
- runway touchdown zone lights; and
- taxiway centre line lights.

8.3.1.8 On the perimeter of and within the ellipse defining the main beam in Appendix 3, Figures A3-1 to A3-10, the maximum light intensity value must not be greater than three times the minimum light intensity value measured in accordance with Appendix 3, collective notes for Figures A3-1 to A3-11 and A3-26, Note 2.

8.3.1.9 On the perimeter of and within the rectangle defining the main beam in Appendix 3, Figures A3-12 to A3-20, the maximum light intensity value must not be greater than three times the minimum light intensity value measured in accordance with Appendix 3, collective notes for Figures A3-12 to A3-21, Note 2.

---

<sup>86</sup> In dusk or poor visibility conditions by day, lighting can be more effective than marking. For lights to be effective in such conditions or in poor visibility by night, they must be of adequate intensity. To obtain the required intensity, it will usually be necessary to make the light directional, in which case the arcs over which the light shows will have to be adequate and so orientated as to meet the operational requirements. The runway lighting system will have to be considered as a whole, to ensure that the relative light intensities are suitably matched to the same end. (See ICAO Annex 14 Vol. I, Attachment A, Section 15, and the ICAO Aerodrome Design Manual (Doc 9157), Part 4).

<sup>87</sup> While the lights of an approach lighting system may be of higher intensity than the runway lighting, it is good practice to avoid abrupt changes in intensity as these could give a pilot a false impression that the visibility is changing during approach.

### **8.3.2 Aeronautical beacons**

#### *Application*

8.3.2.1 Where operationally necessary an aerodrome beacon or an identification beacon must be provided at each aerodrome intended for use at night.

8.3.2.2 The operational requirement must be determined having regard to the requirements of the air traffic using the aerodrome, the conspicuity of the aerodrome features in relation to its surroundings and the installation of other visual and non-visual aids useful in locating the aerodrome.

#### Aerodrome beacon

8.3.2.3 An aerodrome beacon must be provided at an aerodrome intended for use at night if one or more of the following conditions exist:

- (a) aircraft navigate predominantly by visual means;
- (b) reduced visibilities are frequent; or
- (c) it is difficult to locate the aerodrome from the air due to surrounding lights or terrain.

#### *Location*

8.3.2.4 The aerodrome beacon must be located on or adjacent to the aerodrome in an area of low ambient background lighting.

#### *Characteristics*

8.3.2.5 The aerodrome beacon must show either coloured flashes alternating with white flashes, or white flashes only. The frequency of total flashes must be from 20 to 30 per minute. Where used, the coloured flashes emitted by beacons at land aerodromes must be green and coloured flashes emitted by beacons at water aerodromes must be yellow. In the case of a combined water and land aerodrome, coloured flashes, if used, must have the colour characteristics of whichever section of the aerodrome is designated as the principal facility.

8.3.2.6 The light from the beacon must show at all angles of azimuth. The vertical light distribution must extend upwards from an elevation of not more than 1° to an elevation that is sufficient to provide guidance at the maximum elevation at which the beacon is intended to be used and the effective intensity of the flash must be not less than 2 000 cd<sup>88</sup>.

#### Identification beacon

#### *Application*

8.3.2.7 An identification beacon must be provided at an aerodrome which is intended for use at night and cannot be easily identified from the air by other means.

---

<sup>88</sup> At locations where a high ambient background lighting level cannot be avoided, the effective intensity of the flash may be required to be increased by a factor up to a value of 10.

*Location*

8.3.2.8 The identification beacon must be located on the aerodrome in an area of low ambient background lighting.

*Characteristics*

8.3.2.9 An identification beacon at a land aerodrome must show at all angles of azimuth. The vertical light distribution must extend upwards from an elevation of not more than 1° to an elevation that is sufficient to provide guidance at the maximum elevation at which the beacon is intended to be used and the effective intensity of the flash must be not less than 2 000 cd<sup>88</sup>.

8.3.2.10 An identification beacon must show flashing-green at a land aerodrome and flashing-yellow at a water aerodrome.

8.3.2.11 The identification characters must be transmitted in the International Morse Code.

### **8.3.3 Approach lighting systems**

#### 8.3.3.1 Application

##### B — Non-precision approach runway

Where physically practicable, a simple approach lighting system as specified in paragraphs 8.3.3.2 to 8.3.3.6 must be provided to serve a non-precision approach runway, except when the runway is used only in conditions of good visibility or sufficient guidance is provided by other visual aids.<sup>89</sup>

##### C — Precision approach runway category I

Where physically practicable, a precision approach category I lighting system as specified in paragraphs 8.3.3.7 to 8.3.4.17 must be provided to serve a precision approach runway category I.

##### D — Precision approach runway categories II and III

A precision approach category II and III lighting system as specified in paragraphs 8.3.3.18 to 8.3.3.34 must be provided to serve a precision approach runway category II or III.

#### Simple approach lighting system

*Location*

8.3.3.2 A simple approach lighting system must consist of a row of lights on the extended centre line of the runway extending, whenever possible, over a distance of not less than 420m from the threshold with a row of lights forming a crossbar 18m or 30m in length at a distance of 300m from the threshold.

---

<sup>89</sup> It is advisable to give consideration to the installation of a precision approach category I lighting system or to the addition of a runway lead-in lighting system.

- 8.3.3.3 The lights forming the crossbar must be as nearly as practicable in a horizontal straight line at right angles to, and bisected by, the line of the centre line lights. The lights of the crossbar must be spaced<sup>90</sup> so as to produce a linear effect, except that, when a crossbar of 30m is used, gaps may be left on each side of the centre line. These gaps must not exceed 6m.
- 8.3.3.4 The lights forming the centre line must be placed at longitudinal intervals of 60m, except that, when it is desired to improve the guidance, an interval of 30m may be used. The innermost light must be located either 60m or 30m from the threshold, depending on the longitudinal interval selected for the centre line lights.
- 8.3.3.5 The system must lie as nearly as practicable in the horizontal plane passing through the threshold, provided that:
- (a) no object other than an ILS or MLS azimuth antenna must protrude through the plane of the approach lights within a distance of 60m from the centre line of the system; and
  - (b) no light other than a light located within the central part of a crossbar or a centre line barrette (not their extremities) must be screened from an approaching aircraft.

Any ILS or MLS azimuth antenna protruding through the plane of the lights must be treated as an obstacle and marked and lighted accordingly.

#### *Characteristics*

- 8.3.3.6 The lights of a simple approach lighting system must be fixed lights and the colour of the lights must be such as to ensure that the system is readily distinguishable from other aeronautical ground lights, and from extraneous lighting if present. Each centre line light must consist of either:
- (a) a single source; or
  - (b) a barrette at least 3m in length<sup>91</sup>.

#### Precision approach category I lighting system

##### *Location*

- 8.3.3.7 A precision approach category I lighting system<sup>92</sup> must consist of a row of lights on the extended centre line of the runway extending, wherever possible, over a distance of 900m from the runway threshold with a row of lights forming a crossbar 30m in length at a distance of 300m from the runway threshold.

---

<sup>90</sup> Spacings for the crossbar lights between 1m and 4m are in use. Gaps on each side of the centre line may improve directional guidance when approaches are made with a lateral error and facilitate the movement of rescue and fire fighting vehicles. See ICAO Annex 14 Vol. I, Attachment A, Section 11 for guidance on installation tolerances.

<sup>91</sup> When the barrette as in b) is composed of lights approximating to point sources, a spacing of 1.5m between adjacent lights in the barrette has been found satisfactory. It may be advisable to use barrettes 4m in length if it is anticipated that the simple approach lighting system will be developed into a precision approach lighting system. At locations where identification of the simple approach lighting system is difficult at night due to surrounding lights, sequence flashing lights installed in the outer portion of the system may resolve this problem.

<sup>92</sup> The installation of an approach lighting system of less than 900m in length may result in operational limitations on the use of the runway. See ICAO Annex 14 Vol. I, Attachment A, Section 11.

- 8.3.3.8 The lights forming the crossbar must be as nearly as practicable in a horizontal straight line at right angles to, and bisected by, the line of the centre line lights. The lights of the crossbar must be spaced<sup>93</sup> so as to produce a linear effect, except that gaps may be left on each side of the centre line. These gaps must not exceed 6m.
- 8.3.3.9 The lights forming the centre line must be placed at longitudinal intervals of 30m with the innermost light located 30m from the threshold.
- 8.3.3.10 The system must lie as nearly as practicable in the horizontal plane passing through the threshold, provided that:
- (a) no object other than an ILS or MLS azimuth antenna must protrude through the plane of the approach lights within a distance of 60m from the centre line of the system; and
  - (b) no light other than a light located within the central part of a crossbar or a centre line barrette (not their extremities) must be screened from an approaching aircraft.

Any ILS or MLS azimuth antenna protruding through the plane of the lights must be treated as an obstacle and marked and lighted accordingly.

#### *Characteristics*

- 8.3.3.11 The centre line and crossbar lights of a precision approach category I lighting system must be fixed lights showing variable white. Each centre line light position must consist of either:
- (a) a single light source in the innermost 300m of the centre line, two light sources in the central 300m of the centre line and three light sources in the outer 300m of the centre line to provide distance information; or
  - (b) a barrette.
- 8.3.3.12 Where the serviceability level of the approach lights specified as a maintenance objective in 13.4.7 can be demonstrated, each centre line light position may consist of either:
- (a) a single light source; or
  - (b) a barrette.
- 8.3.3.13 The barrettes must be at least 4m in length. When barrettes are composed of lights approximating to point sources, the lights must be uniformly spaced at intervals of not more than 1.5m.
- 8.3.3.14 If the centre line consists of barrettes which are supplemented by flashing lights, each flashing light must be flashed twice a second in sequence, beginning with the

---

<sup>93</sup> Spacings for the crossbar lights between 1m and 4m are in use. Gaps on each side of the centre line may improve directional guidance when approaches are made with a lateral error and facilitate the movement of rescue and fire fighting vehicles. See ICAO Annex 14 Vol. I, Attachment A, Section 11 for guidance on installation tolerances.

outermost light and progressing toward the threshold to the innermost light of the system. The design of the electrical circuit must be such that these lights can be operated independently of the other lights of the approach lighting system.

- 8.3.3.15 If the centre line consists of lights as described in paragraph 8.3.3.11 a) or 8.3.3.12 a), additional crossbars of lights to the crossbar provided at 300m from the threshold must be provided at 150m, 450m, 600m and 750m from the threshold. The lights forming each crossbar must be as nearly as practicable in a horizontal straight line at right angles to, and bisected by, the line of the centre line lights. The lights must be spaced so as to produce a linear effect, except that gaps may be left on each side of the centre line. These gaps must not exceed 6m<sup>94</sup>.
- 8.3.3.16 Where the additional crossbars described in paragraph 8.3.3.15 are incorporated in the system, the outer ends of the crossbars must lie on two straight lines that either are parallel to the line of the centre line lights or converge to meet the runway centre line 300m from threshold.
- 8.3.3.17 The lights<sup>95</sup> must be in accordance with the specifications in Appendix 3, Figure A3-1.

#### Precision approach category II and III lighting system

##### *Location*

- 8.3.3.18 The approach lighting system must consist of a row of lights on the extended centre line of the runway, extending, wherever possible, over a distance of 900m<sup>96</sup> from the runway threshold. In addition, the system must have two side rows of lights, extending 270m from the threshold, and two crossbars, one at 150m and one at 300m from the threshold, all as shown in Figure 8-11. Where the serviceability level of the approach lights specified as maintenance objectives in paragraph 13.4.4 can be demonstrated, the system may have two side rows of lights, extending 240m from the threshold, and two crossbars, one at 150m and one at 300m from the threshold, all as shown in Figure 8-12.
- 8.3.3.19 The lights forming the centre line must be placed at longitudinal intervals of 30 m with the innermost lights located 30m from the threshold.
- 8.3.3.20 The lights forming the side rows must be placed on each side of the centre line, at a longitudinal spacing equal to that of the centre line lights and with the first light located 30m from the threshold. Where the serviceability level of the approach lights specified as maintenance objectives in paragraph 13.4.4 can be demonstrated, lights forming the side rows may be placed on each side of the centre line, at a longitudinal spacing of 60 m with the first light located 60m from the threshold. The lateral spacing (or gauge) between the innermost lights of the side rows must be not less than 18m nor more than 22.5m, and preferably 18m, but in any event must be equal to that of the touchdown zone lights.

---

<sup>94</sup> See ICAO Annex 14 Vol. I, Attachment A, Section 11 for detailed configuration.

<sup>95</sup> The flight path envelopes used in the design of these lights are given in ICAO Annex 14 Vol. I, Attachment A, Figure A-6.

<sup>96</sup> The length of 900 m is based on providing guidance for operations under category I, II and III conditions. Reduced lengths may support category II and III operations but may impose limitations on category I operations. See ICAO Annex 14 Vol. I, Attachment A, Section 11.

8.3.3.21 The crossbar provided at 150m from the threshold must fill in the gaps between the centre line and side row lights.

8.3.3.22 The crossbar provided at 300m from the threshold must extend on both sides of the centre line lights to a distance of 15m from the centre line.

8.3.3.23 If the centre line beyond a distance of 300m from the threshold consists of lights as described in paragraph 8.3.4.27 b) or 8.3.4.28 b), additional crossbars of lights must be provided at 450m, 600m and 750m from the threshold.

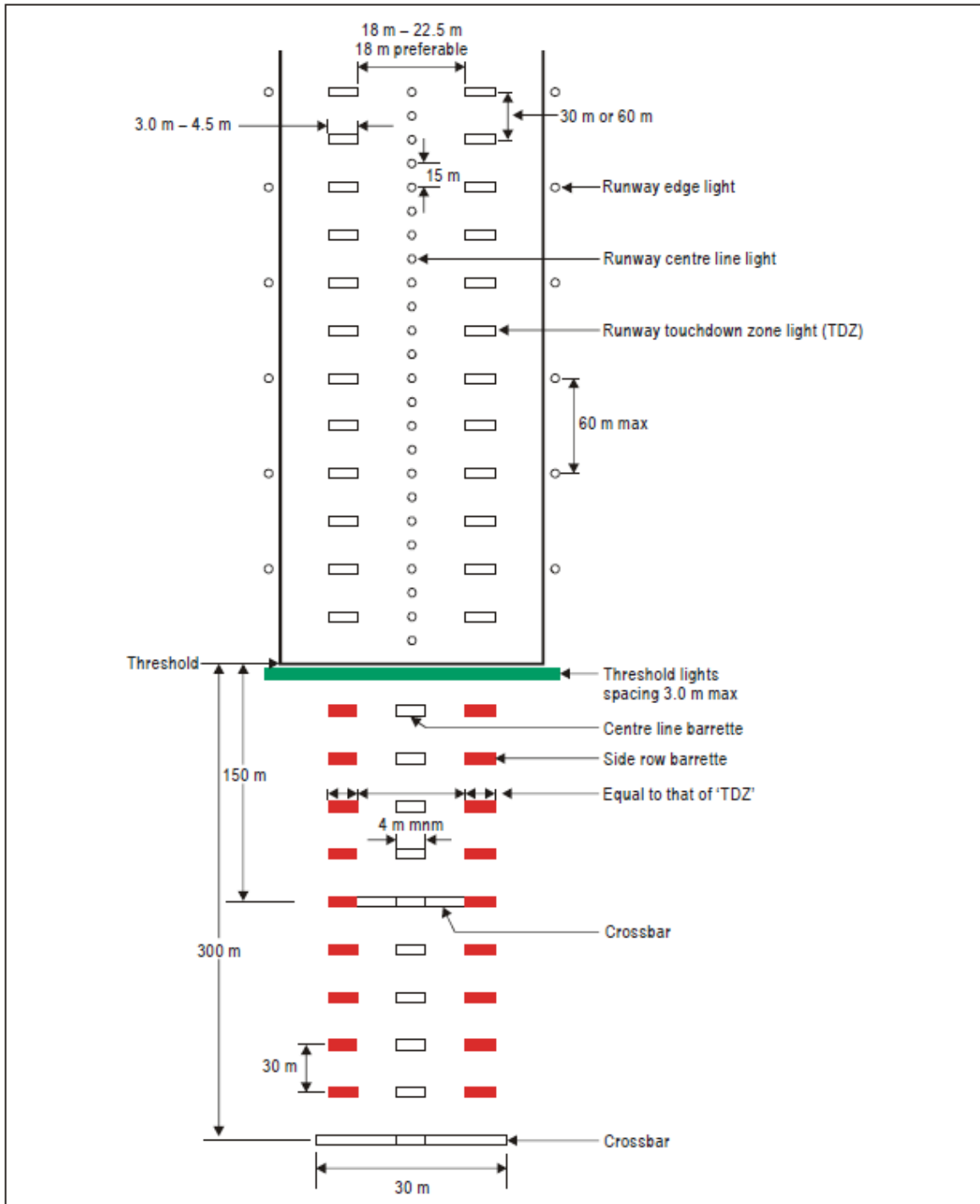

Figure 8-11. Inner 300m approach and runway lighting for precision approach runways, categories II and III

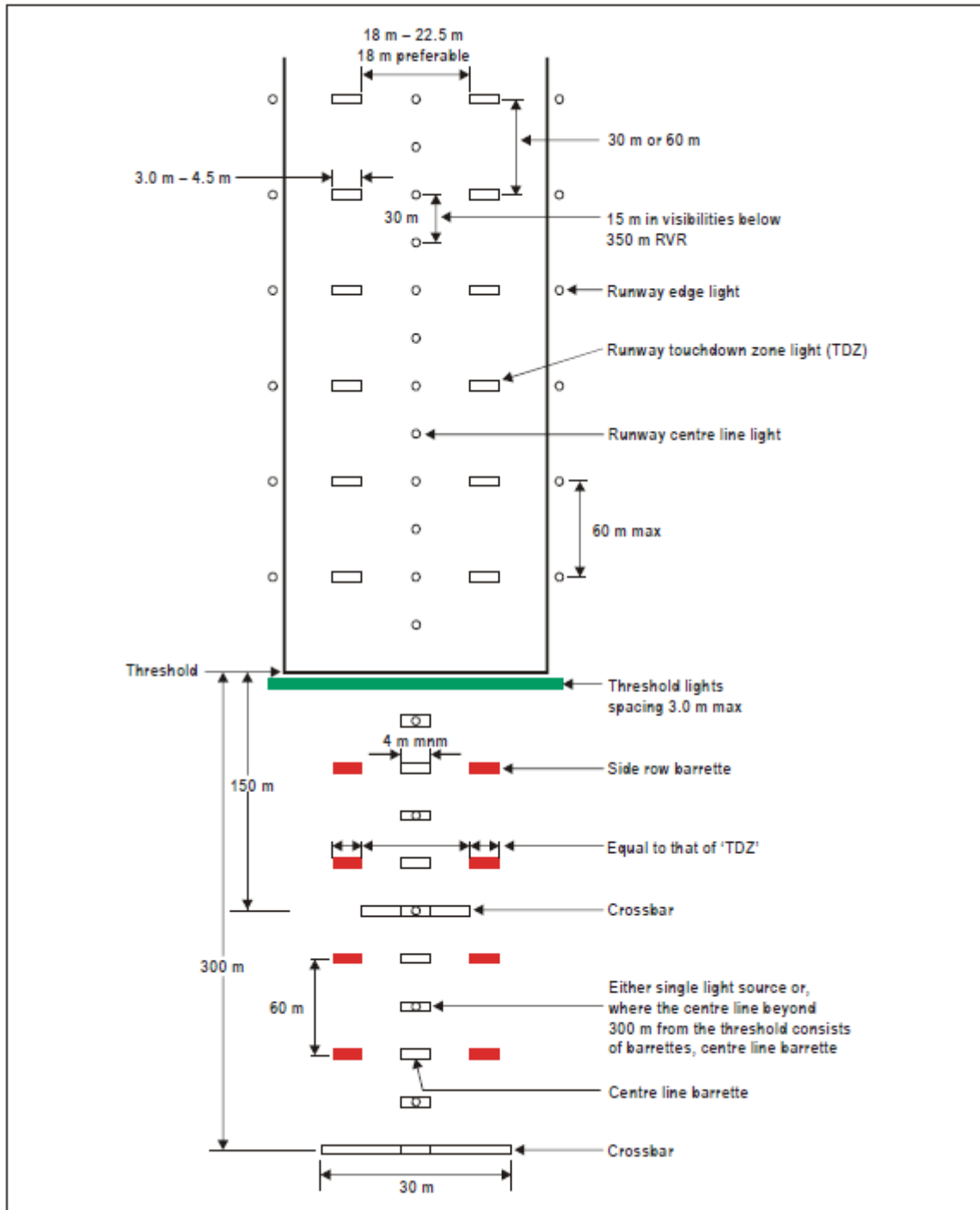

Figure 8-12. Inner 300m approach and runway lighting for precision approach runways, categories II and III, where the serviceability levels of the lights specified as maintenance objectives in Chapter 13 can be demonstrated



8.3.3.24 Where the additional crossbars described in paragraph 8.3.3.23 are incorporated in the system, the outer ends of these crossbars must lie on two straight lines that either are parallel to the centre line or converge to meet the runway centre line 300m from the threshold.

8.3.3.25 The system must lie as nearly as practicable in the horizontal plane passing through the threshold, provided that:

- (a) no object other than an ILS or MLS azimuth antenna must protrude through the plane of the approach lights within a distance of 60m from the centre line of the system; and
- (b) no light other than a light located within the central part of a crossbar or a centre line barrette (not their extremities) must be screened from an approaching aircraft.

Any ILS or MLS azimuth antenna protruding through the plane of the lights must be treated as an obstacle and marked and lighted accordingly.

#### *Characteristics*

8.3.3.26 The centre line of a precision approach category II and III lighting system for the first 300m from the threshold must consist of barrettes showing variable white, except that, where the threshold is displaced 300m or more, the centre line may consist of single light sources showing variable white. Where the serviceability level of the approach lights specified as maintenance objectives in paragraph 13.4.4 can be demonstrated, the centre line of a precision approach category II and III lighting system for the first 300m from the threshold may consist of either:

- (a) barrettes, where the centre line beyond 300m from the threshold consists of barrettes as described in paragraph 8.3.4.28 a); or
- (b) alternate single light sources and barrettes, where the centre line beyond 300m from the threshold consists of single light sources as described in paragraph 8.3.4.28 b), with the innermost single light source located 30m and the innermost barrette located 60m from the threshold; or
- (c) single light sources where the threshold is displaced 300m or more;

all of which must show variable white.

8.3.3.27 Beyond 300m from the threshold each centre line light position must consist of either:

- (a) a barrette as used on the inner 300m; or
- (b) two light sources in the central 300m of the centre line and three light sources in the outer 300m of the centre line;

all of which must show variable white.

8.3.3.28 Where the serviceability level of the approach lights specified as maintenance objectives in paragraph 13.4.4 can be demonstrated, beyond 300m from the threshold each centre line light position may consist of either:

- (a) a barrette; or
- (b) a single light source;

all of which must show variable white.

8.3.3.29 The barrettes must be at least 4m in length. When barrettes are composed of lights approximating to point sources, the lights must be uniformly spaced at intervals of not more than 1.5m.

8.3.3.30 If the centre line beyond 300m from the threshold consists of barrettes which are supplemented by flashing lights, each flashing light at each barrette must be flashed twice a second in sequence, beginning with the outermost light and progressing toward the threshold to the innermost light of the system. The design of the electrical circuit must be such that these lights can be operated independently of the other lights of the approach lighting system.

8.3.3.31 The side row must consist of barrettes showing red. The length of a side row barrette and the spacing of its lights must be equal to those of the touchdown zone light barrettes.

8.3.3.32 The lights forming the crossbars must be fixed lights showing variable white. The lights must be uniformly spaced at intervals of not more than 2.7m.

8.3.3.33 The intensity of the red lights must be compatible with the intensity of the white lights.

8.3.3.34 The lights must be in accordance with the specifications of Appendix 3, Figures A3-1 and A3-2<sup>97</sup>.

---

<sup>97</sup> The flight path envelopes used in the design of these lights are given in ICAO Annex 14 Vol. I, Attachment A, Figure A-6.

### 8.3.4 Visual approach slope indicator systems

#### Application

8.3.4.1 A visual approach slope indicator system<sup>98</sup> must be provided to serve the approach to a runway whether or not the runway is served by other visual approach aids or by non-visual aids, where one or more of the following conditions exist:

- (a) the runway is used by turbojet or other aeroplanes with similar approach guidance requirements;
- (b) the pilot of any type of aeroplane may have difficulty in judging the approach due to:
  - (1) inadequate visual guidance such as is experienced during an approach over water or featureless terrain by day or in the absence of sufficient extraneous lights in the approach area by night, or
  - (2) misleading information such as is produced by deceptive surrounding terrain or runway slopes;
- (c) the presence of objects in the approach area may involve serious hazard if an aeroplane descends below the normal approach path, particularly if there are no non-visual or other visual aids to give warning of such objects;
- (d) physical conditions at either end of the runway present a serious hazard in the event of an aeroplane undershooting or overrunning the runway; and
- (e) terrain or prevalent meteorological conditions are such that the aeroplane may be subjected to unusual turbulence during approach.

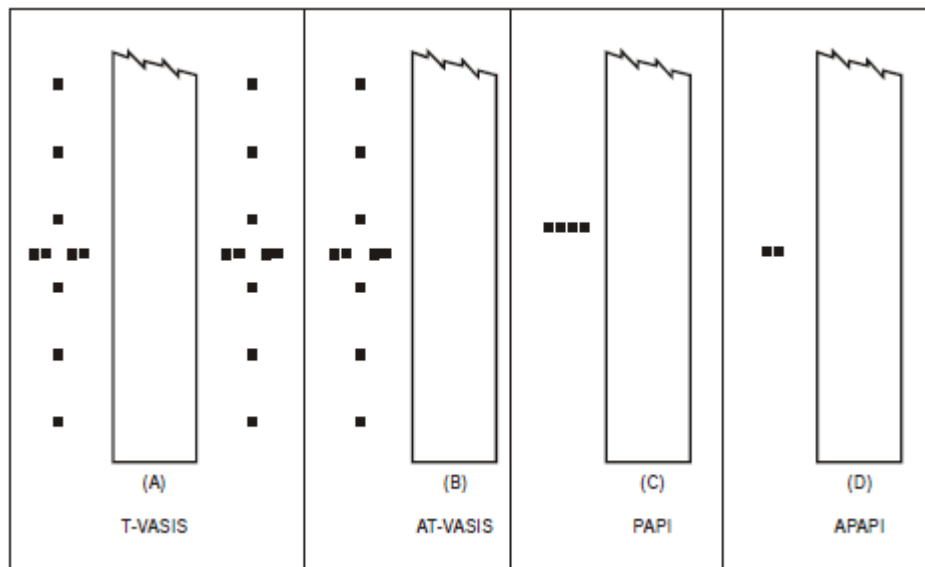

Figure 8-13. Visual approach slope indicator systems

<sup>98</sup> Guidance on the priority of installation of visual approach slope indicator systems is contained in ICAO Annex 14 Vol. I, Attachment A, Section 12.

8.3.4.2 The standard visual approach slope indicator systems must consist of the following:

- (a) T-VASIS and AT-VASIS conforming to the specifications contained in 8.3.4.5 to 8.3.4.21 inclusive;
- (b) PAPI and APAPI systems conforming to the specifications contained in 8.3.4.22 to 8.3.4.39 inclusive;

as shown in Figure 8-13.

8.3.4.3 PAPI, T-VASIS or AT-VASIS must be provided where the code number is 3 or 4 when one or more of the conditions specified in paragraph 8.3.4.1 exist.

8.3.4.4 PAPI or APAPI must be provided where the code number is 1 or 2 when one or more of the conditions specified in paragraph 8.3.4.1 exist.

### T-VASIS and AT-VASIS

#### *Description*

8.3.4.5 The T-VASIS must consist of twenty light units symmetrically disposed about the runway centre line in the form of two wing bars of four light units each, with bisecting longitudinal lines of six lights, as shown in Figure 8-14.

8.3.4.6 The AT-VASIS must consist of ten light units arranged on one side of the runway in the form of a single wing bar of four light units with a bisecting longitudinal line of six lights.

8.3.4.7 The light units must be constructed and arranged in such a manner that the pilot of an aeroplane during an approach will:

- (a) when above the approach slope, see the wing bar(s) white, and one, two or three fly-down lights, the more fly-down lights being visible the higher the pilot is above the approach slope;
- (b) when on the approach slope, see the wing bar(s) white; and
- (c) when below the approach slope, see the wing bar(s) and one, two or three fly-up lights white, the more fly-up lights being visible the lower the pilot is below the approach slope; and when well below the approach slope, see the wing bar(s) and the three fly-up lights red.

When on or above the approach slope, no light must be visible from the fly-up light units; when on or below the approach slope, no light must be visible from the fly-down light units.

#### *Siting*

8.3.4.8 The light units must be located as shown in Figure 8-17, subject to the installation tolerances given therein.

*Characteristics of the light units*

8.3.4.9 The systems must be suitable for both day and night operations.

8.3.4.10 The light distribution of the beam of each light unit must be of fan shape showing over a wide arc in azimuth in the approach direction. The wing bar light units must produce a beam of white light from 1°54' vertical angle up to 6° vertical angle and a beam of red light from 0° to 1°54' vertical angle. The fly-down light units must produce a white beam extending from an elevation of 6° down to approximately the approach slope, where it must have a sharp cut-off. The fly-up light units must produce a white beam from approximately the approach slope down to 1°54' vertical angle and a red beam below a 1°54' vertical angle. The angle of the top of the red beam in the wing bar units and fly-up units may be increased to comply with paragraph 8.3.4.20.

8.3.4.11 The light intensity distribution of the fly-down, wing bar and fly-up light units must be as shown in Appendix 3, Figure A3-22.

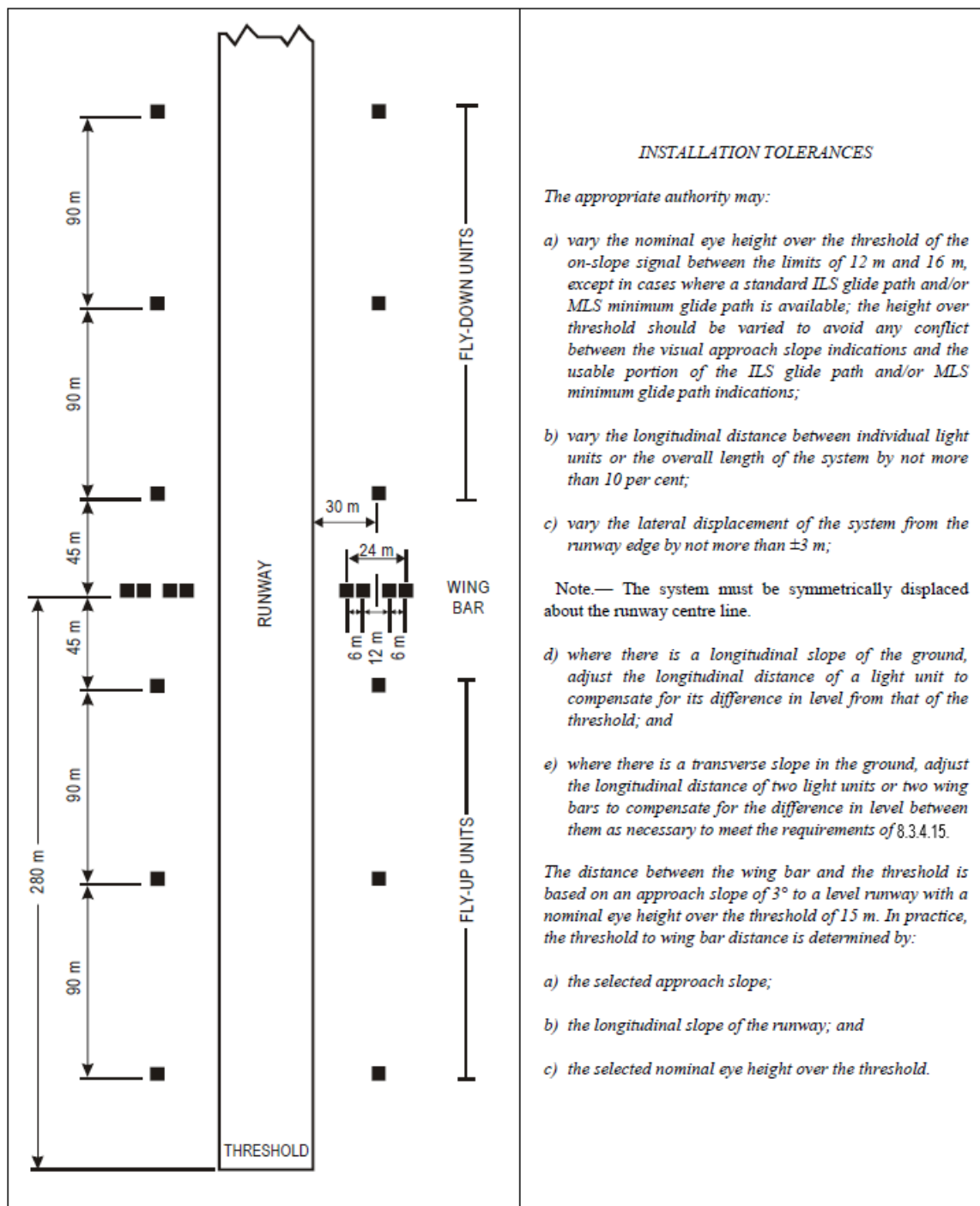

Figure 8-14. Siting of light units for T-VASIS

8.3.4.12 The colour transition from red to white in the vertical plane must be such as to appear to an observer, at a distance of not less than 300m, to occur over a vertical angle of not more than  $15^\circ$ .

8.3.4.13 At full intensity the red light must have a Y coordinate not exceeding 0.320.

8.3.4.14 A suitable intensity control must be provided to allow adjustments to meet the prevailing conditions and to avoid dazzling the pilot during approach and landing.

- 8.3.4.15 The light units forming the wing bars, or the light units forming a fly-down or a fly-up matched pair, must be mounted so as to appear to the pilot of an approaching aeroplane to be substantially in a horizontal line. The light units must be mounted as low as possible and must be frangible.
- 8.3.4.16 The light units must be so designed that deposits of condensation, dirt, etc., on optically transmitting or reflecting surfaces must interfere to the least possible extent with the light signals and must in no way affect the elevation of the beams or the contrast between the red and white signals. The construction of the light units must be such as to minimize the probability of the slots being wholly or partially blocked by deposits of condensation.

*Approach slope and elevation setting of light beams*

- 8.3.4.17 The approach slope must be appropriate for use by the aeroplanes using the approach.
- 8.3.4.18 When the runway on which a T-VASIS is provided is equipped with an ILS and/or MLS, the siting and elevations of the light units must be such that the visual approach slope conforms as closely as possible with the glide path of the ILS and/or the minimum glide path of the MLS, as appropriate.
- 8.3.4.19 The elevation of the beams of the wing bar light units on both sides of the runway must be the same. The elevation of the top of the beam of the fly-up light unit nearest to each wing bar, and that of the bottom of the beam of the fly-down light unit nearest to each wing bar, must be equal and must correspond to the approach slope. The cut-off angle of the top of the beams of successive fly-up light units must decrease by 5' of arc in angle of elevation at each successive unit away from the wing bar. The cut-in angle of the bottom of the beam of the fly-down light units must increase by 7' of arc at each successive unit away from the wing bar (See Figure 8-15).
- 8.3.4.20 The elevation setting of the top of the red light beams of the wing bar and fly-up light units must be such that, during an approach, the pilot of an aeroplane to whom the wing bar and three fly-up light units are visible would clear all objects in the approach area by a safe margin if any such light did not appear red.
- 8.3.4.21 The azimuth spread of the light beam must be suitably restricted where an object located outside the obstacle protection surface<sup>99</sup> of the system, but within the lateral limits of its light beam, is found to extend above the plane of the obstacle protection surface and an aeronautical study indicates that the object could adversely affect the safety of operations. The extent of the restriction must be such that the object remains outside the confines of the light beam.

---

<sup>99</sup> See paragraphs 8.3.4.40 to 8.3.4.44 concerning the related obstacle protection surface.

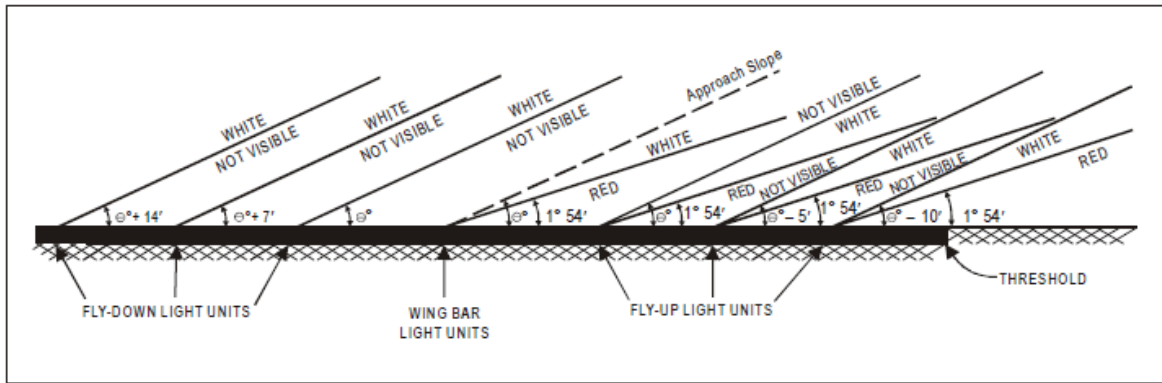

Figure 8-15. Light beams and elevation settings of T-VASIS and AT-VASIS

## PAPI and APAPI

### *Description*

8.3.4.22 The PAPI system must consist of a wing bar of 4 sharp transition multi-lamp (or paired single lamp) units equally spaced. The system<sup>100</sup> must be located on the left side of the runway unless it is physically impracticable to do so.

8.3.4.23 The APAPI system must consist of a wing bar of 2 sharp transition multi-lamp (or paired single lamp) units. The system<sup>100</sup> must be located on the left side of the runway unless it is physically impracticable to do so.

8.3.4.24 The wing bar of a PAPI must be constructed and arranged in such a manner that a pilot making an approach will:

- (a) when on or close to the approach slope, see the two units nearest the runway as red and the two units farthest from the runway as white;
- (b) when above the approach slope, see the one unit nearest the runway as red and the three units farthest from the runway as white; and when further above the approach slope, see all the units as white; and
- (c) when below the approach slope, see the three units nearest the runway as red and the unit farthest from the runway as white; and when further below the approach slope, see all the units as red.

8.3.4.25 The wing bar of an APAPI must be constructed and arranged in such a manner that a pilot making an approach will:

- (a) when on or close to the approach slope, see the unit nearer the runway as red and the unit farther from the runway as white;
- (b) when above the approach slope, see both the units as white; and
- (c) when below the approach slope, see both the units as red.

<sup>100</sup> Where a runway is used by aircraft requiring visual roll guidance which is not provided by other external means, then a second wing bar may be provided on the opposite side of the runway.



*Siting*

8.3.4.26 The light units must be located as in the basic configuration illustrated in Figure 8-16, subject to the installation tolerances given therein. The units forming a wing bar must be mounted so as to appear to the pilot of an approaching aeroplane to be substantially in a horizontal line. The light units must be mounted as low as possible and must be frangible.

*Characteristics of the light units*

8.3.4.27 The system must be suitable for both day and night operations.

8.3.4.28 The colour transition from red to white in the vertical plane must be such as to appear to an observer, at a distance of not less than 300 m, to occur within a vertical angle of not more than 3'.

8.3.4.29 At full intensity the red light must have a Y coordinate not exceeding 0.320.

8.3.4.30 The light intensity distribution of the light units<sup>101</sup> must be as shown in Appendix 3, Figure A3-23.

8.3.4.31 Suitable intensity control must be provided so as to allow adjustment to meet the prevailing conditions and to avoid dazzling the pilot during approach and landing.

8.3.4.32 Each light unit must be capable of adjustment in elevation so that the lower limit of the white part of the beam may be fixed at any desired angle of elevation between 1°30' and at least 4°30' above the horizontal.

8.3.4.33 The light units must be so designed that deposits of condensation, dirt, etc., on optically transmitting or reflecting surfaces must interfere to the least possible extent with the light signals and must not affect the contrast between the red and white signals and the elevation of the transition sector.

---

<sup>101</sup> See ICAO Aerodrome Design Manual (Doc 9157), Part 4 for additional guidance on the characteristics of light units.

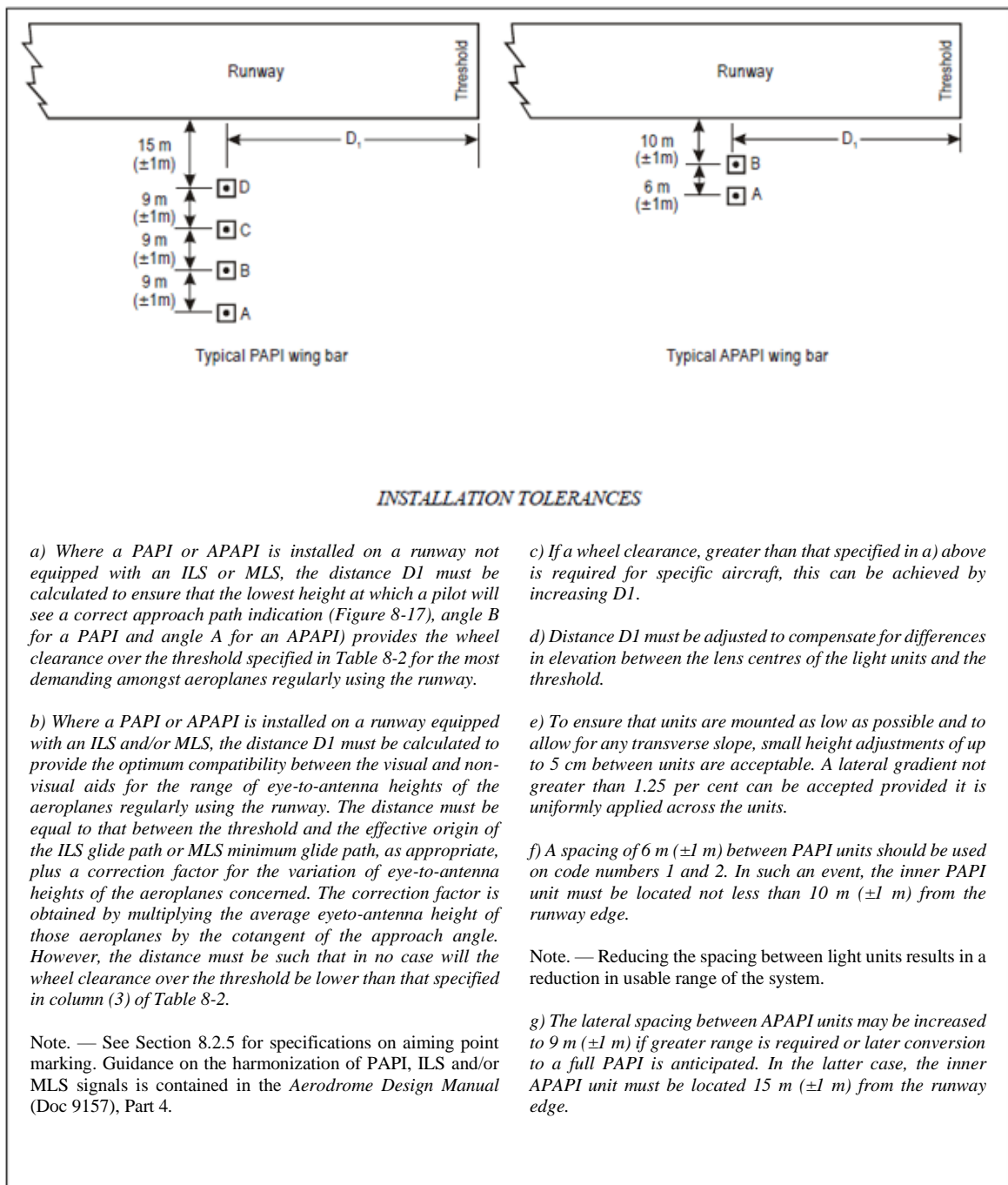

Figure 8-16. Siting of PAPI and APAPI

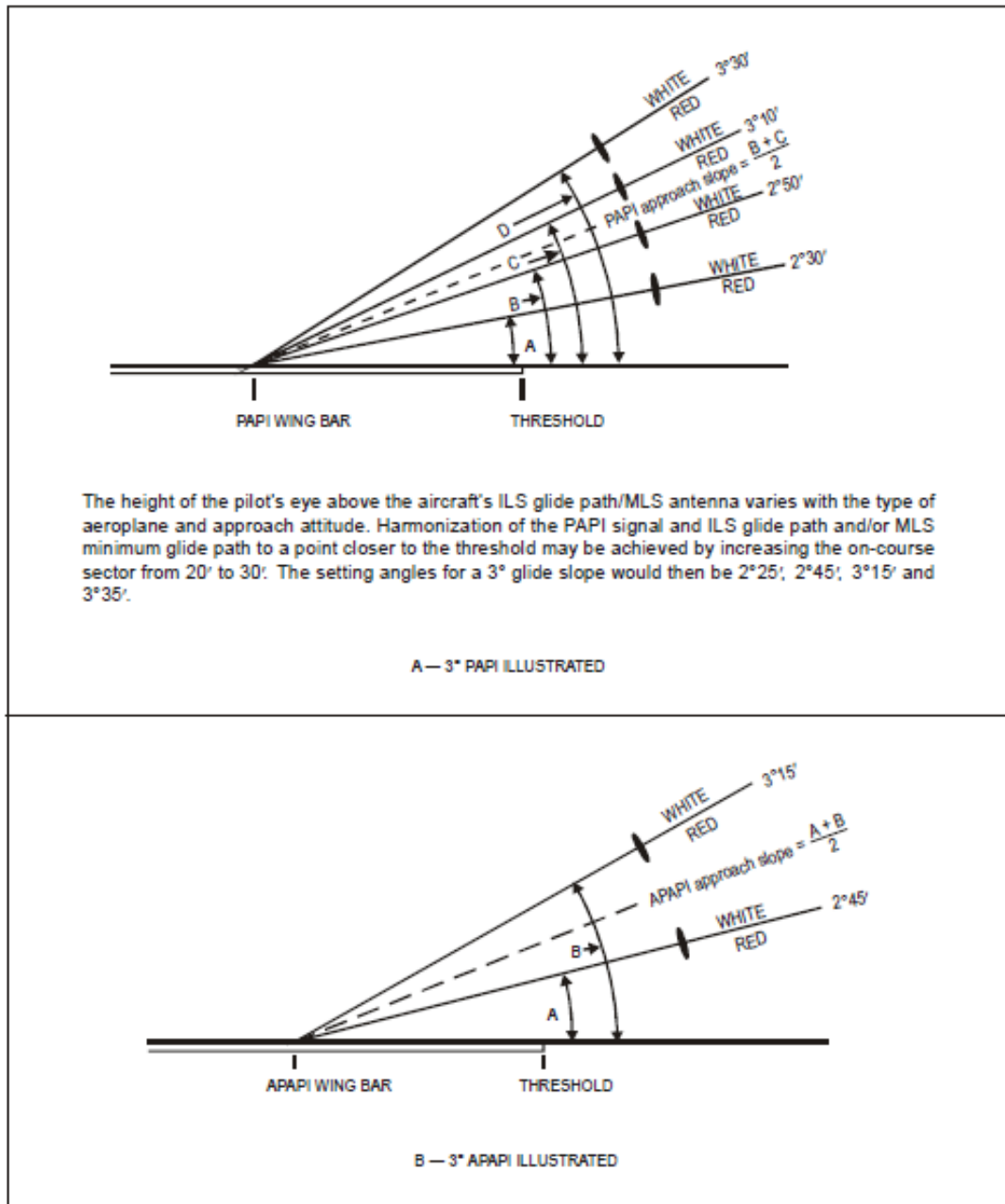

Figure 8-17. Light beams and angle of elevation setting of PAPI and APAPI

Table 8-2. Wheel clearance over threshold for PAPI and APAPI

Eye-to-wheel height of aeroplane in the approach configuration <sup>a</sup>	Desired wheel clearance (metres) <sup>b,c</sup>	Minimum wheel clearance (metres) <sup>d</sup>
(1)	(2)	(3)
up to but not including 3 m	6	3 <sup>e</sup>
3 m up to but not including 5 m	9	4
5 m up to but not including 8 m	9	5
8 m up to but not including 14 m	9	6

- In selecting the eye-to-wheel height group, only aeroplanes meant to use the system on a regular basis shall be considered. The most demanding amongst such aeroplanes shall determine the eye-to-wheel height group.
- Where practicable the desired wheel clearances shown in column (2) shall be provided.
- The wheel clearances in column (2) may be reduced to no less than those in column (3) where an aeronautical study indicates that such reduced wheel clearances are acceptable.
- When a reduced wheel clearance is provided at a displaced threshold it shall be ensured that the corresponding desired wheel clearance specified in column (2) will be available when an aeroplane at the top end of the eye-to-wheel height group chosen overflies the extremity of the runway.
- This wheel clearance may be reduced to 1.5 m on runways used mainly by light-weight non-turbojet aeroplanes.

#### Approach slope and elevation setting of light units

8.3.4.34 The approach slope as defined in Figure 8-17 must be appropriate for use by the aeroplanes using the approach.

8.3.4.35 When the runway is equipped with an ILS and/or MLS, the siting and the angle of elevation of the light units must be such that the visual approach slope conforms as closely as possible with the glide path of the ILS and/or the minimum glide path of the MLS, as appropriate.

8.3.4.36 The angle of elevation settings of the light units in a PAPI wing bar must be such that, during an approach, the pilot of an aeroplane observing a signal of one white and three reds will clear all objects in the approach area by a safe margin (see Table 8-2).

8.3.4.37 The angle of elevation settings of the light units in an APAPI wing bar must be such that, during an approach, the pilot of an aeroplane observing the lowest onslope signal, i.e. one white and one red, will clear all objects in the approach area by a safe margin (see Table 8-2).

8.3.4.38 The azimuth spread of the light beam must be suitably restricted where an object located outside the obstacle protection surface<sup>102</sup> of the PAPI or APAPI system, but within the lateral limits of its light beam, is found to extend above the plane of the obstacle protection surface and an aeronautical study indicates that the object could adversely affect the safety of operations. The extent of the restriction must be such that the object remains outside the confines of the light beam.

8.3.4.39 Where wing bars are installed on each side of the runway to provide roll guidance, corresponding units must be set at the same angle so that the signals of each wing bar change symmetrically at the same time.

<sup>102</sup> See paragraphs 8.3.4.40 to 8.3.4.44 concerning the related obstacle protection surface.

Obstacle protection surface<sup>103</sup>

8.3.4.40 An obstacle protection surface must be established when it is intended to provide a visual approach slope indicator system.

8.3.4.41 The characteristics of the obstacle protection surface, i.e. origin, divergence, length and slope must correspond to those specified in the relevant column of Table 8-3 and in Figure 8-18.

Table 8-3 – Dimensions and slopes of the obstacle protection surface

Surface dimensions	Runway type/code number							
	Non-instrument				Instrument			
	Code number				Code number			
	1	2	3	4	1	2	3	4
Length of inner edge	60 m	80 m <sup>a</sup>	150 m	150 m	150 m	150 m	300 m	300 m
Distance from the visual approach slope indicator system <sup>e</sup>	D <sub>1</sub> + 30 m	D <sub>1</sub> + 60 m	D <sub>1</sub> + 60 m	D <sub>1</sub> + 60 m	D <sub>1</sub> + 60 m	D <sub>1</sub> + 60 m	D <sub>1</sub> + 60 m	D <sub>1</sub> + 60 m
Divergence (each side)	10%	10%	10%	10%	15%	15%	15%	15%
Total length	7 500 m	7 500 m <sup>b</sup>	15 000 m	15 000 m	7 500 m	7 500 m <sup>b</sup>	15 000 m	15 000 m
Slope								
a) T-VASIS and AT-VASIS	- <sup>c</sup>	1.9°	1.9°	1.9°	-	1.9°	1.9°	1.9°
b) PAPI <sup>d</sup>	-	A-0.57°	A-0.57°	A-0.57°	A-0.57°	A-0.57°	A-0.57°	A-0.57°
c) APAPI <sup>d</sup>	A-0.9°	A-0.9°	-	-	A-0.9°	A-0.9°	-	-
a. This length is to be increased to 150 m for a T-VASIS and AT-VASIS.								
b. This length is to be increased to 15 000 m for a T-VASIS and AT-VASIS.								
c. No slope has been specified if a system is unlikely to be used on runway type/code number indicated.								
d. Angles as indicated in Figure 8-17.								
e. D <sub>1</sub> is the distance of the visual approach slope indicator system from threshold prior to any displacement to remedy object penetration of the obstacle protection surface (refer to Figure 8-16). The start of the obstacle protection surface is fixed to the visual approach slope indicator system location, such that displacement of the PAPI results in an equal displacement of the start of the obstacle protection surface. See 8.3.5.44(e).								

<sup>103</sup> The following specifications apply to T-VASIS, AT-VASIS, PAPI and APAPI.

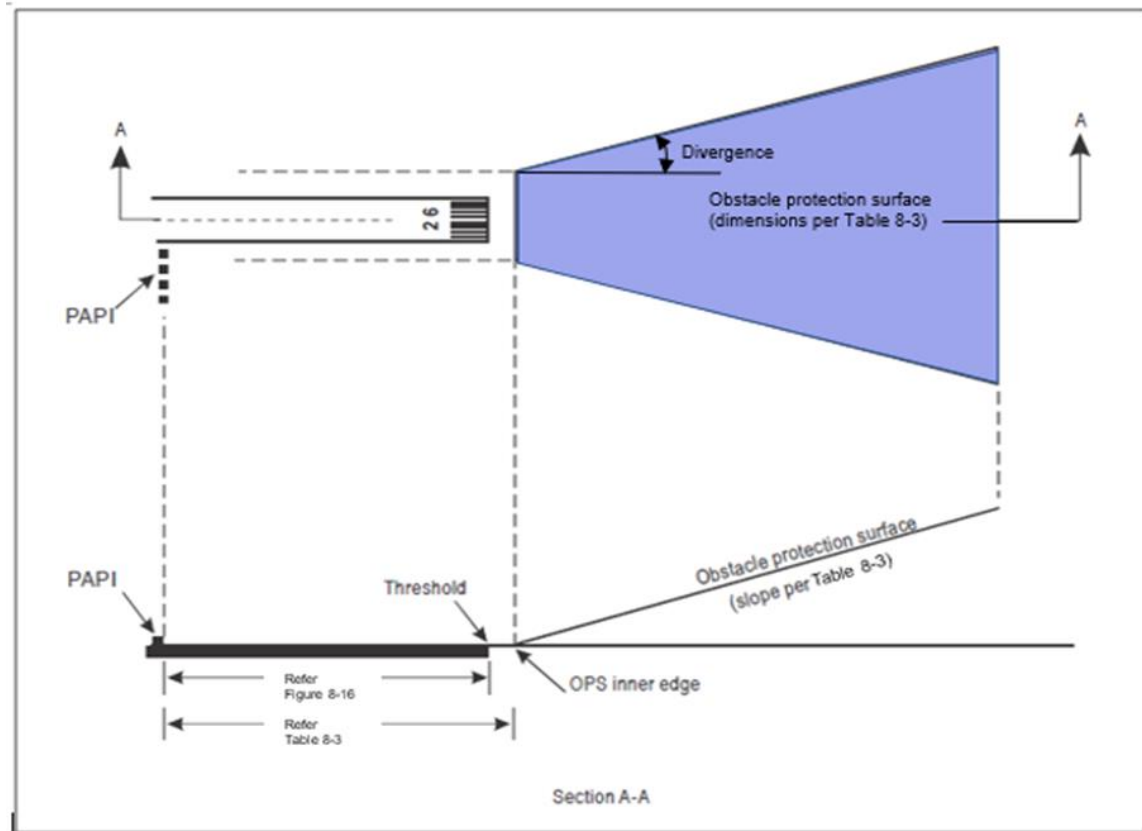

Figure 8-18. Obstacle protection surface for visual approach slope indicator systems

8.3.4.42 New objects or extensions of existing objects must not be permitted above an obstacle protection surface except when, the new object or extension would be shielded<sup>104</sup> by an existing immovable object.

8.3.4.43 Existing objects above an obstacle protection surface must be removed except when, the object is shielded by an existing immovable object, or after aeronautical study it is determined that the object would not adversely affect the safety of operations of aeroplanes.

8.3.4.44 Where an aeronautical study indicates that an existing object extending above an obstacle protection surface could adversely affect the safety of operations of aeroplanes, one or more of the following measures must be taken<sup>105</sup>:

- (a) remove the object;
- (b) suitably raise the approach slope of the system;
- (c) reduce the azimuth spread of the system so that the object is outside the confines of the beam;
- (d) displace the axis of the system and its associated obstacle protection surface by no more than 5°; and
- (e) suitably displace the system upwind of the threshold<sup>106</sup> such that the object no longer penetrates the obstacle protection surface.

<sup>104</sup> Circumstances in which the shielding principle may reasonably be applied are described in the ICAO Airport Services Manual (Doc 9137), Part 6.

<sup>105</sup> Guidance is contained in the ICAO Aerodrome Design Manual (Doc 9157), Part 4.

<sup>106</sup> The displacement of the system upwind of the threshold reduces the operational landing distance.

### **8.3.5 Runway threshold identification lights**

#### *Location*

8.3.5.1 Runway threshold identification lights must be located symmetrically about the runway centre line, in line with the threshold and approximately 10m outside each line of runway edge lights.

#### *Characteristics*

8.3.5.2 The lights must be visible only in the direction of approach to the runway.

### **8.3.6 Runway edge lights**

8.3.6.1 Runway edge lights must be provided for a runway intended for use at night or for a precision approach runway intended for use by day or night.

#### *Location*

8.3.6.2 Runway edge lights must be placed along the full length of the runway and must be in two parallel rows equidistant from the centre line.

8.3.6.3 Runway edge lights must be placed along the edges of the area declared for use as the runway or outside the edges of the area at a distance of not more than 3m.

8.3.6.4 The lights must be uniformly spaced in rows at intervals of not more than 60m for an instrument runway, and at intervals of not more than 100m for a non-instrument runway. The lights on opposite sides of the runway axis must be on lines at right angles to that axis. At intersections of runways, lights may be spaced irregularly or omitted, provided that adequate guidance remains available to the pilot.

#### *Characteristics*

8.3.6.5 Runway edge lights must be fixed lights showing variable white, except that:

- (a) in the case of a displaced threshold, the lights between the beginning of the runway and the displaced threshold must show red in the approach direction; and
- (b) a section of the lights 600m or one-third of the runway length, whichever is the less, at the remote end of the runway from the end at which the take-off run is started, may show yellow.

8.3.6.6 The runway edge lights must show at all angles in azimuth necessary to provide guidance to a pilot landing or taking off in either direction. When the runway edge lights are intended to provide circling guidance, they must show at all angles in azimuth

8.3.6.7 In all angles of azimuth required in paragraph 8.3.6.6, runway edge lights must show at angles up to 15° above the horizontal with an intensity adequate for the conditions of visibility and ambient light in which use of the runway for take-off or landing is intended. In any case, the intensity must be at least 50 cd except that at an aerodrome without extraneous lighting the intensity of the lights may be reduced to not less than 25 cd to avoid dazzling the pilot.

8.3.6.8 Runway edge lights on a precision approach runway must be in accordance with the specifications of Appendix 3, Figure A3-9 or A3-10.

### **8.3.7 Runway threshold and wing bar lights**

#### *Application of runway threshold lights*

8.3.7.1 Runway threshold lights must be provided for a runway equipped with runway edge lights except on a non-instrument or non-precision approach runway where the threshold is displaced, and wing bar lights are provided.

#### *Location of runway threshold lights*

8.3.7.2 When a threshold is at the extremity of a runway, the threshold lights must be placed in a row at right angles to the runway axis as near to the extremity of the runway as possible and, in any case, not more than 3m outside the extremity. See Figure 8-19.

8.3.7.3 When a threshold is displaced from the extremity of a runway, threshold lights must be placed in a row at right angles to the runway axis at the displaced threshold.

8.3.7.4 Threshold lighting must consist of:

- (a) on a non-instrument or non-precision approach runway, at least six lights;
- (b) on a precision approach runway category I, at least the number of lights that would be required if the lights were uniformly spaced at intervals of 3m between the rows of runway edge lights; and
- (c) on a precision approach runway category II or III, lights uniformly spaced between the rows of runway edge lights at intervals of not more than 3m.

#### *Application of wing bar lights*

8.3.7.5 Wing bar lights must be provided on a non-instrument or non-precision approach runway where the threshold is displaced, and runway threshold lights are required but are not provided.

#### *Location of wing bar lights*

8.3.7.6 Wing bar lights must be symmetrically disposed about the runway centre line at the threshold in two groups, i.e. wing bars. Each wing bar must be formed by at least five lights extending at least 10m outward from, and at right angles to, the line of the runway edge lights, with the innermost light of each wing bar in the line of the runway edge lights.



CONDITION	LIGHTS	RUNWAY TYPE			
		NON-INSTRUMENT AND NON-PRECISION APPROACH RUNWAYS	PRECISION APPROACH RUNWAYS CATEGORY I	PRECISION APPROACH RUNWAYS CATEGORY II	PRECISION APPROACH RUNWAYS CATEGORY II
THRESHOLD AT RUNWAY EXTREMITY	RUNWAY THRESHOLD AND RUNWAY END LIGHTS	<p>8.2.7.2, 8.3.7.4 a), 8.3.8.2</p>	<p>8.3.7.2, 8.3.7.4b), 8.3.7.6, 8.3.8.2</p>	<p>8.3.7.2, 8.3.7.4 c), 8.3.7.6, 8.3.8.2</p>	<p>8.3.7.2, 8.3.7.4 c), 8.3.7.6, 8.3.8.2</p>
	THRESHOLD DISPLACED FROM RUNWAY EXTREMITY	<p>8.3.7.3, 8.3.7.4 a), 8.3.7.6</p>	<p>8.3.7.3, 8.3.7.4 b), 8.3.7.6</p>	<p>8.3.7.3, 8.3.7.4 c), 8.3.7.6</p>	<p>8.3.7.3, 8.3.7.4 c), 8.3.7.6</p>
	RUNWAY END LIGHTS		<p>8.3.8.2</p>		<p>8.3.8.2</p>

**LEGEND**

- UNIDIRECTIONAL LIGHT
- BIDIRECTIONAL LIGHT
- CONDITIONAL RECOMMENDATION

*Note.— The minimum number of lights are shown for a runway 45 m wide with runway edge lights installed at the edge.*

Figure 8-19. Arrangement of runway threshold and runway end lights

*Characteristics of runway threshold and wing bar lights*

- 8.3.7.7 Runway threshold and wing bar lights must be fixed unidirectional lights showing green in the direction of approach to the runway. The intensity and beam spread of the lights must be adequate for the conditions of visibility and ambient light in which use of the runway is intended.
- 8.3.7.8 Runway threshold lights on a precision approach runway must be in accordance with the specifications of Appendix 3, Figure A3-3.
- 8.3.7.9 Threshold wing bar lights on a precision approach runway must be in accordance with the specifications of Appendix 3, Figure A3-4.

**8.3.8 Runway end lights**

*Application*

- 8.3.8.1 Runway end lights must be provided for a runway equipped with runway edge lights<sup>107</sup>.

*Location*

- 8.3.8.2 Runway end lights must be placed on a line at right angles to the runway axis as near to the end of the runway as possible and, in any case, not more than 3 m outside the end. See Figure 8-19.

*Characteristics*

- 8.3.8.3 Runway end lights must be fixed unidirectional lights showing red in the direction of the runway. The intensity and beam spread of the lights must be adequate for the conditions of visibility and ambient light in which use of the runway is intended.
- 8.3.8.4 Runway end lights on a precision approach runway must be in accordance with the specifications of Appendix 3, Figure A3-8.

**8.3.9 Runway centre line lights**

*Application*

- 8.3.9.1 Runway centre line lights must be provided on a precision approach runway category II or III.
- 8.3.9.2 Runway centre line lights must be provided on a runway intended to be used for take-off with an operating minimum below an RVR of the order of 400 m.

---

<sup>107</sup> When the threshold is at the runway extremity, fittings serving as threshold lights may be used as runway end lights.

*Location*

8.3.9.3 Runway centre line lights<sup>108</sup> must be located along the centre line of the runway, except that the lights may be uniformly offset to the same side of the runway centre line by not more than 60 cm where it is not practicable to locate them along the centre line. The lights must be located from the threshold to the end at longitudinal spacing of approximately 15m. Where the serviceability level of the runway centre line lights specified as maintenance objectives in paragraphs 13.4.4 or 13.4.8, as appropriate, can be demonstrated and the runway is intended for use in runway visual range conditions of 350m or greater, the longitudinal spacing may be approximately 30m.

*Characteristics*

8.3.9.4 Runway centre line lights must be fixed lights showing variable white from the threshold to the point 900m from the runway end; alternate red and variable white from 900m to 300m from the runway end; and red from 300m to the runway end, except that for runways less than 1800m in length, the alternate red and variable white lights must extend from the mid-point of the runway usable for landing to 300 from the runway end<sup>109</sup>.

8.3.9.5 Runway centre line lights must be in accordance with the specifications of Appendix 3, Figure A3-6 or A3-7.

**8.3.10 Runway touchdown zone lights**

8.3.10.1 Touchdown zone lights must be provided in the touchdown zone of a precision approach runway category II or III.

*Location*

8.3.10.2 Touchdown zone lights must extend from the threshold for a longitudinal distance of 900m, except that, on runways less than 1800m in length, the system must be shortened so that it does not extend beyond the midpoint of the runway. The pattern must be formed by pairs of barrettes symmetrically located about the runway centre line. The lateral spacing between the innermost lights of a pair of barrettes must be equal to the lateral spacing selected for the touchdown zone marking. The longitudinal spacing between pairs of barrettes must be either 30m or 60m<sup>110</sup>.

*Characteristics*

8.3.10.3 A barrette must be composed of at least three lights with a spacing between the lights of not more than 1.5m.

8.3.10.4 Touchdown zone lights must be fixed unidirectional lights showing variable white.

8.3.10.5 Touchdown zone lights must be in accordance with the specifications of Appendix 3, Figure A3-5.

---

<sup>108</sup> Existing centre line lighting where lights are spaced at 7.5 m need not be replaced

<sup>109</sup> Care is required in the design of the electrical system to ensure that failure of part of the electrical system will not result in a false indication of the runway distance remaining.

<sup>110</sup> To allow for operations at lower visibility minima, it may be advisable to use a 30m longitudinal spacing between barrettes.

### 8.3.11 Simple touchdown zone lights

#### Location

8.3.11.1 Simple touchdown zone lights must be a pair of lights located on each side of the runway centre line 0.3m beyond the upwind edge of the final touchdown zone marking. The lateral spacing between the inner lights of the two pairs of lights must be equal to the lateral spacing selected for the touchdown zone marking. The spacing between the lights of the same pair must not be more than 1.5 m or half the width of the touchdown zone marking, whichever is greater. (See Figure 8-20)

#### Characteristics

8.3.11.2 Simple touchdown zone lights must be fixed unidirectional lights showing variable white, aligned so as to be visible to the pilot of a landing aeroplane in the direction of approach to the runway.

8.3.11.3 Simple touchdown zone lights must be in accordance with the specifications in Appendix 3, Figure A3-5<sup>111</sup>.

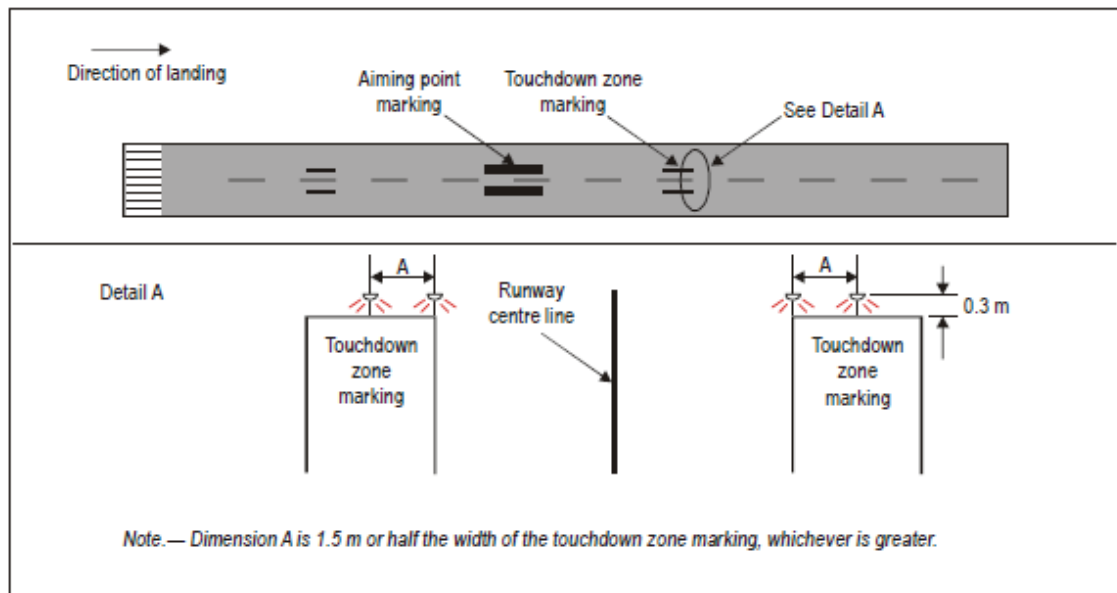

Figure 8-20 Simple touchdown zone lighting

### 8.3.12 Rapid exit taxiway indicator lights

#### Application

8.3.12.1 Rapid exit taxiway indicator lights must not be displayed in the event of any lamp failure or other failure that prevents the display of the light pattern depicted in Figure 8-21, in full.

<sup>111</sup> As a good operating practice, simple touchdown zone lights are supplied with power on a separate circuit to other runway lighting so that they may be used when other lighting is switched off.

*Location*

8.3.12.2 A set of rapid exit taxiway indicator lights must be located on the runway on the same side of the runway centre line as the associated rapid exit taxiway, in the configuration shown in Figure 8-21. In each set, the lights must be located 2m apart and the light nearest to the runway centre line must be displaced 2m from the runway centre line.

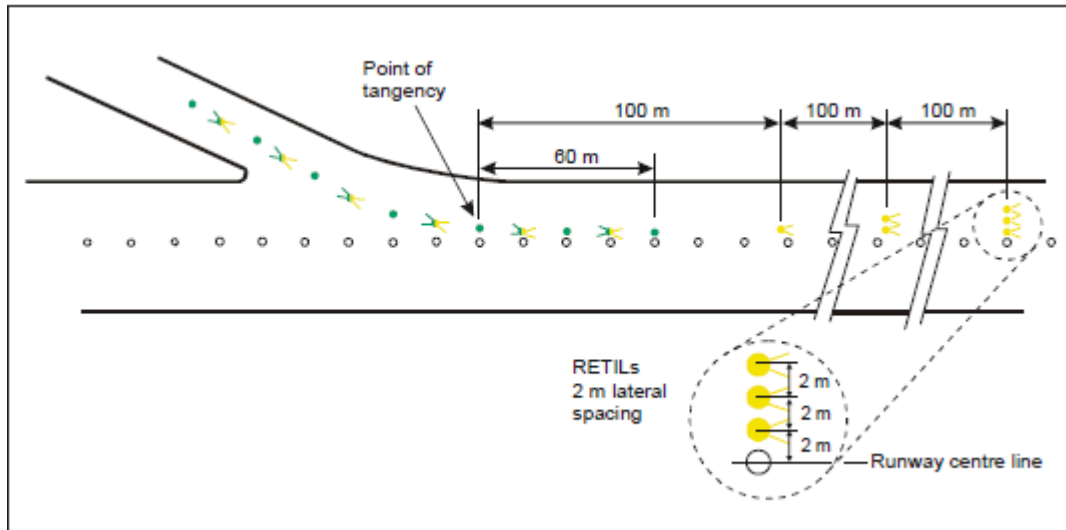

Figure 8-21. Rapid exit taxiway indicator lights (RETILs)

8.3.12.3 Where more than one rapid exit taxiway exists on a runway, the set of rapid exit taxiway indicator lights for each exit must not overlap when displayed.

*Characteristics*

8.3.12.4 Rapid exit taxiway indicator lights must be fixed unidirectional yellow lights, aligned so as to be visible to the pilot of a landing aeroplane in the direction of approach to the runway.

8.3.12.5 Rapid exit taxiway indicator lights must be in accordance with the specifications in Appendix 3, Figure A3-6 or Figure A3-7, as appropriate.

**8.3.13 Stopway lights**

8.3.13.1 Stopway lights must be provided for a stopway intended for use at night.

*Location*

8.3.13.2 Stopway lights must be placed along the full length of the stopway and must be in two parallel rows that are equidistant from the centre line and coincident with the rows of the runway edge lights. Stopway lights must also be provided across the end of a stopway on a line at right angles to the stopway axis as near to the end of the stopway as possible and, in any case, not more than 3m outside the end.

*Characteristics*

8.3.13.3 Stopway lights must be fixed unidirectional lights showing red in the direction of the runway.

**8.3.14 Taxiway centre line lights**

*Application*

8.3.14.1 Taxiway centre line lights must be provided on an exit taxiway, taxiway and apron intended for use in runway visual range conditions less than a value of 350m in such a manner as to provide continuous guidance between the runway centre line and aircraft stands, except that these lights need not be provided where the traffic density is light and taxiway edge lights and centre line marking provide adequate guidance.

8.3.14.2 Taxiway centre line lights must be provided on a runway forming part of a standard taxi-route and intended for taxiing in runway visual range conditions less than a value of 350m, except that these lights need not be provided where the traffic density is light and taxiway edge lights and centre line marking provide adequate guidance.

*Characteristics*

8.3.14.3 Taxiway centre line lights on a taxiway other than an exit taxiway and on a runway forming part of a standard taxi-route must be fixed lights showing green with beam dimensions such that the light is visible only from aeroplanes on or in the vicinity of the taxiway.

8.3.14.4 Taxiway centre line lights on an exit taxiway must be fixed lights. Alternate taxiway centre line lights must show green and yellow from their beginning near the runway centre line to the perimeter of the ILS/MLS critical/sensitive area or the lower edge of the inner transitional surface, whichever is farthest from the runway; and thereafter all lights must show green (See Figure 8-22). The first light in the exit centre line must always show green and the light nearest to the perimeter must always show yellow<sup>112</sup>.

8.3.14.5 Taxiway centre line lights must be in accordance with the specifications of:

- (a) Appendix 3, Figure A3-12, A3-13, or A3-14 for taxiways intended for use in runway visual range conditions of less than a value of 350m; and
- (b) Appendix 3, Figure A3-15 or A3-16 for other taxiways.

---

<sup>112</sup> Care is necessary to limit the light distribution of green lights on or near a runway so as to avoid possible confusion with threshold lights. The size of the ILS/MLS critical/sensitive area depends on the characteristics of the associated ILS/MLS and other factors. Guidance is provided in ICAO Annex 10, Volume I, Attachments C and G. See paragraph 8.4.3 for specifications on runway vacated signs.

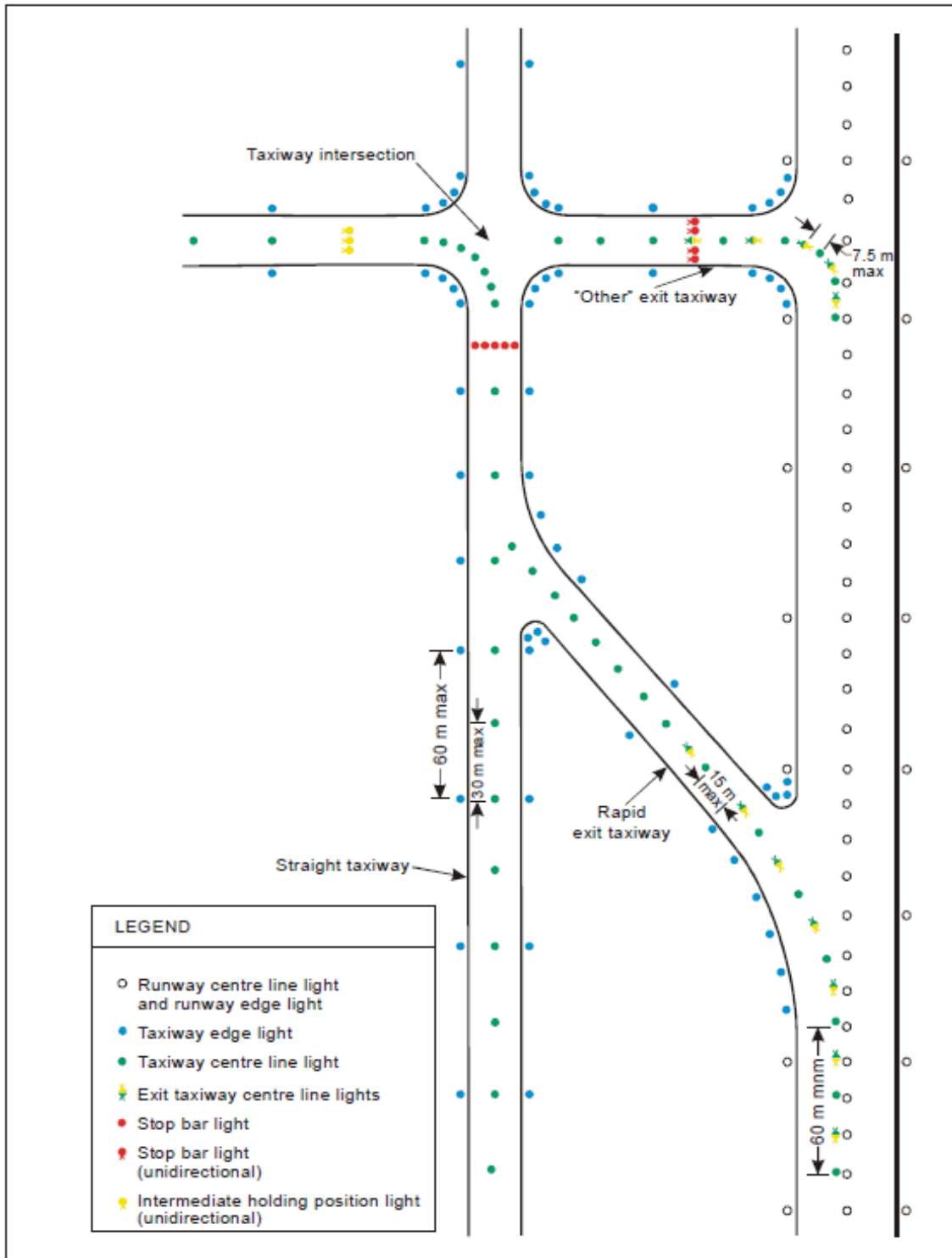

Figure 8-22. Taxiway lighting

### **8.3.15 Taxiway edge lights**

#### *Application*

- 8.3.15.1 Taxiway edge lights must be provided at the edges of a runway turn pad, holding bay, apron, etc. intended for use at night and on a taxiway not provided with taxiway centre line lights and intended for use at night, except that taxiway edge lights need not be provided where, considering the nature of the operations, adequate guidance can be achieved by surface illumination or other means<sup>113</sup>.
- 8.3.15.2 Taxiway edge lights must be provided on a runway forming part of a standard taxi-route and intended for taxiing at night where the runway is not provided with taxiway centre line lights<sup>114</sup>.

#### *Characteristics*

- 8.3.15.3 Taxiway edge lights must be fixed lights showing blue. The lights must show up to at least 75° above the horizontal and at all angles in azimuth necessary to provide guidance to a pilot taxiing in either direction. At an intersection, exit or curve the lights must be shielded as far as practicable so that they cannot be seen in angles of azimuth in which they may be confused with other lights.
- 8.3.15.4 The intensity of taxiway edge lights must be at least 2 cd from 0° to 6° vertical, and 0.2 cd at any vertical angles between 6° and 75°.

### **8.3.16 Runway turn pad lights**

#### *Application*

- 8.3.16.1 Runway turn pad lights must be provided for continuous guidance on a runway turn pad intended for use in runway visual range conditions less than a value of 350m, to enable an aeroplane to complete a 180-degree turn and align with the runway centre line.

#### *Characteristics*

- 8.3.16.2 Runway turn pad lights must be unidirectional fixed lights showing green with beam dimensions such that the light is visible only from aeroplanes on or approaching the runway turn pad.
- 8.3.16.3 Runway turn pad lights must be in accordance with the specifications of Appendix 3, Figure A3-13, A3-14 or A3-15, as appropriate.

---

<sup>113</sup> See paragraph 8.5.3 for taxiway edge markers.

<sup>114</sup> See paragraph 11.2.3 for provisions concerning the interlocking of runway and taxiway lighting systems.



### 8.3.17 Stop bars

#### *Application*

8.3.17.1 A stop bar must be provided at every runway-holding position serving a runway when it is intended that the runway will be used in runway visual range conditions less than a value of 550m, except where:

- (a) appropriate aids and procedures are available to assist in preventing inadvertent incursions of traffic onto the runway; or
- (b) operational procedures exist to limit, in runway visual range conditions less than a value of 550m, the number of:
  - (1) aircraft on the manoeuvring area to one at a time; and
  - (2) vehicles on the manoeuvring area to the essential minimum.

8.3.17.2 Where there is more than one stop bar associated with a taxiway/runway intersection, only one must be illuminated at any given time.

#### *Location*

8.3.17.3 Stop bars must be located across the taxiway at the point where it is desired that traffic stop. If a pair of additional elevated lights are added to each end of the stop bar where the in-pavement stop bar lights might be obscured from a pilot's view, these lights must be located not less than 3m from the taxiway edge.

#### *Characteristics*

8.3.17.4 Stop bars must consist of lights spaced at uniform intervals of no more than 3m across the taxiway, showing red in the intended direction(s) of approach to the intersection or runway-holding position<sup>115</sup>.

8.3.17.5 Stop bars installed at a runway-holding position must be unidirectional and must show red in the direction of approach to the runway.

8.3.17.6 If a pair of additional elevated lights are added to each end of the stop bar where the in-pavement stop bar lights might be obscured from a pilot's view, these lights must have the same characteristics as the lights in the stop bar but must be visible to approaching aircraft up to the stop bar position.

8.3.17.7 The intensity in red light and beam spreads of stop bar lights must be in accordance with the specifications in Appendix 3, Figures A3-12 through A3-16, as appropriate.

---

<sup>115</sup> Where necessary to enhance conspicuity of an existing stop bar, extra lights are installed uniformly.

8.3.17.8 The lighting circuit must be designed<sup>116</sup> so that:

- (a) stop bars located across entrance taxiways are selectively switchable;
- (b) stop bars located across taxiways intended to be used only as exit taxiways are switchable selectively or in groups;
- (c) when a stop bar is illuminated, any taxiway centre line lights installed beyond the stop bar must be extinguished for a distance of at least 90m; and
- (d) stop bars are interlocked with the taxiway centre line lights so that when the centre line lights beyond the stop bar are illuminated the stop bar is extinguished and vice versa.

### **8.3.18 Intermediate holding position lights**

#### *Application*

8.3.18.1 Except where a stop bar has been installed, intermediate holding position lights must be provided at an intermediate holding position intended for use in runway visual range conditions less than a value of 350m.

#### *Location*

8.3.18.2 Intermediate holding position lights must be located along the intermediate holding position marking at a distance of 0.3m prior to the marking.

#### *Characteristics*

8.3.18.3 Intermediate holding position lights must consist of three fixed unidirectional lights showing yellow in the direction of approach to the intermediate holding position with a light distribution similar to taxiway centre line lights if provided. The lights must be disposed symmetrically about and at right angle to the taxiway centre line, with individual lights spaced 1.5m apart.

### **8.3.19 Runway guard lights**

#### *Application*

8.3.19.1 Runway guard lights, Configuration A<sup>117</sup> must be provided at each taxiway/runway intersection associated with a runway intended for use in:

- (a) runway visual range conditions less than a value of 550m where a stop bar is not installed; and
- (b) runway visual range conditions of values between 550m and 1 200m where the traffic density is heavy.

---

<sup>116</sup> Care is required in the design of the electrical system to ensure that all of the lights of a stop bar will not fail at the same time. Guidance on this issue is given in the ICAO Aerodrome Design Manual (Doc 9157), Part 5.

<sup>117</sup> Runway guard lights, Configuration B may supplement Configuration A when deemed necessary. Guidance on the design, operation and the location of runway guard lights Configuration B is given in the ICAO Aerodrome Design Manual (Doc 9157), Part 4.

8.3.19.2 Where more than one runway-holding positions exist at a runway/taxiway intersection, only the set of runway guard lights associated with the operational runway-holding position must be illuminated.

*Location*

8.3.19.3 Runway guard lights, Configuration A, must be located at each side of the taxiway on the holding side of the runway-holding position marking. (See Figure 8-23)

8.3.19.4 Runway guard lights, Configuration B, must be located across the taxiway on the holding side of the runway-holding position marking.

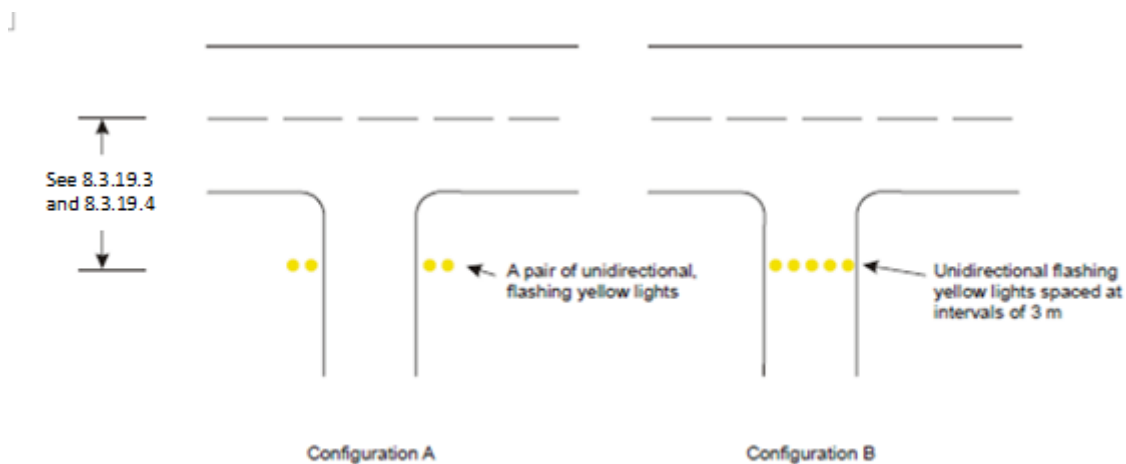

Figure 8-23. Runway guard lights

*Characteristics*

8.3.19.5 Runway guard lights, Configuration A, must consist of two pairs of yellow lights.

8.3.19.6 Runway guard lights, Configuration B, must consist of yellow lights spaced at intervals of 3m across the taxiway.

8.3.19.7 The light beam must be unidirectional and must show yellow in the direction of the approach to the runway-holding position<sup>118</sup>.

8.3.19.8 The lights in each unit of Configuration A must be illuminated alternately.

8.3.19.9 For Configuration B, adjacent lights must be alternately illuminated, and alternative lights must be illuminated in unison.

8.3.19.10 The lights must be illuminated between 30 and 60 cycles per minute and the light suppression and illumination periods must be equal and opposite in each light<sup>119</sup>.

<sup>118</sup> See the ICAO Aerodrome Design Manual (Doc 9157) Part 4 for guidance on orientation and aiming of runway guard lights.

<sup>119</sup> The optimum flash rate is dependent on the rise and fall times of the lamps used. Runway guard lights, Configuration A, installed on 6.6 ampere series circuits have been found to look best when operated at 45 to 50 flashes per minute per lamp. Runway guard lights, Configuration B, installed on 6.6 ampere series circuits have been found to look best when operated at 30 to 32 flashes per minute per lamp.

### **8.3.20 Apron floodlighting**

#### *Characteristics*

- 8.3.20.1 The spectral distribution of apron floodlights must be such that the colours used for aircraft marking connected with routine servicing, and for surface and obstacle marking, can be correctly identified.

### **8.3.21 Visual docking guidance system**

#### *Application*

- 8.3.21.1 A visual docking guidance system<sup>120</sup> must be provided when it is intended to indicate, by a visual aid, the precise positioning of an aircraft on an aircraft stand and other alternative means, such as marshalls, are not practicable.

#### *Characteristics*

- 8.3.21.2 The system must provide both azimuth and stopping guidance.
- 8.3.21.3 The azimuth guidance unit and the stopping position indicator must be adequate for use in all weather, visibility, background lighting and pavement conditions for which the system<sup>121</sup> is intended both by day and night, but must not dazzle the pilot.
- 8.3.21.4 The azimuth guidance unit and the stopping position indicator must be of a design such that:
- (a) a clear indication of malfunction of either or both is available to the pilot; and
  - (b) they can be turned off.
- 8.3.21.5 The azimuth guidance unit and the stopping position indicator must be located in such a way that there is continuity of guidance between the aircraft stand markings, the aircraft stand manoeuvring guidance lights, if present, and the visual docking guidance system.
- 8.3.21.6 The accuracy of the system must be adequate for the type of loading bridge and fixed aircraft servicing installations with which it is to be used.
- 8.3.21.7 If selective operation is required to prepare the system for use by a particular type of aircraft, then the system must provide an identification of the selected aircraft type to both the pilot and the system operator as a means of ensuring that the system has been set properly.

---

<sup>120</sup> The factors to be considered in evaluating the need for a visual docking guidance system are in particular: the number and type(s) of aircraft using the aircraft stand, weather conditions, space available on the apron and the precision required for manoeuvring into the parking position due to aircraft servicing installation, passenger loading bridges, etc. See the ICAO Aerodrome Design Manual (Doc 9157), Part 4 — Visual Aids for guidance on the selection of suitable systems

<sup>121</sup> Care is required in both the design and on-site installation of the system to ensure that reflection of sunlight, or other light in the vicinity, does not degrade the clarity and conspicuity of the visual cues provided by the system.

### Azimuth guidance unit

#### *Location*

8.3.21.8 The azimuth guidance unit must be located on or close to the extension of the stand centre line ahead of the aircraft so that its signals are visible from the cockpit of an aircraft throughout the docking manoeuvre and aligned for use at least by the pilot occupying the left seat.

#### *Characteristics*

8.3.21.9 The azimuth guidance unit must provide unambiguous left/right guidance which enables the pilot to acquire and maintain the lead-in line without over controlling.

8.3.21.10 When azimuth guidance is indicated by colour change, green must be used to identify the centre line and red for deviations from the centre line.

### Stopping position indicator

#### *Location*

8.3.21.11 The stopping position indicator must be located in conjunction with, or sufficiently close to, the azimuth guidance unit so that a pilot can observe both the azimuth and stop signals without turning the head.

8.3.21.12 The stopping position indicator must be usable at least by the pilot occupying the left seat.

#### *Characteristics*

8.3.21.13 The stopping position information provided by the indicator for a particular aircraft type must account for the anticipated range of variations in pilot eye height and/or viewing angle.

8.3.21.14 The stopping position indicator must show the stopping position for the aircraft for which guidance is being provided and must provide closing rate information to enable the pilot to gradually decelerate the aircraft to a full stop at the intended stopping position.

8.3.21.15 When stopping guidance is indicated by colour change, green must be used to show that the aircraft can proceed and red to show that the stop point has been reached except that for a short distance prior to the stop point a third colour may be used to warn that the stopping point is close.

### **8.3.22 Advanced visual docking guidance system**

#### *Application*

- 8.3.22.1 The A-VDGS must be suitable for use by all types of aircraft for which the aircraft stand is intended.
- 8.3.22.2 The A-VDGS must only be used in conditions in which its operational performance is specified<sup>122</sup>.
- 8.3.22.3 The docking guidance information provided by an A-VDGS must not conflict with that provided by a conventional visual docking guidance system on an aircraft stand if both types are provided and are in operational use. A method of indicating that the A-VDGS is not in operational use or unserviceable must be provided.

#### *Location*

- 8.3.22.4 The A-VDGS must be located such that unobstructed and unambiguous guidance is provided to the person responsible for<sup>123</sup>, and persons assisting, the docking of the aircraft throughout the docking manoeuvre.

#### *Characteristics*

- 8.3.22.5 The A-VDGS must provide, at minimum, the following guidance information at the appropriate stage of the docking manoeuvre:
- (a) an emergency stop indication;
  - (b) the aircraft type and model for which the guidance is provided;
  - (c) an indication of the lateral displacement of the aircraft relative to the stand centre line;
  - (d) the direction of azimuth correction needed to correct a displacement from the stand centre line;
  - (e) an indication of the distance to the stop position;
  - (f) an indication when the aircraft has reached the correct stopping position; and
  - (g) a warning indication if the aircraft goes beyond the appropriate stop position.
- 8.3.22.6 The A-VDGS must be capable of providing docking guidance information for all aircraft taxi speeds<sup>124</sup> encountered during the docking manoeuvre.

---

<sup>122</sup> The use of the A-VDGS in conditions such as weather, visibility, and background lighting both by day and night would need to be specified. Care is required in both the design and on-site installation of the system to ensure that glare, reflection of sunlight, or other light in the vicinity, does not degrade the clarity and conspicuity of the visual cues provided by the system.

<sup>123</sup> Usually the pilot-in-command is responsible for the docking of the aircraft. However, in some circumstances, another person could be responsible, and this person may be the driver of a vehicle that is towing the aircraft.

<sup>124</sup> See the ICAO Aerodrome Design Manual (Doc 9157), Part 4, for an indication of the maximum aircraft speeds relative to distance to the stopping position

- 8.3.22.7 The time taken from the determination of the lateral displacement to its display must not result in a deviation of the aircraft, when operated in normal conditions, from the stand centreline greater than 1m.
- 8.3.22.8 Symbols and graphics<sup>125</sup> used to depict guidance information must be intuitively representative of the type of information provided.
- 8.3.22.9 Information on the lateral displacement<sup>126</sup> of the aircraft relative to the stand centre line must be provided at least 25m prior to the stop position.
- 8.3.22.10 Continuous closure distance and closure rate must be provided from at least 15m prior to the stop position.
- 8.3.22.11 Throughout the docking manoeuvre, an appropriate means must be provided on the A-VDGS to indicate the need to bring the aircraft to an immediate halt. In such an event, which includes a failure of the A-VDGS, no other information must be displayed.
- 8.3.22.12 Provision to initiate an immediate halt to the docking procedure must be made available to personnel responsible for the operational safety of the stand.

### **8.3.23 Aircraft stand manoeuvring guidance lights**

#### *Location*

- 8.3.23.1 Aircraft stand manoeuvring guidance lights must be collocated with the aircraft stand markings.

#### *Characteristics*

- 8.3.23.2 Aircraft stand manoeuvring guidance lights, other than those indicating a stop position, must be fixed yellow lights, visible throughout the segments within which they are intended to provide guidance.
- 8.3.23.3 The lights indicating a stop position must be fixed, unidirectional lights, showing red.

### **8.3.24 Road-holding position light**

#### *Application*

- 8.3.24.1 A road-holding position light must be provided at each road-holding position serving a runway when it is intended that the runway will be used in runway visual range conditions less than a value of 350m.

---

<sup>125</sup> The use of colour would need to be appropriate and need to follow signal convention, i.e. red, yellow and green mean hazard, caution and normal/correct conditions, respectively. The effects of colour contrasts would also need to be considered.

<sup>126</sup> The indication of the distance of the aircraft from the stop position may be colour-coded and presented at a rate and distance proportional to the actual closure rate and distance of the aircraft approaching the stop point

*Location*

8.3.24.2 A road-holding position light<sup>127</sup> must be located adjacent to the holding position marking 1.5m ( $\pm$  0.5m) from both edges of the road.

*Characteristics*

8.3.24.3 The road-holding position light must comprise:

- (a) a controllable red (stop)/green (go) traffic light<sup>128</sup>; or
- (b) a flashing-red light.

8.3.24.4 The road-holding position light beam must be unidirectional and aligned so as to be visible to the driver of a vehicle approaching the holding position.

8.3.24.5 The intensity of the light beam must be adequate for the conditions of visibility and ambient light in which the use of the holding position is intended but must not dazzle the driver.

8.3.24.6 The flash frequency of the flashing-red light must be between 30 and 60 per minute.

**8.3.25 No-entry bar**

*Characteristics*

8.3.25.1 The intensity in red light and beam spreads of no-entry bar lights must be in accordance with the specifications in Appendix 3, Figures A3-12 through A3-16, as appropriate.

8.3.25.2 Taxiway centre line lights installed beyond the no-entry bar, looking in the direction of the runway, must not be visible when viewed from the taxiway.

**8.3.26 Runway status lights**

*Location*

8.3.26.1 Where provided, runway entrance lights (RELs) must be offset 0.6 m from the taxiway centre line on the opposite side to the taxiway centre line lights and begin 0.6 m before the runway-holding position<sup>129</sup> extending to the edge of the runway. An additional single light must be placed on the runway 0.6 m from the runway centre line and aligned with the last two taxiway RELs.

8.3.26.2 RELs must consist of at least five light units and must be spaced at a minimum of 3.8m and a maximum of 15.2m longitudinally, depending upon the taxiway length involved, except for a single light installed near the runway centre line.

---

<sup>127</sup> See paragraph 12.5 for the mass and height limitations and frangibility requirements of navigation aids located on runway strips.

<sup>128</sup> It is intended that the lights specified in sub-paragraph a) be controlled by the air traffic services.

<sup>129</sup> Where two or more runway-holding positions are provided, the runway-holding position referred is that closest to the runway.



- 8.3.26.3 Where provided, take-off hold lights (THLs)<sup>130</sup> must be offset 1.8m on each side of the runway centre line lights and extend, in pairs, starting at a point 115m from the beginning of the runway and, thereafter, every 30m for at least 450m.

*Characteristics*

- 8.3.26.4 Where provided, RELs must consist of a single line of fixed in pavement lights showing red in the direction of aircraft approaching the runway.
- 8.3.26.5 RELs must illuminate as an array at each taxiway/runway intersection where they are installed less than 2 seconds after the system determines a warning is needed.
- 8.3.26.6 Intensity and beam spread of runway entrance lights must be in accordance with the specifications of Appendix 3, Figures A3-12 and A3-14<sup>131</sup>.
- 8.3.26.7 Where provided, THLs must consist of two rows of fixed in pavement lights showing red facing the aircraft taking off.
- 8.3.26.8 THLs must illuminate as an array on the runway less than 2 seconds after the system determines a warning is needed.
- 8.3.26.9 Intensity and beam spread of THLs must be in accordance with the specifications of Appendix 3, Figure A3-26.

## **8.4 Signs**

### **8.4.1 General**

*Application*

- 8.4.1.1 Signs<sup>132</sup> must be provided to convey a mandatory instruction, information on a specific location or destination on a movement area or to provide other information to meet the requirements of the surface movement guidance and control systems<sup>133</sup>.

*Characteristics*

- 8.4.1.2 Signs must be frangible. Those located near a runway or taxiway must be sufficiently low to preserve clearance for propellers and the engine pods of jet aircraft. The installed height of the sign must not exceed the dimension shown in the appropriate column of Table 8-4.
- 8.4.1.3 Signs must be rectangular, as shown in Figures 8-24 and 8-25 with the longer side horizontal.

---

<sup>130</sup> Additional THLs may be similarly provided at the starting point of the take-off roll.

<sup>131</sup> Consideration for reduced beam width may be required for some runway entrance lights at acute angled runway/taxiway intersections to ensure the RELs are not visible to aircraft on the runway.

<sup>132</sup> Signs can be either fixed message signs or variable message signs. Guidance on signs is contained in the ICAO Aerodrome Design Manual (Doc 9157), Part 4.

<sup>133</sup> See paragraph 8.2.16 for specifications on information marking

- 8.4.1.4 The only signs on the movement area utilizing red must be mandatory instruction signs.
- 8.4.1.5 The inscriptions on a sign must be in accordance with the provisions of Appendix 5.
- 8.4.1.6 Signs must be illuminated in accordance with the provisions of Appendix 5 when intended for use:
  - (a) in runway visual range conditions less than a value of 800m; or
  - (b) at night in association with instrument runways; or
  - (c) at night in association with non-instrument runways where the code number is 3 or 4.

Table 8-4 – Location distances for taxiing guidance signs including runway exit signs

Code number	Sign height (mm)			Perpendicular distance from defined taxiway pavement edge to near side of sign	Perpendicular distance from defined runway pavement edge to near side of sign
	Legend	Face (min.)	Installed (max.)		
1 or 2	200	300	700	5-11 m	3-10 m
1 or 2	300	450	900	5-11 m	3-10 m
3 or 4	300	450	900	11-21 m	8-15 m
3 or 4	400	600	1 100	11-21 m	8-15 m

- 8.4.1.7 Signs must be retroreflective and/or illuminated in accordance with the provisions of Appendix 5 when intended for use at night in association with non-instrument runways where the code number is 1 or 2.
- 8.4.1.8 A variable message sign must show a blank face when not in use.
- 8.4.1.9 In case of failure, a variable message sign must not provide information that could lead to unsafe action from a pilot or a vehicle driver.

#### 8.4.2 Mandatory instruction signs

##### *Application*

- 8.4.2.1 A mandatory instruction sign<sup>134</sup> must be provided to identify a location beyond which an aircraft taxiing or vehicle must not proceed unless authorised by the aerodrome control tower.

<sup>134</sup> See Figure 8-24 for pictorial representation of mandatory instruction sign

- 8.4.2.2 Mandatory instruction signs must include runway designation signs, category I, II or III holding position signs, runway-holding position signs<sup>135</sup>, road-holding position signs and NO ENTRY signs.
- 8.4.2.3 A pattern "A" runway-holding position marking must be supplemented at a taxiway/runway intersection or a runway/runway intersection with a runway designation sign.
- 8.4.2.4 A pattern "B" runway-holding position marking must be supplemented with a category I, II or III holding position sign.
- 8.4.2.5 A pattern "A" runway-holding position marking at a runway-holding position established in accordance with paragraph 6.12.2 must be supplemented with a runway-holding position sign.
- 8.4.2.6 A NO ENTRY sign must be provided when entry into an area is prohibited.

---

<sup>135</sup> See paragraph 8.4.6 for specifications on road-holding position signs.









Runway designation of a runway extremity (Example)		Indicates a runway-holding position at a runway extremity
Runway designation of both extremities of a runway (Example)		Indicates a runway-holding position located at taxiway/runway intersection other than runway extremity
Category I hold position (Example)		Indicates a category I runway-holding position at the threshold of runway 25
Category II hold position (Example)		Indicates a category II runway-holding position at the threshold of runway 25
Category III hold position (Example)		Indicates a category III runway-holding position at the threshold of runway 25
Category II and III hold position (Example)		Indicates a joint category II and III runway-holding position at the threshold of runway 25
Category I, II and III hold position (Example)		Indicates a joint category I, II and III runway-holding position at the threshold of runway 25
NO ENTRY		Indicates that entry to an area is prohibited
Runway-holding position (Example)		Indicates a runway-holding position (in accordance with 6.12.2)

Figure 8-24. Mandatory instruction signs

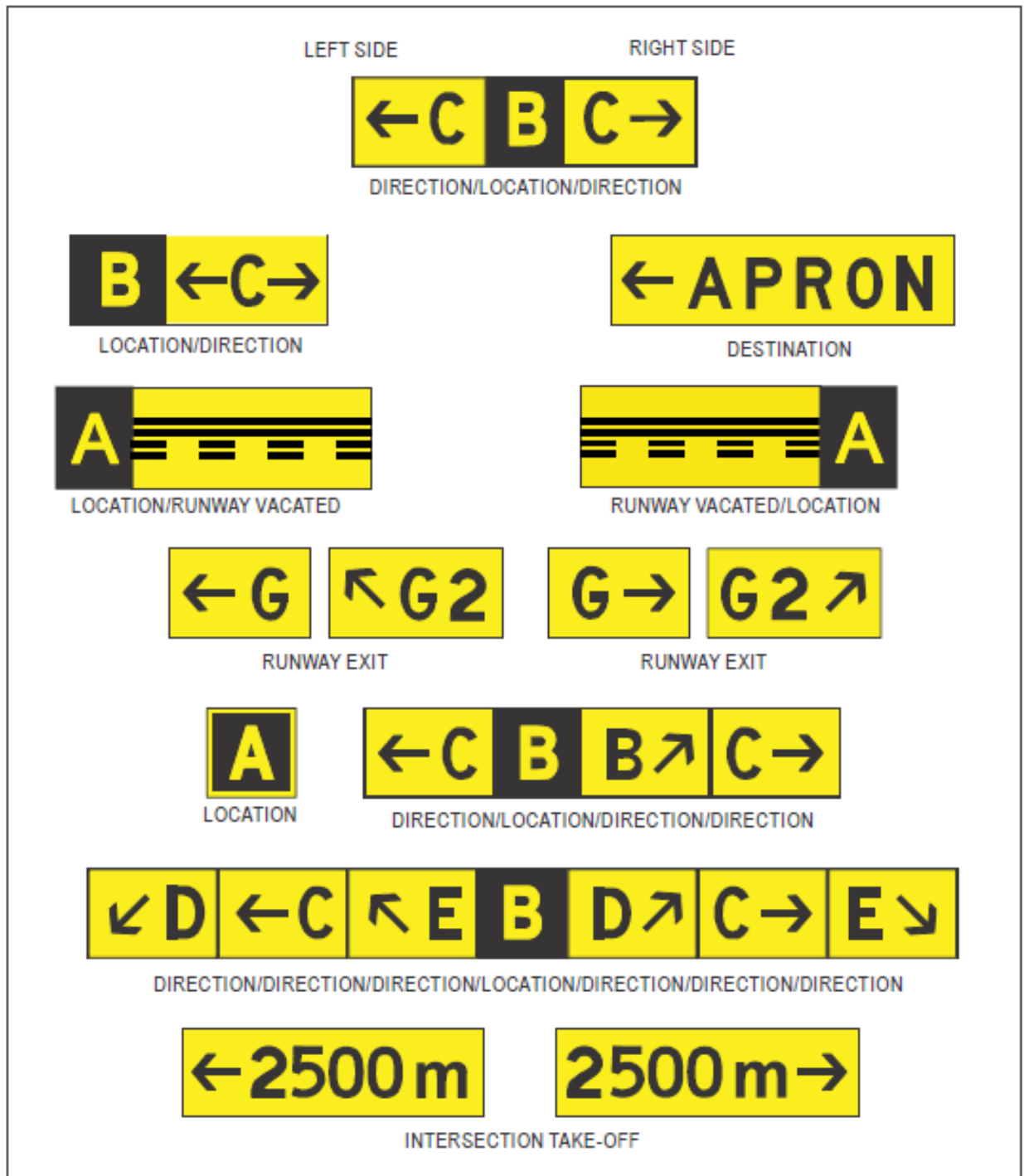
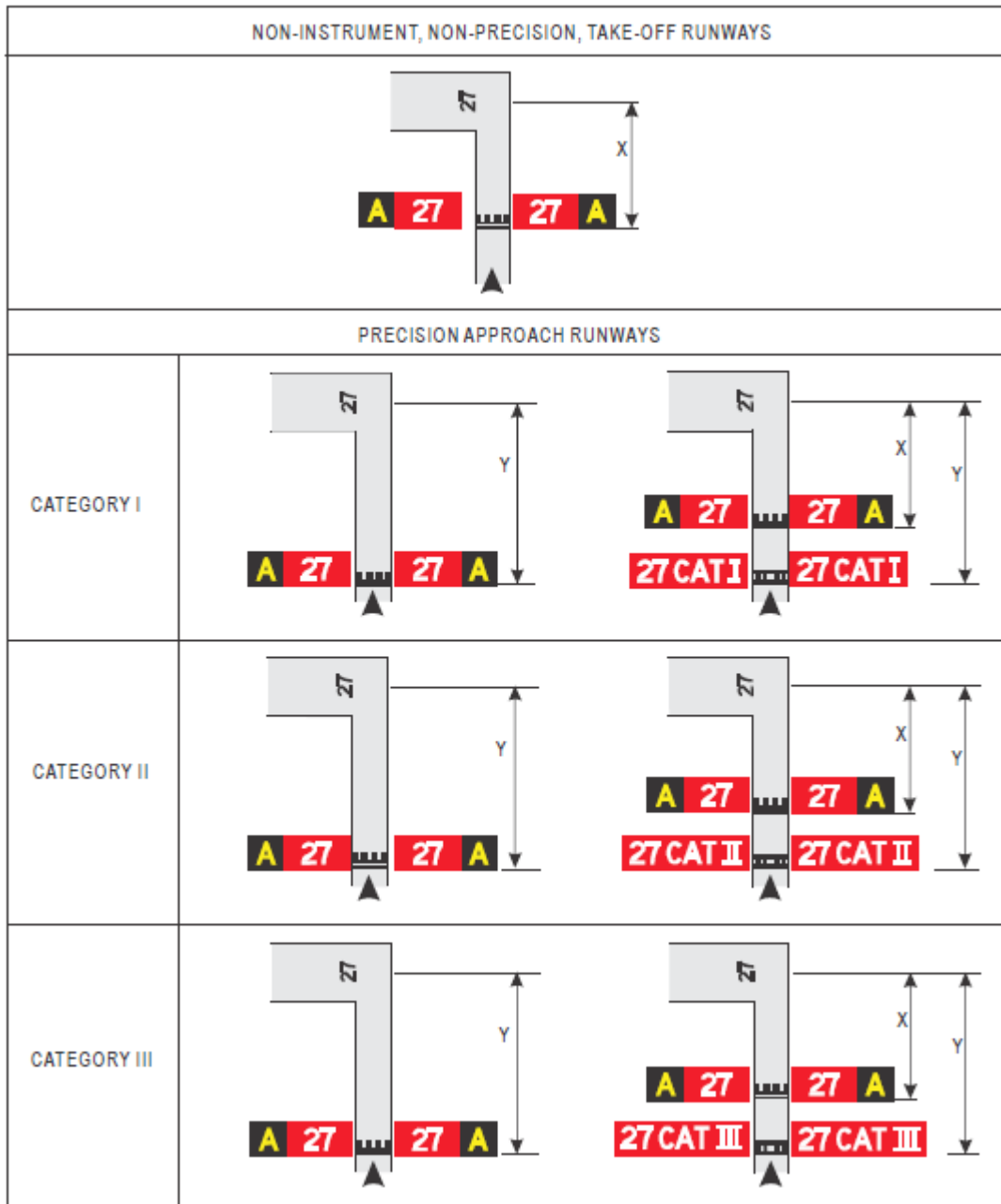

Figure 8-25. Information signs



Note.— Distance X is established in accordance with Table 6-2. Distance Y is established at the edge of the ILS/MLS critical/sensitive area.

Figure 8-26. Examples of sign positions at taxiway/runway intersections

*Location*

- 8.4.2.7 A runway designation sign at a taxiway/runway intersection or a runway/runway intersection must be located on each side of the runway-holding position marking facing the direction of approach to the runway. (See Figure 8-26).
- 8.4.2.8 A category I, II or III holding position sign must be located on each side of the runway-holding position marking facing the direction of the approach to the critical area.

- 8.4.2.9 A NO ENTRY sign must be located at the beginning of the area to which entrance is prohibited on each side of the taxiway as viewed by the pilot.
- 8.4.2.10 A runway-holding position sign must be located on each side of the runway-holding position established in accordance with paragraph 6.12.2, facing the approach to the obstacle limitation surface or ILS/MLS critical/sensitive area, as appropriate.

#### *Characteristics*

- 8.4.2.11 A mandatory instruction sign must consist of an inscription in white on a red background.
- 8.4.2.12 The inscription on a runway designation sign must consist of the runway designations of the intersecting runway properly oriented with respect to the viewing position of the sign, except that a runway designation sign installed in the vicinity of a runway extremity may show the runway designation of the concerned runway extremity only.
- 8.4.2.13 The inscription on a category I, II, III, joint II/III or joint I/II/III holding position sign must consist of the runway designator followed by CAT I, CAT II, CAT III, CAT II/III or CAT I/II/III, as appropriate.
- 8.4.2.14 The inscription on a NO ENTRY sign must be in accordance with Figure 8-24.
- 8.4.2.15 The inscription on a runway-holding position sign at a runway-holding position established in accordance with paragraph 6.12.2 must consist of the taxiway designation and a number.
- 8.4.2.16 Where installed, the inscriptions/ symbol of Figure 8-24 must be used.

### **8.4.3 Information signs**

#### *Application*

- 8.4.3.1 An information sign<sup>136</sup> must be provided where there is an operational need to identify by a sign, a specific location, or routing (direction or destination) information.
- 8.4.3.2 Information signs must include: direction signs, location signs, destination signs, runway exit signs, runway vacated signs and intersection take-off signs.
- 8.4.3.3 A runway exit sign must be provided where there is an operational need to identify a runway exit.
- 8.4.3.4 A runway vacated sign must be provided where the exit taxiway is not provided with taxiway centre line lights<sup>137</sup> and there is a need to indicate to a pilot leaving a runway the perimeter of the ILS/MLS critical/sensitive area or the lower edge of the inner transitional surface, whichever is farther from the runway centre line.

---

<sup>136</sup> See Figure 8-25 for pictorial representations of information signs

<sup>137</sup> See paragraph 8.3.14 for specifications on colour coding taxiway centre line lights.

- 8.4.3.5 A combined location and direction sign must be provided when it is intended to indicate routing information prior to a taxiway intersection.
- 8.4.3.6 A direction sign must be provided when there is an operational need to identify the designation and direction of taxiways at an intersection.
- 8.4.3.7 A location sign must be provided in conjunction with a runway designation sign except at a runway/runway intersection.
- 8.4.3.8 A location sign must be provided in conjunction with a direction sign, except that it may be omitted where an aeronautical study indicates that it is not needed.

*Location*

- 8.4.3.9 Except as specified in paragraph 8.4.3.11, information signs must, wherever practicable, be located on the left-hand side of the taxiway in accordance with Table 8-4.
- 8.4.3.10 At a taxiway intersection, information signs must be located prior to the intersection and in line with the intermediate holding position marking<sup>138</sup>. Where there is no intermediate holding position marking, the signs must be installed at least 60m from the centre line of the intersecting taxiway where the code number is 3 or 4 and at least 40m where the code number is 1 or 2.
- 8.4.3.11 A runway exit sign must be located on the same side of the runway as the exit is located (i.e. left or right) and positioned in accordance with Table 8-4.
- 8.4.3.12 A runway exit sign must be located prior to the runway exit point in line with a position at least 60 m prior to the point of tangency where the code number is 3 or 4, and at least 30 m where the code number is 1 or 2.
- 8.4.3.13 A runway vacated sign must be located at least on one side of the taxiway. The distance between the sign and the centre line of a runway must be not less than the greater of the following:
  - (a) the distance between the centre line of the runway and the perimeter of the ILS/MLS critical/sensitive area; or
  - (b) the distance between the centre line of the runway and the lower edge of the inner transitional surface.
- 8.4.3.14 Where provided in conjunction with a runway vacated sign, the taxiway location sign must be positioned outboard of the runway vacated sign.
- 8.4.3.15 An intersection take-off sign must be located at the left-hand side of the entry taxiway. The distance between the sign and the centre line of the runway must be not less than 60 m where the code number is 3 or 4 and not less than 45 m where the code number is 1 or 2.
- 8.4.3.16 A taxiway location sign installed in conjunction with a runway designation sign must be positioned outboard of the runway designation sign.

---

<sup>138</sup> A location sign installed beyond a taxiway intersection may be installed on either side of a taxiway.



- 8.4.3.17 An information sign other than a location sign must not be collocated with a mandatory instruction sign.

*Characteristics*

- 8.4.3.18 An information sign other than a location sign must consist of an inscription in black on a yellow background.
- 8.4.3.19 A location sign must consist of an inscription in yellow on a black background and where it is a stand-alone sign must have a yellow border.
- 8.4.3.20 The inscription on a runway exit sign must consist of the designator of the exit taxiway and an arrow indicating the direction to follow.
- 8.4.3.21 The inscription on a runway vacated sign must depict the pattern A runway-holding position marking as shown in Figure 8-25.
- 8.4.3.22 The inscription on an intersection take-off sign must consist of a numerical message indicating the remaining take-off run available in metres plus an arrow, appropriately located and oriented, indicating the direction of the take-off as shown in Figure 8-25.
- 8.4.3.23 The inscription on a destination sign must comprise an alpha, alphanumerical or numerical message identifying the destination plus an arrow indicating the direction to proceed as shown in Figure 8-25.
- 8.4.3.24 The inscription on a direction sign must comprise an alpha or alphanumerical message identifying the taxiway(s) plus an arrow or arrows appropriately oriented as shown in Figure 8-25.
- 8.4.3.25 The inscription on a location sign must comprise the designation of the location taxiway, runway or other pavement the aircraft is on or is entering and must not contain arrows.
- 8.4.3.26 Where a location sign and direction signs are used in combination:
- (a) all direction signs related to left turns must be placed on the left side of the location sign and all direction signs related to right turns must be placed on the right side of the location sign, except that where the junction consists of one intersecting taxiway, the location sign may alternatively be placed on the left hand side;
  - (b) the direction signs must be placed such that the direction of the arrows departs increasingly from the vertical with increasing deviation of the corresponding taxiway;
  - (c) an appropriate direction sign must be placed next to the location sign where the direction of the location taxiway changes significantly beyond the intersection; and
  - (d) adjacent direction signs must be delineated by a vertical black line as shown in Figure 8-25.

- 8.4.3.27 A taxiway must be identified by a designator that is used only once on an aerodrome comprising a single letter, two letters or a combination of a letter or letters followed by a number.
- 8.4.3.28 When designating taxiways, the use of the letters I, O or X must not be used to avoid confusion with the numerals 1, 0 and closed marking.
- 8.4.3.29 The use of numbers alone on the manoeuvring area must be reserved for the designation of runways.

#### **8.4.4 VOR aerodrome check-point sign**

##### *Application*

- 8.4.4.1 When a VOR aerodrome check-point is established, it must be indicated by a VOR aerodrome check-point marking<sup>139</sup> and sign.

##### *Location*

- 8.4.4.2 A VOR aerodrome check-point sign must be located as near as possible to the check-point and so that the inscriptions are visible from the cockpit of an aircraft properly positioned on the VOR aerodrome check-point marking.

##### *Characteristics*

- 8.4.4.3 A VOR aerodrome check-point sign must consist of an inscription in black on a yellow background.

#### **8.4.5 Aerodrome identification sign**

##### *Characteristics*

- 8.4.5.1 The aerodrome identification sign must consist of the name of the aerodrome.

#### **8.4.6 Road-holding position sign**

- 8.4.6.1 A road-holding position sign must be provided at all road entrances to a runway.

##### *Location*

- 8.4.6.2 The road-holding position sign must be located 1.5 m from both edges of the road at the holding position.

##### *Characteristics*

- 8.4.6.3 A road-holding position sign must consist of an inscription in white on a red background.

---

<sup>139</sup> See paragraph 8.2.12 for VOR aerodrome -point marking

- 8.4.6.4 The inscription on a road-holding position sign<sup>140</sup> must be in English language, and include the following:
- (a) a requirement to stop; and
  - (b) where appropriate:
    - (1) a requirement to obtain ATC clearance; and
    - (2) location designator.
- 8.4.7.5 A road-holding position sign intended for night use must be retroreflective or illuminated.

## **8.5 Markers**

8.5.1 Markers must be frangible<sup>141</sup>. Those located near a runway or taxiway must be sufficiently low to preserve clearance for propellers and for the engine pods of jet aircraft.

### **8.5.2 Stopway edge markers**

#### *Characteristics*

8.5.2.1 The stopway edge markers<sup>142</sup> must be sufficiently different from any runway edge markers used to ensure that the two types of markers cannot be confused.

### **8.5.3 Taxiway edge markers**

#### *Characteristics*

8.5.3.1 A taxiway edge marker must be retroreflective blue.

8.5.3.2 Taxiway edge markers must be frangible. Their height must be sufficiently low to preserve clearance for propellers and for the engine pods of jet aircraft.

### **8.5.4 Taxiway centre line markers**

#### *Characteristics*

8.5.4.1 A taxiway centre line marker must be retroreflective green.

8.5.4.2 Taxiway centre line markers must be so designed and fitted as to withstand being run over by the wheels of an aircraft without damage either to the aircraft or to the markers themselves.

---

<sup>140</sup> Examples of road-holding position signs are contained in the ICAO Aerodrome Design Manual (Doc 9157), Part 4.

<sup>141</sup> Anchors or chains, to prevent markers which have broken from their mounting from blowing away, are sometimes used. Guidance on frangibility of markers is given in the ICAO Aerodrome Design Manual (Doc 9157), Part 6.

<sup>142</sup> Markers consisting of small vertical boards camouflaged on the reverse side, as viewed from the runway, have proved operationally acceptable.

### 8.5.5 Boundary markers

8.5.5.1 Boundary markers must be provided at an aerodrome where the landing area has no runway.

#### *Location*

8.5.5.2 Boundary markers must be spaced along the boundary of the landing area at intervals of not more than 200 m, if the type shown in Figure 8-27 is used, or approximately 90 m, if the conical type is used with a marker at any corner.

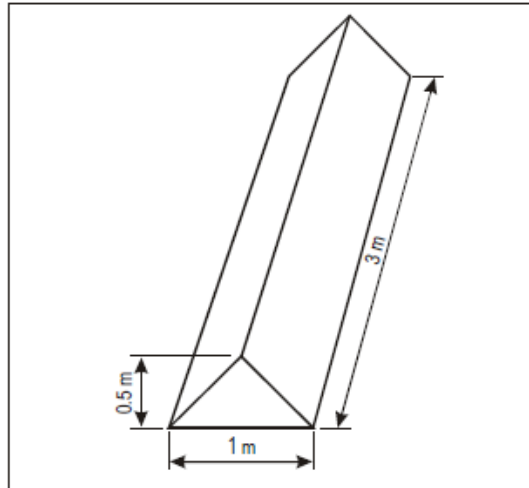

Figure 8-27. Boundary markers

## **9 Visual Aids for Denoting Obstacles**

This chapter describes the visual aids required to be provided for objects located and/or operating at and within a radius of 5km around the aerodrome.

### **9.1 Objects to be marked and/or lighted**

#### **9.1.1 Objects within the lateral boundaries of the obstacle limitation surfaces**

9.1.1.1 Vehicles and other mobile objects, excluding aircraft, on the movement area of an aerodrome are obstacles and must be marked and, if the vehicles and aerodrome are used at night or in conditions of low visibility, lighted, except that aircraft servicing equipment and vehicles used only on aprons may be exempt.

9.1.1.2 Elevated aeronautical ground lights within the movement area must be marked today you so as to be conspicuous by day. Obstacle lights must not be installed on elevated ground lights or signs in the movement area.

9.1.1.3 All obstacles within the distance specified in Table 6-1, column 11 or 12, from the centre line of a taxiway, an apron taxiway or aircraft stand taxilane must be marked and, if the taxiway, apron taxiway or aircraft stand taxilane is used at night, lighted.

9.1.1.4 A fixed obstacle that extends above a take-off climb surface within 3000m of the inner edge of the take-off climb surface must be marked and, if the runway is used at night, lighted, except that:

- (a) such marking and lighting may be omitted when the obstacle is shielded by another fixed obstacle;
- (b) the marking may be omitted when the obstacle is lighted by medium-intensity obstacle lights, Type A, by day and its height above the level of the surrounding ground does not exceed 150m;
- (c) the marking may be omitted when the obstacle is lighted by high-intensity obstacle lights by day; and
- (d) the lighting may be omitted where the obstacle is a lighthouse and an aeronautical study indicates the lighthouse light to be sufficient.

9.1.1.5 A fixed obstacle that extends above an approach surface within 3000m of the inner edge or above a transitional surface must be marked and, if the runway is used at night, lighted, except that:

- (a) such marking and lighting may be omitted when the obstacle is shielded by another fixed obstacle;
- (b) the marking may be omitted when the obstacle is lighted by medium-intensity obstacle lights, Type A, by day and its height above the level of the surrounding ground does not exceed 150m;

- (c) the marking may be omitted when the obstacle is lighted by high-intensity obstacle lights by day; and
- (d) the lighting may be omitted where the obstacle is a lighthouse and an aeronautical study indicates the lighthouse light to be sufficient.

9.1.1.6 A fixed object that extends above an obstacle protection surface must be marked and, if the runway is used at night, lighted.

## **9.2 Marking and/or lighting of objects**

### **9.2.1 General**

9.2.1.1 The presence of objects which must be lighted, as specified in paragraph 9.1, must be indicated by low-, medium- or high-intensity obstacle lights, or a combination of such lights.

9.2.1.2 Low-intensity obstacle lights, Types A, B, C, D and E, medium-intensity obstacle lights, Types A, B and C, high-intensity obstacle lights Type A and B, must be in accordance with the specifications in Table 9-1 and Appendix 2.

9.2.1.3 The number and arrangement of low-, medium- or high-intensity obstacle lights at each level to be marked must be such that the object is indicated from every angle in azimuth. Where a light is shielded in any direction by another part of the object, or by an adjacent object, additional lights must be provided on that adjacent object or the part of the object that is shielding the light, in such a way as to retain the general definition of the object to be lighted. If the shielded light does not contribute to the definition of the object to be lighted, it may be omitted.

### **9.2.2 Mobile objects**

#### *Marking*

9.2.2.1 All mobile objects to be marked must be coloured or display flags.

#### *Marking by flags*

9.2.2.2 Flags used to mark mobile objects must be displayed around, on top of, or around the highest edge of the object. Flags must not increase the hazard presented by the object they mark.

9.2.2.3 Flags used to mark mobile objects must not be less than 0.9 m on each side and must consist of a chequered pattern, each square having sides of not less than 0.3 m. The colours of the pattern must contrast each with the other and with the background against which they will be seen. Orange and white or alternatively red and white must be used, except where such colours merge with the background.

Table 9-1 – Characteristics of obstacle lights

1	2	3	4	5	6	7
Light type	Colour	Signal type/ (flash rate)	Peak intensity (cd) at given Background Luminance (b)			Light Distribution Table
			Day (Above 500 cd/m <sup>2</sup> )	Twilight (50-500 cd/m <sup>2</sup> )	Night (Below 50 cd/m <sup>2</sup> )	
Low-intensity, Type A (fixed obstacle)	Red	Fixed	N/A	N/A	10	Table 9-2
Low-intensity, Type B (fixed obstacle)	Red	Fixed	N/A	N/A	32	Table 9-2
Low-intensity, Type C (mobile obstacle)	Yellow/Blue (a)	Flashing (60-90 fpm)	N/A	40	40	Table 9-2
Low-intensity, Type D (follow-me Vehicle)	Yellow	Flashing (60-90 fpm)	N/A	200	200	Table 9-2
Low-intensity, Type E	Red	Flashing (c)	N/A	N/A	32	Table 9-2 (Type B)
Medium-intensity, Type A	White	Flashing (20-60 fpm)	20 000	20 000	2 000	Table 9-3
Medium-intensity, Type B	Red	Flashing (20-60 fpm)	N/A	N/A	2 000	Table 9-3
Medium-intensity, Type C	Red	Fixed	N/A	N/A	2 000	Table 9-3
High-intensity, Type A	White	Flashing (40-60 fpm)	200 000	20 000	2 000	Table 9-3
High-intensity, Type B	White	Flashing (40-60 fpm)	100 000	20 000	2 000	Table 9-3

a) See paragraph 9.2.2.5.

b) For flashing lights, effective intensity as determined in accordance with ICAO Aerodrome Design Manual (Doc 9157), Part 4.

c) For wind turbine application, to flash at the same rate as the lighting on the nacelle.

Table 9-2– Light distribution for low-intensity obstacle lights

	Minimum intensity (a)	Maximum intensity (a)	Vertical beam spread (f)	
			Minimum beam spread	Intensity
Type A	10 cd (b)	N/A	10°	5 cd
Type B	32 cd (b)	N/A	10°	16 cd
Type C	40 cd (b)	400 cd	12° (d)	20 cd
Type D	200 cd (c)	400 cd	N/A (e)	N/A

*Note – This table does not include recommended horizontal beam spreads. Paragraph 9.2.1.3 requires 360° coverage around an obstacle. Therefore, the number of lights needed to meet this requirement will depend on the horizontal beam spreads of each light as well as the shape of the obstacle. Thus, with narrower beam spreads, more lights will be required.*

- (a) 360° horizontal. For flashing lights, the intensity is read into effective intensity, as determined in accordance with the ICAO Aerodrome Design Manual (Doc 9157), Part 4.
- (b) Between 2 and 10° vertical. Elevation vertical angles are referenced to the horizontal when the light is levelled.
- (c) Between 2 and 20° vertical. Elevation vertical angles are referenced to the horizontal when the light is levelled.
- (d) Peak intensity should be located at approximately 2.5° vertical.
- (e) Peak intensity should be located at approximately 17° vertical.
- (f) Beam spread is defined as the angle between the horizontal plane and the directions for which the intensity exceeds that mentioned in the “intensity” column.



Table 9-3 Light distribution for medium- and high-intensity obstacle lights according to benchmark intensities of Table 9-1

Benchmark intensity	Minimum requirements					Recommendations				
	Vertical elevation angle (b)			Vertical beam spread (c)		Vertical elevation angle (b)			Vertical beam spread (c)	
	0°		-1°			0°	-1°	-10°		
	Minimum average intensity (a)	Minimum intensity (a)	Minimum intensity (a)	Minimum beam spread	Intensity (a)	Maximum intensity (a)	Maximum intensity (a)	Maximum intensity (a)	Maximum spread beam	Intensity (a)
200 000	200 000	150 000	75 000	3°	75 000	250 000	112 500	7 500	7°	75 000
100 000	100 000	75 000	37 500	3°	37 500	125 000	56 250	3 750	7°	37 500
20 000	20 000	15 000	7 500	3°	7 500	25 000	11 250	750	N/A	N/A
2 000	2 000	1 500	750	3°	750	2 500	1 125	75	N/A	N/A

*Note – This table does not include recommended horizontal beam spreads. Paragraph 9.2.1.3 requires 360° coverage around an obstacle. Therefore, the number of lights needed to meet this requirement will depend on the horizontal beam spreads of each light as well as the shape of the obstacle. Thus, with narrower beam spreads, more lights will be required.*

(a) 360° horizontal. All intensities are expressed in Candela. For flashing lights, the intensity is read into effective intensity, as determined in accordance with the ICAO Aerodrome Design Manual (Doc 9157), Part 4.

(b) Elevation vertical angles are referenced to the horizontal when the light unit is levelled.

(c) Beam spread is defined as the angle between the horizontal plane and the directions for which the intensity exceeds that mentioned in the “intensity” column.

*Note.— An extended beam spread may be necessary under specific configuration and justified by an aeronautical study.*

### Lighting

9.2.2.4 Low-intensity obstacle lights, Type C, must be displayed on vehicles and other mobile objects excluding aircraft<sup>143</sup>.

9.2.2.5 Low-intensity obstacle lights, Type C, displayed on vehicles associated with emergency or security must be flashing-blue and those displayed on other vehicles must be flashing-yellow.

9.2.2.6 Low-intensity obstacle lights, Type D, must be displayed on follow-me vehicles.

9.2.2.7 Low-intensity obstacle lights on objects with limited mobility such as aerobridges must be fixed-red, and as a minimum be in accordance with the specifications for low-intensity obstacle lights, Type A, in Table 9-1. The intensity of the lights must be sufficient to ensure conspicuity considering the intensity of the adjacent lights and the general levels of illumination against which they would normally be viewed.

<sup>143</sup> See Appendix 3 for lights to be displayed by aircraft.

### **9.2.3 Fixed objects**

#### *Marking*

- 9.2.3.1 All fixed objects to be marked must, whenever practicable, be coloured, but if this is not practicable, markers or flags must be displayed on or above them, except that objects that are sufficiently conspicuous by their shape, size or colour need not be otherwise marked.

#### *Marking by flags*

- 9.2.3.2 Flags used to mark fixed objects must be displayed around, on top of, or around the highest edge of, the object. When flags are used to mark extensive objects or groups of closely spaced objects, they must be displayed at least every 15m. Flags must not increase the hazard presented by the object they mark.
- 9.2.3.3 Flags used to mark fixed objects must not be less than 0.6m on each side.

#### *Marking by markers*

- 9.2.3.4 Markers displayed on or adjacent to objects must be located in conspicuous positions so as to retain the general definition of the object and must be recognizable in clear weather from a distance of at least 1,000m for an object to be viewed from the air and 300m for an object to be viewed from the ground in all directions in which an aircraft is likely to approach the object. The shape of markers must be distinctive to the extent necessary to ensure that they are not mistaken for markers employed to convey other information, and they must be such that the hazard presented by the object they mark is not increased.

#### *Lighting*

- 9.2.3.5 In the case of an object to be lighted, one or more low-, medium- or high intensity obstacle lights must be located as close as practicable to the top of the object<sup>144</sup>.
- 9.2.3.6 In the case of a tower or antenna structure indicated by high-intensity obstacle lights by day with an appurtenance, such as a rod or an antenna, greater than 12m where it is not practicable to locate a high-intensity obstacle light on the top of the appurtenance, such a light must be located at the highest practicable point and, if practicable, a medium-intensity obstacle light, Type A, mounted on the top.

---

<sup>144</sup> Recommendations on how a combination of low-, medium- and/or high intensity lights on obstacles should be displayed are given in Appendix 6.

- 9.2.3.7 In the case of an extensive object or of a group of closely spaced objects to be lighted that are:
- (a) penetrating a horizontal obstacle limitation surface (OLS) or located outside an OLS, the top lights must be so arranged as to at least indicate the points or edges of the object highest in relation to the obstacle limitation surface or above the ground, and so as to indicate the general definition and the extent of the objects; and
  - (b) penetrating a sloping OLS, the top lights must be so arranged as to at least indicate the points or edges of the object highest in relation to the OLS, and so as to indicate the general definition and the extent of the objects. If two or more edges are of the same height, the edge nearest the landing area must be marked.
- 9.2.3.8 Where lights are applied to display the general definition of an extensive object or a group of closely spaced objects, and
- (a) low-intensity lights are used, they must be spaced at longitudinal intervals not exceeding 45m; and
  - (b) medium-intensity lights are used, they must be spaced at longitudinal intervals not exceeding 900m.
- 9.2.3.9 High-intensity obstacle lights, Type A, and medium-intensity obstacle lights, Types A and B located on an object must flash simultaneously.

*Lighting of objects with a height 45 m to a height less than 150 m above ground level*

- 9.2.3.10 Where an object is indicated by medium-intensity obstacle lights, Type A, and the top of the object is more than 105 m above the level of the surrounding ground or the elevation of tops of nearby buildings (when the object to be marked is surrounded by buildings), additional lights must be provided at intermediate levels. These additional intermediate lights must be spaced as equally as practicable, between the top lights and ground level or the level of tops of nearby buildings, as appropriate, with the spacing not exceeding 105 m.
- 9.2.3.11 Where an object is indicated by medium-intensity obstacle lights, Type B, and the top of the object is more than 45 m above the level of the surrounding ground or the elevation of tops of nearby buildings (when the object to be marked is surrounded by buildings), additional lights must be provided at intermediate levels. These additional intermediate lights must be alternately low-intensity obstacle lights, Type B, and medium-intensity obstacle lights, Type B, and must be spaced as equally as practicable between the top lights and ground level or the level of tops of nearby buildings, as appropriate, with the spacing not exceeding 52 m.
- 9.2.3.12 Where an object is indicated by medium-intensity obstacle lights, Type C, and the top of the object is more than 45m above the level of the surrounding ground or the elevation of tops of nearby buildings (when the object to be marked is surrounded by buildings), additional lights must be provided at intermediate levels. These additional intermediate lights must be spaced as equally as practicable, between the top lights and ground level or the level of tops of nearby buildings, as appropriate, with the spacing not exceeding 52m.

- 9.2.3.13 Where high-intensity obstacle lights, Type A, are used, they must be spaced at uniform intervals not exceeding 105m between the ground level and the top light(s) specified in paragraph 9.2.3.5, except that where an object to be marked is surrounded by buildings, the elevation of the tops of the buildings may be used as the equivalent of the ground level when determining the number of light levels.

*Lighting of objects with a height 150 m or more above ground level*

- 9.2.3.14 Where high-intensity obstacle lights, Type A, are used, they must be spaced at uniform intervals not exceeding 105 m between the ground level and the top light(s) specified in paragraph 9.2.3.5, except that where an object to be marked is surrounded by buildings, the elevation of the tops of the buildings may be used as the equivalent of the ground level when determining the number of light levels.
- 9.2.3.15 Where an object is indicated by medium-intensity obstacle lights, Type A, additional lights must be provided at intermediate levels. These additional intermediate lights must be spaced as equally as practicable, between the top lights and ground level or the level of tops of nearby buildings, as appropriate, with the spacing not exceeding 105m.
- 9.2.3.16 Where an object is indicated by medium-intensity obstacle lights, Type B, additional lights must be provided at intermediate levels. These additional intermediate lights must be alternately low-intensity obstacle lights, Type B, and medium-intensity obstacle lights, Type B, and must be spaced as equally as practicable between the top lights and ground level or the level of tops of nearby buildings, as appropriate, with the spacing not exceeding 52m.
- 9.2.3.17 Where an object is indicated by medium-intensity obstacle lights, Type C, additional lights must be provided at intermediate levels. These additional intermediate lights must be spaced as equally as practicable, between the top lights and ground level or the level of tops of nearby buildings, as appropriate, with the spacing not exceeding 52m.

**9.2.4 Wind turbines**

- 9.2.4.1 A wind turbine must be marked and/or lighted if it is determined to be an obstacle<sup>145</sup>.

**9.2.5 Overhead wires, cables, etc., and supporting towers**

*Marking by markers*

- 9.2.5.1 Markers displayed on or adjacent to objects must be located in conspicuous positions so as to retain the general definition of the object and must be recognizable in clear weather from a distance of at least 1,000m for an object to be viewed from the air and 300m for an object to be viewed from the ground in all directions in which an aircraft is likely to approach the object. The shape of markers must be distinctive to the extent necessary to ensure that they are not mistaken for markers employed to convey other information, and they must be such that the hazard presented by the object they mark is not increased.

---

<sup>145</sup> Additional lighting or markings may be provided where deemed necessary.

*Lighting*

- 9.2.5.2 Where high-intensity obstacle lights, Type B, are used, they must be located at three levels<sup>146</sup>:
- at the top of the tower;
  - at the lowest level of the catenary of the wires or cables; and
  - at approximately midway between these two levels.

---

<sup>146</sup> In some cases, this may require locating the lights off the tower.

## **10 Visual Aids for Denoting Restricted Use Areas**

### **10.1 Closed runways and taxiways, or parts thereof**

#### *Application*

- 10.1.1 A closed marking must be displayed on a runway or taxiway, or portion thereof, which is permanently closed to the use of all aircraft.

#### *Location*

- 10.1.2 On a runway a closed marking must be placed at each end of the runway, or portion thereof, declared closed, and additional markings must be so placed that the maximum interval between markings does not exceed 300 m. On a taxiway a closed marking must be placed at least at each end of the taxiway or portion thereof closed.

#### *Characteristics*

- 10.1.3 The closed marking must be of the form and proportions as detailed in Figure 10-1, Illustration a), when displayed on a runway, and must be of the form and proportions as detailed in Figure 10-1, Illustration b), when displayed on a taxiway. The marking must be white when displayed on a runway and must be yellow when displayed on a taxiway<sup>147</sup>.
- 10.1.4 When a runway or taxiway or portion thereof is permanently closed, all normal runway and taxiway markings must be obliterated.
- 10.1.5 Lighting on a closed runway or taxiway or portion thereof must not be operated, except as required for maintenance purposes.
- 10.1.6 In addition to closed markings, when the runway or taxiway or portion thereof closed is intercepted by a usable runway or taxiway which is used at night, unserviceability lights must be placed across the entrance to the closed area at intervals not exceeding 3m (See paragraph 10.4.4)

---

<sup>147</sup> When an area is temporarily closed, frangible barriers or markings utilizing materials other than paint or other suitable means may be used to identify the closed area. Procedures pertaining to the planning, coordination, monitoring and safety management of works in progress on the movement area are specified in the ICAO PANS-Aerodromes (Doc 9981).

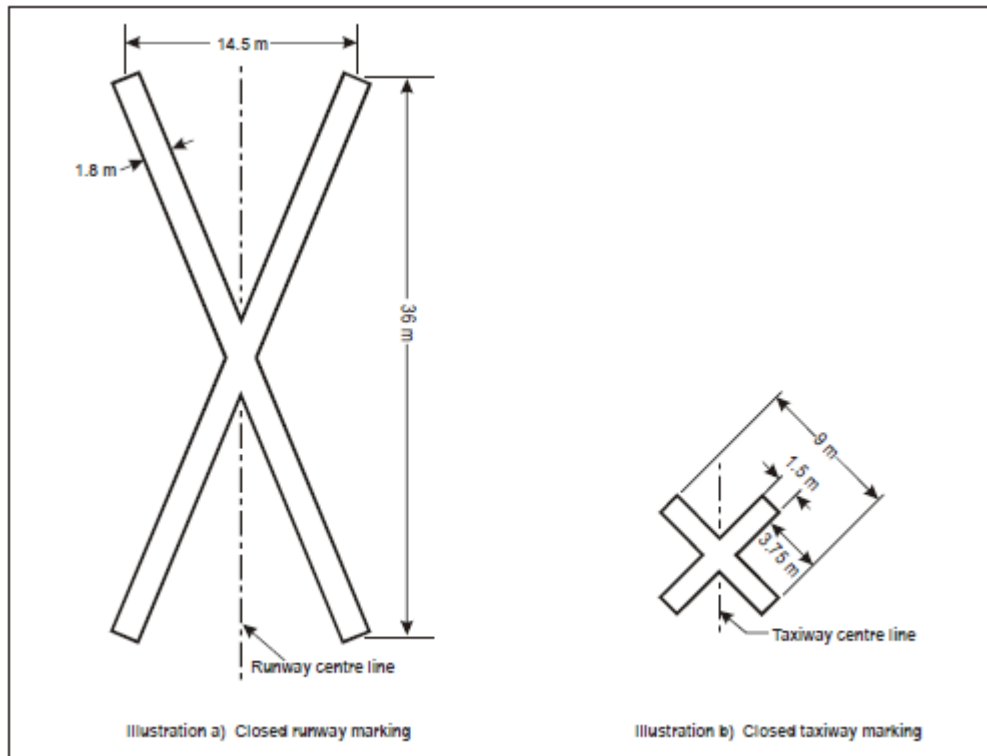

Figure 10-1 - Closed runway and taxiway markings

## 10.2 Non-load-bearing surfaces

### *Application*

- 10.2.1 Shoulders for taxiways, runway turn pads, holding bays and aprons and other non-load-bearing surfaces, which cannot readily be distinguished from load-bearing surfaces and which, if used by aircraft, might result in damage to the aircraft must have the boundary between such areas and the load-bearing surface marked by a taxi side stripe marking.

### *Location*

- 10.2.2 A taxi side stripe marking must be placed along the edge of the load-bearing pavement, with the outer edge of the marking approximately on the edge of the load-bearing pavement.

### *Characteristics*

- 10.2.3 A taxi side stripe marking must consist of a pair of solid lines, each 15cm wide and spaced 15cm apart and the same colour as the taxiway centre line marking<sup>148</sup>.

<sup>148</sup> Guidance on providing additional transverse stripes at an intersection or a small area on the apron is given in the ICAO Aerodrome Design Manual (Doc 9157), Part 4.

### 10.3 Pre-threshold area

#### Application

- 10.3.1 When the surface before a threshold is paved and exceeds 60m in length and is not suitable for normal use by aircraft, the entire length before the threshold must be marked with a chevron marking.

#### Location

- 10.3.2 A chevron marking must point in the direction of the runway and be placed as shown in Figure 10-2.

#### Characteristics

- 10.3.3 A chevron marking must be of conspicuous colour and contrast with the colour used for the runway markings; it should preferably be yellow. It must have an over-all width of at least 0.9 m.

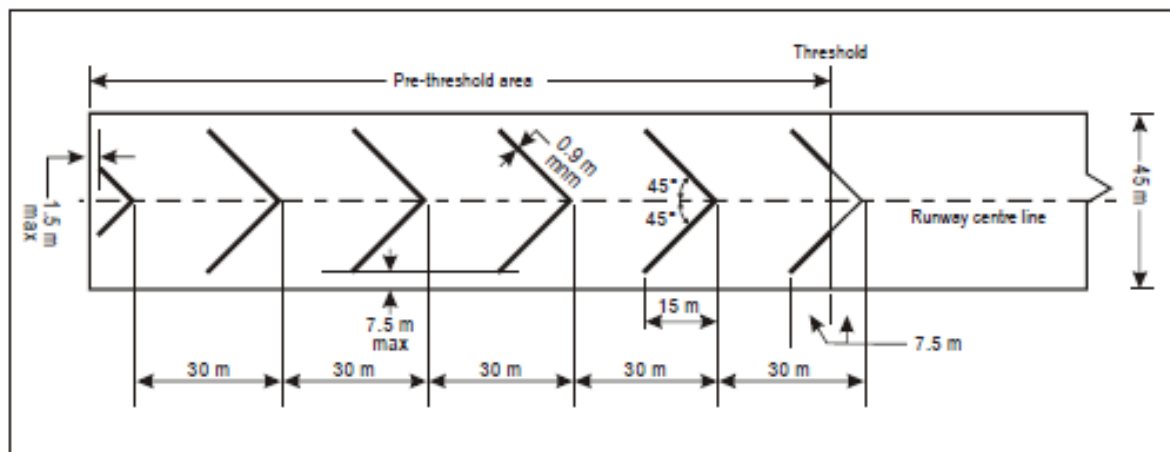

Figure 10-2. Pre-threshold marking

### 10.4 Unserviceable areas

#### Application

- 10.4.1 Unserviceability markers must be displayed wherever any portion of a taxiway, apron or holding bay is unfit for the movement of aircraft but it is still possible for aircraft to bypass the area safely. Unserviceability markers must also be displayed at the entrances to a permanently or temporarily closed runway or taxiway, or part thereof. On a movement area used at night, unserviceability lights must be used<sup>149</sup>.

<sup>149</sup> Unserviceability markers and lights are used to guide aircraft to bypass a portion of a taxiway, apron or holding bay that is unfit for normal movement are intended for such purposes as warning pilots of a hole in a taxiway or apron pavement or outlining a portion of pavement, such as on an apron, that is under repair. They are not suitable for use when a portion of a runway becomes unserviceable, nor on a taxiway when a major portion of the width becomes unserviceable. In such instances, the runway or taxiway is normally closed. Procedures pertaining to the planning, coordination, monitoring and safety management of works in progress on the movement area are specified in the ICAO PANS-Aerodromes (Doc 9981).



*Location*

10.4.2 Unserviceability markers and lights<sup>150</sup> must be placed at intervals sufficiently close so as to delineate the unserviceable area.

*Characteristics of unserviceability markers*

10.4.3 Unserviceability markers must consist of conspicuous upstanding devices such as flags, cones or marker boards.

*Characteristics of unserviceability lights*

10.4.4 An unserviceability light must consist of a red fixed light. The light must have an intensity sufficient to ensure conspicuity considering the intensity of the adjacent lights and the general level of illumination against which it would normally be viewed. In no case must the intensity be less than 10 cd of red light.

*Characteristics of unserviceability flags*

10.4.5 An unserviceability flag must be at least 0.5 m square and red, orange or yellow or any one of these colours in combination with white.

---

<sup>150</sup> Guidance on the location of unserviceability lights is given in ICAO Annex 14 Vol. I, Attachment A, Section 13.

## **11 Electrical Systems**

### **11.1 Electrical power supply systems for air navigation facilities**

- 11.1.1 Adequate primary power supply must be available at aerodromes for the safe functioning of air navigation facilities.
- 11.1.2 The design and provision of electrical power systems for aerodrome visual and radio navigation aids must be such that an equipment failure will not leave the pilot with inadequate visual and non-visual guidance or misleading information<sup>151</sup>.
- 11.1.3 Electric power supply connections to those facilities for which secondary power is required must be so arranged that the facilities are automatically connected to the secondary power supply on failure of the primary source of power.
- 11.1.4 The time interval between failure of the primary source of power and the complete restoration of the services required by paragraph 11.1.10 must be as short as practicable, except that for visual aids associated with non-precision, precision approach or take-off runways the requirements of Table 11-1 for maximum switch-over times must apply.
- 11.1.5 The electric power supply connections to those facilities for which secondary power is required must be so arranged that the facilities are capable of meeting the requirements of Table 11-1 for maximum switch-over times as defined in Appendix 1.

---

<sup>151</sup> The design and installation of the electrical systems need to take into consideration factors that can lead to malfunction, such as electromagnetic disturbances, line losses, power quality, etc. Additional guidance is given in the ICAO Aerodrome Design Manual (Doc 9157), Part 5.

Table 11-1 - Secondary power supply requirements

(See Paragraph 11.1.4)

Runway	Lighting aids requiring power	Maximum switch-over time
Non-instrument	Visual approach slope indicators <sup>a</sup> Runway edge <sup>b</sup> Runway threshold <sup>b</sup> Runway end <sup>b</sup> Obstacle <sup>a</sup>	See 11.1.4 and 11.1.9
Non-precision approach	Approach lighting system Visual approach slope indicators <sup>a, d</sup> Runway edge <sup>d</sup> Runway threshold <sup>d</sup> Runway end Obstacle <sup>a</sup>	15 seconds 15 seconds 15 seconds 15 seconds 15 seconds 15 seconds
Precision approach category I	Approach lighting system Runway edge <sup>d</sup> Visual approach slope indicators <sup>a, d</sup> Runway threshold <sup>d</sup> Runway end Essential taxiway <sup>a</sup> Obstacle <sup>a</sup>	15 seconds 15 seconds 15 seconds 15 seconds 15 seconds 15 seconds 15 seconds
Precision approach category II/III	Inner 300 m of the approach lighting system Other parts of the approach lighting system Obstacle <sup>a</sup> Runway edge Runway threshold Runway end Runway centre line Runway touchdown zone All stop bars Essential taxiway	1 second 15 seconds 15 seconds 15 seconds 1 second 1 second 1 second 1 second 1 second 1 second 15 seconds
Runway meant for takeoff in runway visual range conditions less than a value of 800 m.	Runway edge Runway end Runway centre line All stop bars Essential taxiway <sup>a</sup> Obstacle <sup>a</sup>	15 seconds <sup>c</sup> 1 second 1 second 1 second 15 seconds 15 seconds

<sup>a</sup> Supplied with secondary power when their operation is essential to the safety of flight operation.

<sup>b</sup> See guidance regarding the use of emergency lighting.

<sup>c</sup> One second where no runway centre line lights are provided.

<sup>d</sup> One second where approaches are over hazardous or precipitous terrain.

### Visual aids

- 11.1.6 For a precision approach runway, a secondary power supply capable of meeting the requirements of Table 11-1 for the appropriate category of precision approach runway must be provided. Electric power supply connections to those facilities for which secondary power is required must be so arranged that the facilities are automatically connected to the secondary power supply on failure of the primary source of power.

- 11.1.7 For a runway meant for take-off in runway visual range conditions less than a value of 800 m, a secondary power supply capable of meeting the relevant requirements of Table 11-1 must be provided.
- 11.1.8 At an aerodrome where the primary runway is a non-precision approach runway, a secondary power supply capable of meeting the requirements of Table 11-1 must be provided except that a secondary power supply for visual aids need not be provided for more than one non-precision approach runway.
- 11.1.9 At an aerodrome where the primary runway is a non-instrument runway, a secondary power supply capable of meeting the requirements of paragraph 11.1.4 must be provided, except that a secondary power supply for visual aids need not be provided when an emergency lighting system is provided and capable of being deployed in 15 minutes.
- 11.1.10 The following aerodrome facilities must be provided with secondary power<sup>152</sup> supply capable of supplying power when there is a failure of primary power supply:
- (a) the signalling lamp and the minimum lighting necessary to enable air traffic services personnel to carry out their duties<sup>153</sup>,
  - (b) all obstacle lights which are essential to ensure the safe operation of aircraft;
  - (c) approach, runway and taxiway lighting as specified in paragraphs 11.1.6 to 11.1.9;
  - (d) meteorological equipment;
  - (e) essential security lighting, if provided in accordance with paragraph 12.7;
  - (f) essential equipment and facilities for the aerodrome responding emergency agencies; and
  - (g) floodlighting on a designated isolated aircraft parking position if provided; and
  - (h) illumination of apron areas over which passengers may walk.
- 11.1.11 Requirements for a secondary power supply must be met by either of the following:
- independent public power, which is a source of power supplying the aerodrome service from a substation other than the normal substation through a transmission line following a route different from the normal power supply route and such that the possibility of a simultaneous failure of the normal and independent public power supplies is extremely remote; or
  - standby power unit(s), which are engine generators, batteries, etc., from which electric power can be obtained.

---

<sup>152</sup> Specifications for secondary power supply for radio navigation aids and ground elements of communications systems are given in ICAO Annex 10, Volume I, Chapter 2

<sup>153</sup> The requirement for minimum lighting may be met by other than electrical means.

## **11.2 System design**

- 11.2.1 For a runway meant for use in runway visual range conditions less than a value of 550 m, the electrical systems for the power supply, lighting and control of the lighting systems included in Table 11-1 must be so designed that an equipment failure will not leave the pilot with inadequate visual guidance or misleading information<sup>154</sup>.
- 11.2.2 Where the secondary power supply of an aerodrome is provided by the use of duplicate feeders, such supplies must be physically and electrically separate so as to ensure the required level of availability and independence.
- 11.2.3 Where a runway forming part of a standard taxi-route is provided with runway lighting and taxiway lighting, the lighting systems must be interlocked to preclude the possibility of simultaneous operation of both forms of lighting.

## **11.3 Monitoring**

- 11.3.1 A system of monitoring<sup>155</sup> must be employed to indicate the operational status of the lighting systems.
- 11.3.2 Where lighting systems are used for aircraft control purposes, such systems must be monitored automatically so as to provide an indication of any fault which may affect the control functions. This information must be automatically relayed to the air traffic services unit.
- 11.3.3 Where a change in the operational status of lights has occurred, an indication must be provided within two seconds for a stop bar at a runway-holding position and within five seconds for all other types of visual aids.
- 11.3.4 For a runway meant for use in runway visual range conditions less than a value of 550m, the lighting systems detailed in Table 11-1 must be monitored automatically so as to provide an indication when the serviceability level of any element falls below the minimum serviceability level specified in paragraphs 13.4.4 to 13.4.8, as appropriate. This information must be automatically relayed to the maintenance crew.

---

<sup>154</sup> Guidance on means of providing this protection is given in the ICAO Aerodrome Design Manual (Doc 9157), Part 5

<sup>155</sup> Guidance is given in the ICAO Aerodrome Design Manual (Doc 9157), Part 5.

## 12 Aerodrome Operational Services, Equipment and Installations

### 12.1 Rescue and firefighting

*Level of protection to be provided*

- 12.1.1 The level of protection provided at an aerodrome for rescue and firefighting must be appropriate to the aerodrome category determined using the principles in paragraphs 12.1.3 and 12.1.4.
- 12.1.2 The aerodrome category must be determined from Table 12-1 and must be based on the longest aeroplanes normally using the aerodrome and their fuselage width<sup>156</sup>.
- 12.1.3 If, after selecting the category appropriate to the longest aeroplane's overall length, that aeroplane's fuselage width is greater than the maximum width in Table 12-1, column 3 for that category, then the category for that aeroplane must actually be one category higher<sup>157</sup>.

Table 12-1 - Aerodrome category for rescue and fire fighting

Aerodrome Category	Aeroplane overall length	Maximum fuselage width
(1)	(2)	(3)
1	0 m up to but not including 9 m	2 m
2	9 m up to but not including 12 m	2 m
3	12 m up to but not including 18 m	3 m
4	18 m up to but not including 24 m	4 m
5	24 m up to but not including 28 m	4 m
6	28 m up to but not including 39 m	5 m
7	39 m up to but not including 49 m	5 m
8	49 m up to but not including 61 m	7 m
9	61 m up to but not including 76 m	7 m
10	76 m up to but not including 90 m	8 m

<sup>156</sup> To categorise the aeroplanes using the aerodrome, first evaluate their overall length and second, their fuselage width.

<sup>157</sup> See guidance in the ICAO Airport Services Manual (Doc 9137), Part 1 for categorising aerodromes, including those for all-cargo aircraft operations, for rescue and fire fighting purposes. Principles and procedures on training, including training programmes and competence checks, are specified in the ICAO PANS-Aerodromes (Doc 9981). Further guidance on the training of personnel, rescue equipment for difficult environment and other facilities and services for rescue and fire fighting is given in ICAO Annex 14, Vol.I, Attachment A, Section 17 and in the Airport Services Manual (Doc 9137), Part 1.

- 12.1.4 During anticipated periods of reduced activity, the level of protection available must be no less than that needed for the highest category of aeroplane planned to use the aerodrome during that time irrespective of the number of movements.

*Extinguishing agents*

- 12.1.5 Both principal and complementary agents<sup>158</sup> must be provided at an aerodrome.

- 12.1.6 The principal extinguishing agent must be:

- (a) a foam meeting the minimum performance level A; or
- (b) a foam meeting the minimum performance level B; or
- (c) a foam meeting the minimum performance level C; or
- (d) a combination of these agents;

except that the principal extinguishing agent for aerodromes in categories 1 to 3 must meet the minimum performance<sup>159</sup> level B or C foam.

- 12.1.7 The amounts of water for foam production and the complementary agents to be provided on the rescue and fire fighting vehicles must be in accordance with the aerodrome category determined under paragraphs 12.1.1, 12.1.2, 12.1.3, and Table 12-2, except that for aerodrome categories 1 and 2 up to 100 per cent of the water may be substituted with complementary agent.

For the purpose of agent substitution, 1 kg of complementary agent must be taken as equivalent to 1.0L of water for production of a foam meeting performance level A<sup>160</sup>.

- 12.1.8 At aerodromes where operations by aeroplanes larger than the average size in a given category are planned, the quantities of water must be recalculated and the amount of water for foam production and the discharge rates for foam solution must be increased accordingly<sup>161</sup>.

- 12.1.9 The quantity of foam concentrates separately provided on vehicles for foam production must be in proportion to the quantity of water provided and the foam concentrate selected.

- 12.1.10 The amount of foam concentrate provided on a vehicle must be sufficient to produce at least two loads of foam solution.

- 12.1.11 Supplementary water supplies, for the expeditious replenishment of rescue and fire fighting vehicles at the scene of an aircraft accident, must be provided.

---

<sup>158</sup> Descriptions of the agents may be found in the ICAO Airport Services Manual (Doc 9137), Part 1.

<sup>159</sup> Information on the required physical properties and fire extinguishing performance criteria needed for a foam to achieve an acceptable performance level A, B or C rating is given in the ICAO Airport Services Manual (Doc 9137), Part 1.

<sup>160</sup> The amounts of water specified for foam production are predicated on an application rate of 8.2 L/min/m<sup>2</sup> for a foam meeting performance level A, 5.5 L/min/m<sup>2</sup> for a foam meeting performance level B and 3.75L/min/m<sup>2</sup> for a foam meeting performance level C. When any other complementary agent is used, the substitution ratios need to be checked.

<sup>161</sup> Guidance on the determination of quantities of water and discharge rates based on the largest overall length of aeroplane in a given category is available in Chapter 2 of the ICAO Airport Services Manual (Doc 9137), Part 1.

- 12.1.12 When a combination of different performance level foams are provided at an aerodrome, the total amount of water to be provided for foam production must be calculated for each foam type and the distribution of these quantities must be documented for each vehicle and applied to the overall rescue and firefighting requirement.
- 12.1.13 The discharge rate of the foam solution must not be less than the rates shown in Table 12-2.

Table 12-2 - Minimum usable amounts of extinguishing agents

Aerodrome category	Foam meeting performance level A		Foam meeting performance level B		Foam meeting performance level C		Complementary agents	
	Water (L)	Discharge rate foam solution/minute (L)	Water (L)	Discharge rate foam solution/minute (L)	Water (L)	Discharge rate foam solution/minute (L)	Dry chemical powders (kg)	Discharge Rate kg/sec
(1)	(2)	(3)	(4)	(5)	(6)	(7)	(8)	(9)
1	350	350	230	230	160	160	45	2.25
2	1 000	800	670	550	460	360	90	2.25
3	1 800	1 300	1 200	900	820	630	135	2.25
4	3 600	2 600	2 400	1 800	1 700	1 100	135	2.25
5	8 100	4 500	5 400	3 000	3 900	2 200	180	2.25
6	11 800	6 000	7 900	4 000	5 800	2 900	225	2.25
7	18 200	7 900	12 100	5 300	8 800	3 800	225	2.25
8	27 300	10 800	18 200	7 200	12 800	5 100	450	4.5
9	36 400	13 500	24 300	9 000	17 100	6 300	450	4.5
10	48 200	16 600	32 300	11 200	22 800	7 900	450	4.5

*Note — The quantities of water shown in columns 2, 4 and 6 are based on the average overall length of aeroplanes in a given category.*

- 12.1.14 The complementary agents must comply with the appropriate specifications of the International Organization for Standardization (ISO) <sup>162</sup> or equivalent<sup>163</sup>.
- 12.1.15 The discharge rate of complementary agents must be no less than the rates shown in Table 12-2.
- 12.1.16 A reserve supply of foam concentrate, equivalent to 200 per cent of the quantities identified in Table 12-2, must be maintained on the aerodrome for vehicle replenishment purposes<sup>164</sup>.

<sup>162</sup> See ISO Publication 7202(Powder).

<sup>163</sup> Compliance to the Singapore Standard for fire extinguishers (SS 232) can also be considered

<sup>164</sup> Foam concentrate carried on fire vehicles in excess of the quantity identified in Table 12-2 can contribute to the reserve.



- 12.1.17 A reserve supply of complementary agent, equivalent to 100 per cent of the quantity identified in Table 12-2, must be maintained on the aerodrome for vehicle replenishment purposes. Sufficient propellant gas must be included to utilize this reserve complementary agent.
- 12.1.18 Category 1 and 2 aerodromes that have replaced up to 100 per cent of the water with complementary agent must hold a reserve supply of complementary agent of 200 per cent.

*Rescue equipment*

- 12.1.19 Rescue equipment<sup>165</sup> commensurate with the level of aircraft operations must be provided on the rescue and fire fighting vehicle(s).

*Response time*

- 12.1.20 The operational objective of the rescue and firefighting service must be to achieve a response time not exceeding two minutes to any point of each operational runway, in optimum visibility and surface conditions.
- 12.1.21 The operational objective of the rescue and firefighting service must be to achieve a response time not exceeding three minutes to any other part of the movement area in optimum visibility and surface conditions<sup>166</sup>.
- 12.1.22 Any vehicles, other than the first responding vehicles(s), required to deliver the amounts of extinguishing agents specified in Table 12-2 must ensure continuous agent application and must arrive no more than three minutes from the initial call.
- 12.1.23 A system of preventive maintenance of rescue and fire fighting vehicles must be employed to ensure effectiveness of the equipment and compliance with the specified response time throughout the life of the vehicle.

*Emergency access roads*

- 12.1.24 Emergency access roads<sup>167</sup> must be provided on an aerodrome where terrain conditions permit their construction, so as to facilitate achieving minimum response times. Particular attention must be given to the provision of ready access to approach areas up to 1,000m from the threshold, or at least within the aerodrome boundary. Where a fence is provided, the need for convenient access to outside areas must be taken into account.
- 12.1.25 Emergency access roads must be capable of supporting the heaviest vehicles which will use them, and be usable in all weather conditions. Roads within 90 m of a runway must be surfaced to prevent surface erosion and the transfer of debris to the runway. Sufficient vertical clearance must be provided from overhead obstructions for the largest vehicles.

---

<sup>165</sup> Guidance on the rescue equipment to be provided at an aerodrome is given in the ICAO Airport Services Manual (Doc 9137), Part 1.

<sup>166</sup> Optimum visibility and surface conditions are defined as daytime, good visibility, no precipitation with normal response route free of surface contamination e.g. water.

<sup>167</sup> Aerodrome service roads may serve as emergency access roads when they are suitably located and constructed.

*Fire stations*

- 12.1.26 All rescue and fire fighting vehicles must normally be housed in a fire station. Satellite fire stations must be provided whenever the response time cannot be achieved from a single fire station.
- 12.1.27 The fire station must be located so that the access for rescue and fire fighting vehicles into the runway area is direct and clear, requiring a minimum number of turns.

*Communication and alerting systems*

- 12.1.28 A discrete communication system must be provided linking a fire station with the control tower, any other fire station on the aerodrome and the rescue and fire fighting vehicles.
- 12.1.29 An alerting system for rescue and firefighting personnel, capable of being operated from that station, must be provided at a fire station, any other fire station on the aerodrome and the aerodrome control tower.

*Number of rescue and fire fighting vehicles*

- 12.1.30 The minimum number of rescue and fire fighting vehicles<sup>168</sup> provided at an aerodrome must be in accordance with the following tabulation:

<u>Aerodrome category</u>	<u>Rescue and fire fighting vehicles</u>
1	1
2	1
3	1
4	1
5	1
6	2
7	2
8	3
9	3
10	3

---

<sup>168</sup> Guidance on minimum characteristics of rescue and fire fighting vehicles is given in the ICAO Airport Services Manual (Doc 9137), Part 1.

*Personnel*

12.1.31 An aerodrome operator must ensure that training in the following areas for all aerodrome rescue and firefighting (ARFF) personnel is conducted by a training organisation that is approved (“approved ARFF training organisation”) or provided by the DGCA.

- (a) basic firemanship<sup>169</sup>;
- (b) recurrent training; and
- (c) leadership training, appropriate to their areas of responsibilities, for personnel performing supervisory roles.

12.1.32 In determining the minimum number of rescue and firefighting personnel required, a task resource analysis<sup>170</sup> must be completed.

**12.2 Other special services**

*Emergency hand signals*

12.2.1 The signals shown in ICAO Annex 2, Appendix 1, Section 6 must, when used, have the meaning indicated therein. They must be used only for the purpose indicated and no other signals likely to be confused with them must be used.

**12.3 Apron management service**

12.3.1 An emergency vehicle responding to an emergency must be given priority over all other surface movement traffic.

12.3.2 A vehicle operating on an apron must:

- (a) give way to an emergency vehicle; an aircraft taxiing, about to taxi, or being pushed or towed; and
- (b) give way to other vehicles.

12.3.3 An aircraft stand must be visually monitored to ensure that the recommended clearance distances are provided to an aircraft using the stand<sup>171</sup>.

---

<sup>169</sup> Guidance on areas of training which constitutes basic firemanship is given in ICAO Annex 14 Vol. I, Attachment A, Section 17 and ICAO Airport Services Manual (Doc 9137), Part 1. Airport and aircraft familiarisation will, however, be covered under on-the-job training in the station the ARFF is posted to, and not during their basic firemanship training at the training organisation.

<sup>170</sup> Guidance on the use of a task resource analysis can be found in the ICAO Airport Services Manual (Doc 9137), Part 1.

<sup>171</sup> Procedures on the training of operational personnel and on apron safety and operations, are specified in the ICAO PANS-Aerodromes (Doc 9981), Part II, Chapters 1 and 7.

## **12.4 Surface movement guidance and control systems**

### *Characteristics*

- 12.4.1 The visual aid components of a surface movement guidance and control system, i.e. markings, lights and signs must be designed to conform with the relevant specifications in paragraphs 8.2, 8.3 and 8.4, respectively.
- 12.4.2 Where a surface movement guidance and control system is provided by selective switching of stop bars and taxiway centre line lights<sup>172</sup>, the following requirements must be met:
- (a) taxiway routes which are indicated by illuminated taxiway centre line lights must be capable of being terminated by an illuminated stop bar;
  - (b) the control circuits must be so arranged that when a stop bar located ahead of an aircraft is illuminated the appropriate section of taxiway centre line lights beyond it is suppressed; and
  - (c) the taxiway centre line lights are activated ahead of an aircraft when the stop bar is suppressed.

## **12.5 Siting of equipment and installations on operational areas**

- 12.5.1 Unless its function requires it to be there for air navigation or for aircraft safety purposes, no equipment or installation must be:
- (a) on a runway strip, a runway end safety area, a taxiway strip or within the distances specified in Table 6-1, column 11, if it would endanger an aircraft; or
  - (b) on a clearway if it would endanger an aircraft in the air.
- 12.5.2 Any equipment or installation required for air navigation or for aircraft safety purposes which must be located:
- (a) on that portion of a runway strip within:
    - (1) 75 m of the runway centre line where the code number is 3 or 4; or
    - (2) 45 m of the runway centre line where the code number is 1 or 2; or
  - (b) on a runway end safety area, a taxiway strip or within the distances specified in Table 6-1; or
  - (c) on a clearway and which would endanger an aircraft in the air;
- must be frangible and mounted as low as possible.

---

<sup>172</sup> Guidance on installation of stop bars and taxiway centre line lights in surface movement guidance and control systems is given in the ICAO Aerodrome Design Manual, (Doc 9157), Part 4 and the Advanced Surface Movement Guidance and Control Systems (A-SMGCS) Manual (Doc 9830).

- 12.5.3 Any equipment or installation required for air navigation or for aircraft safety purposes which must be located on the non-graded portion of a runway strip must be regarded as an obstacle and must be frangible and mounted as low as possible<sup>173</sup>.
- 12.5.4 Unless its function requires it to be there for air navigation or for aircraft safety purposes, no equipment or installation must be located within 240 m from the end of the strip and within:
- (a) 60 m of the extended centre line where the code number is 3 or 4; or
  - (b) 45 m of the extended centre line where the code number is 1 or 2;
- of a precision approach runway category I, II or III.
- 12.5.5 Any equipment or installation required for air navigation or for aircraft safety purposes which must be located on or near a strip of a precision approach runway category I, II or III and which:
- (a) is situated within 240 m from the end of the strip and within:
    - (1) 60 m of the extended runway centre line where the code number is 3 or 4; or
    - (2) 45 m of the extended runway centre line where the code number is 1 or 2; or
  - (b) penetrates the inner approach surface, the inner transitional surface or the balked landing surface;
- must be frangible and mounted as low as possible.

## **12.6 Fencing**

### *Application*

- 12.6.1 A fence or other suitable barrier must be provided on an aerodrome to prevent the entrance to the movement area of animals large enough to be a hazard to aircraft.
- 12.6.2 A fence or other suitable barrier must be provided on an aerodrome to deter the inadvertent or premeditated access of an unauthorized person onto a non-public area of the aerodrome<sup>174</sup>.
- 12.6.3 Suitable means of protection must be provided to deter the inadvertent or premeditated access of unauthorized persons into ground installations and facilities essential for the safety of civil aviation located off the aerodrome.

---

<sup>173</sup> Guidance on the siting of navigation aids is contained in the ICAO Aerodrome Design Manual (Doc 9157), Part 6.

<sup>174</sup> This is intended to include the barring of sewers, ducts tunnels etc., where necessary to prevent access. Special measures may be required to prevent the access of an unauthorised person to runways or taxiways which overpass public roads.

*Location*

- 12.6.4 The fence or barrier must be located so as to separate the movement area and other facilities or zones on the aerodrome vital to the safe operation of aircraft from areas open to public access.

**12.7 Security lighting**

- 12.7.1 At an aerodrome where it is necessary for security reasons, a fence or other barrier provided for the protection of international civil aviation and its facilities must be illuminated at a minimum essential level. Consideration must be given to locating lights so that the ground area on both sides of the fence or barrier, particularly at access points, is illuminated.

**12.8 Autonomous runway incursion warning system**

- 12.8.1 The inclusion of detailed specification for an autonomous runway incursion warning system (ARIWS) in this section is not intended to imply that an ARIWS has to be provided at an aerodrome. The implementation of an ARIWS is a complex issue deserving careful consideration by aerodrome operators, ATS provider, DGCA and in coordination with the aircraft operators. Attachment A, Section 20 of ICAO Annex 14 Vol. I, provides a description of an ARIWS and information on its use.

*Characteristics*

- 12.8.2 For any failure of part or all of it where an autonomous runway incursion warning system<sup>175</sup> is installed at an aerodrome, the aerodrome operator must have provision to allow the ATC unit to partially or entirely shut down the system.
- 12.8.3 Where an ARIWS is installed at an aerodrome, information on its characteristics and status must be provided to the Aeronautical Information Service (AIS) for promulgation in the AIP<sup>176</sup> with the description of the aerodrome surface movement guidance and control system and markings as specified in ICAO Annex 15.

---

<sup>175</sup> An ARIWS may be installed in conjunction with enhanced taxiway centre line markings, stop bars or runway guard lights. It is intended that the system(s) be operational under all weather conditions, including low visibility. An ARIWS may share common sensory components of an SMGCS or A-SMGCS, however, it operates independently of either system.

<sup>176</sup> Detailed specifications concerning the AIP are contained in ICAO PANS-AIM (Doc 10066).

## 13 Aerodrome Maintenance

### 13.1 Pavements

- 13.1.1 The surfaces of all movement areas including pavements (runways, taxiways, and aprons) and adjacent areas must be inspected and their conditions monitored regularly as part of an aerodrome preventive and corrective maintenance programme with the objective of avoiding and eliminating any foreign object debris (FOD) that might cause damage to aircraft or impair the operation of aircraft systems<sup>177</sup>.
- 13.1.2 The surface of a runway must be maintained in a condition such as to prevent formation of harmful irregularities<sup>178</sup>.
- 13.1.3 A paved runway must be maintained in a condition so as to provide surface friction characteristics at or above the minimum friction level specified in Table 13-1<sup>179</sup>.

#### *Runway friction measurement*

- 13.1.4 Runway surface friction characteristics for maintenance purposes must be periodically measured with a continuous friction measuring device using self-wetting features and documented. The frequency of these measurements must be sufficient to determine the trend of the surface friction characteristics<sup>179</sup> of the runway.
- 13.1.5 When runway surface friction measurements are made for maintenance purposes using a self-wetting continuous friction measuring device, the performance of the device must meet the criteria stated in ICAO Airport Service manual (Doc 9137), Part 2.
- 13.1.6 Personnel measuring runway surface friction required in paragraph 13.1.5 must be trained to fulfil their duties.
- 13.1.7 Corrective maintenance action must be taken to prevent the runway surface friction characteristics for either the entire runway or a portion thereof from falling below a minimum friction level<sup>180</sup> specified in Table 13-1.

---

<sup>177</sup> See paragraph 5.9.3 for inspections of movement areas. Procedures on carrying out daily inspections of the movement area and control of FOD are given in the ICAO PANS-Aerodromes (Doc 9981), the Manual of Surface Movement Guidance and Control Systems (SMGCS) (Doc 9476) and the Advanced Surface Movement Guidance and Control Systems (A-SMGCS) Manual (Doc 9830). Additional guidance on sweeping/cleaning of surfaces is contained in the ICAO Airport Services Manual (Doc 9137), Part 9. Guidance on precautions to be taken in regard to the surface of shoulders is given in ICAO Annex 14 Vol. I, Attachment A, Section 8, and the ICAO Aerodrome Design Manual (Doc 9157), Part 2. Where the pavement is used by large aircraft or aircraft with tire pressures in the upper categories referred to in paragraph 5.6.6(c), particular attention should be given to the integrity of light fittings in the pavement and pavement joints.

<sup>178</sup> See ICAO Annex 14 Vol. I, Attachment A, Section 5.

<sup>179</sup> Guidance on evaluating the runway surface friction characteristics is provided in the ICAO Assessment, Measurement and Reporting of Runway Surface Conditions (Cir 355).

<sup>180</sup> A portion of runway in the order of 100m long may be considered significant for maintenance or reporting action.

Table 13-1 – Guidelines for establishing the design objective, maintenance planning level and minimum friction levels of runways in use

Test equipment	Test tire		Test speed (km/h)	Test water depth (mm)	Design objective for new surface	Maintenance planning level	Minimum friction level
	Type	Pressure (kPa)					
(1)	(2)		(3)	(4)	(5)	(6)	(7)
Mu-meter Trailer	A	70	65	1.0	0.72	0.52	0.42
	A	70	95	1.0	0.66	0.38	0.26
Skiddometer Trailer	B	210	65	1.0	0.82	0.60	0.50
	B	210	95	1.0	0.74	0.47	0.34
Surface Friction Tester Vehicle	B	210	65	1.0	0.82	0.60	0.50
	B	210	95	1.0	0.74	0.47	0.34
Runway Friction Tester Vehicle	B	210	65	1.0	0.82	0.60	0.50
	B	210	95	1.0	0.74	0.54	0.41
TATRA Friction Tester Vehicle	B	210	65	1.0	0.76	0.57	0.48
	B	210	95	1.0	0.67	0.52	0.42
GRIPTESTER Trailer	C	140	65	1.0	0.74	0.53	0.43
	C	140	95	1.0	0.64	0.36	0.24

### 13.2 Removal of contaminants

13.2.1 Standing water, mud, dust, sand, oil, rubber deposits and other contaminants must be removed from the surface of runways in use as rapidly and completely as possible to minimize accumulation<sup>181</sup>.

13.2.2 Chemicals which may have harmful effects on aircraft or pavements, or chemicals which may have toxic effects on the aerodrome environment, must not be used.

### 13.3 Runway pavement overlays

13.3.1 The following specifications are intended for runway pavement overlay projects when the runway is to be returned temporarily to an operational status before resurfacing<sup>182</sup> is complete. This may necessitate a temporary ramp between the new and old runway surfaces.

<sup>181</sup> Guidance on removal of other contaminants is given in the ICAO PANS-Aerodromes (Doc 9981).

<sup>182</sup> Guidance on overlaying pavements and assessing their operational status is given in the ICAO Aerodrome Design Manual (Doc 9157), Part 3.



13.3.2 The longitudinal slope of the temporary ramp, measured with reference to the existing runway surface or previous overlay course, must be:

- (a) 0.5 to 1.0 per cent for overlays up to and including 5cm in thickness; and
- (b) not more than 0.5 per cent for overlays more than 5cm in thickness.

13.3.3 Before a runway being overlaid is returned to a temporary operational status, a runway centre line marking conforming to the specifications in paragraph 8.2.3 must be provided. Additionally, the location of any temporary threshold must be identified by a 3.6m wide transverse stripe.

#### **13.4 Visual aids**

13.4.1 The following specifications are intended to define the maintenance performance level objectives. They are not intended to define whether the lighting system is operationally out of service.

13.4.2 A light must be deemed to be unserviceable when the main beam average intensity is less than 50 per cent of the value specified in the appropriate figure in Appendix 3. For light units where the designed main beam average intensity is above the value shown in Appendix 3, the 50 per cent value must be related to that design value.

13.4.3 A system of preventive maintenance of visual aids<sup>183</sup> must be employed to ensure lighting and marking system reliability.

---

<sup>183</sup> Guidance on preventive maintenance of visual aids is given in the ICAO Airport Services Manual (Doc 9137), Part 9.

13.4.4 The system of preventive maintenance employed for a precision approach runway category II or III must have as its objective that, during any period of category II or III operations, all approach and runway lights are serviceable, and that in any event at least:

- (a) 95 per cent of the lights are serviceable in each of the following particular significant elements:
  - (1) precision approach category II and III lighting system, the inner 450m;
  - (2) runway centre line lights;
  - (3) runway threshold lights; and
  - (4) runway edge lights;
- (b) 90 per cent of the lights are serviceable in the touchdown zone lights;
- (c) 85 per cent of the lights are serviceable in the approach lighting system beyond 450m; and
- (d) 75 per cent of the lights are serviceable in the runway end lights.

In order to provide continuity of guidance, the allowable percentage of unserviceable lights must not be permitted in such a way as to alter the basic pattern of the lighting system. Additionally, an unserviceable light must not be permitted adjacent to another unserviceable light, except in a barrette<sup>184</sup> or a crossbar where two adjacent unserviceable lights may be permitted.

13.4.5 The system of preventive maintenance employed for a stop bar provided at a runway-holding position used in conjunction with a runway intended for operations in runway visual range conditions less than a value of 350m must have the following objectives:

- (a) no more than two lights will remain unserviceable; and
- (b) two adjacent lights will not remain unserviceable unless the light spacing is significantly less than that specified.

13.4.6 The system of preventive maintenance employed for a taxiway intended for use in runway visual range conditions less than a value of 350m must have as its objective that no two adjacent taxiway centre line lights be unserviceable.

---

<sup>184</sup> With respect to barrettes, crossbars and runway edge lights, lights are considered to be adjacent if located consecutively and:

- laterally: in the same barrette or crossbar; or
- longitudinally: in the same row of edge lights or barrettes.

- 13.4.7 The system of preventive maintenance employed for a precision approach runway category I must have as its objective that, during any period of category I operations, all approach and runway lights are serviceable, and that in any event at least 85 per cent of the lights are serviceable in each of the following:
- (a) precision approach category I lighting system;
  - (b) runway threshold lights;
  - (c) runway edge lights; and
  - (d) runway end lights.

In order to provide continuity of guidance<sup>185</sup> an unserviceable light must not be permitted adjacent to another unserviceable light unless the light spacing is significantly less than that specified.

- 13.4.8 The system of preventive maintenance employed for a runway meant for take-off in runway visual range conditions less than a value of 550m must have as its objective that, during any period of operations, all runway lights are serviceable and that in any event:
- (a) at least 95 per cent of the lights are serviceable in the runway centre line lights (where provided) and in the runway edge lights; and
  - (b) at least 75 per cent of the lights are serviceable in the runway end lights.

In order to provide continuity of guidance, an unserviceable light must not be permitted adjacent to another unserviceable light.

- 13.4.9 The system of preventive maintenance employed for a runway meant for take-off in runway visual range conditions of a value of 550m or greater must have as its objective that, during any period of operations, all runway lights are serviceable and that, in any event, at least 85 per cent of the lights are serviceable in the runway edge lights and runway end lights. In order to provide continuity of guidance, an unserviceable light must not be permitted adjacent to another unserviceable light.

---

<sup>185</sup> In barrettes and crossbars, guidance is not lost by having two adjacent unserviceable lights.

## Appendix 1 Definitions

<u>Definition</u>	<u>Meaning</u>
Aerodrome beacon	Aeronautical beacon used to indicate the location of an aerodrome from the air.
Aerodrome elevation	The elevation of the highest point of the landing area.
Aerodrome identification sign	A sign placed on an aerodrome to aid in identifying the aerodrome from the air.
Aerodrome mapping data (AMD)	Data collected for the purpose of compiling aerodrome mapping information for aeronautical uses.  <i>Note.— Aerodrome mapping data are collected for purposes that include the improvement of the user's situational awareness, surface navigation operations, training, charting and planning.</i>
Aerodrome mapping database (AMDB)	A collection of aerodrome mapping data organized and arranged as a structured data set.
Aerodrome operator	In relation to a certified aerodrome, means the holder of an Aerodrome Certificate.
Aerodrome reference point	The designated geographical location of an aerodrome.
Aerodrome traffic density	a) <i>Light</i> . Where the number of movements in the mean busy hour is not greater than 15 per runway or typically less than 20 total aerodrome movements.  b) <i>Medium</i> . Where the number of movements in the mean busy hour is of the order of 16 to 25 per runway or typically between 20 to 35 total aerodrome movements.  c) <i>Heavy</i> . Where the number of movements in the mean busy hour is of the order of 26 or more per runway or typically more than 35 total aerodrome movements.  <i>Note 1.— The number of movements in the mean busy hour is the arithmetic mean over the year of the number of movements in the daily busiest hour.</i> <i>Note 2.— Either a take-off or a landing constitutes a movement.</i>
Aeronautical beacon	An aeronautical ground light visible at all azimuths, either continuously or intermittently, to designate a particular point on the surface of the earth.
Aeronautical ground light	Any light specially provided as an aid to air navigation, other than a light displayed on an aircraft.

Aeroplane reference field length	<p>The minimum field length required for take-off at maximum certificated take-off mass, sea-level, standard atmospheric conditions, still air and zero runway slope, as shown in the appropriate aeroplane flight manual prescribed by the certificating authority or equivalent data from the aeroplane manufacturer. Field length means balanced field length for aeroplanes, if applicable, or take-off distance in other cases.</p> <p><i>Note – Attachment A, Section 2 of the ICAO Annex 14 provides information on the concept of balanced field length and the ICAO Airworthiness Manual (Doc 9760) contains detailed guidance on matters related to take-off distance.</i></p>
Agencies	<p>Examples of agencies are:</p> <ul style="list-style-type: none"> <li>- on the aerodrome: air traffic control units, rescue and firefighting services, aerodrome administration, medical and ambulance services, aircraft operators, security services, and police;</li> <li>- off the aerodrome: fire departments, police, health authorities (including medical, ambulance, hospital and public health services), military, and harbour patrol or coast guard.</li> </ul>
Aircraft Classification Number	<p>A number expressing the relative effect of an aircraft on a pavement for a specified standard subgrade category.</p> <p><i>Note – The aircraft classification number is calculated with respect to the centre of gravity (CG) position which yields the critical loading on the critical gear. Normally the aftmost CG position appropriate to the maximum gross apron (ramp) mass is used to calculate the ACN. In exceptional cases the forwardmost CG position may result in the nose gear loading being more critical.</i></p>
Air traffic control unit	<p>Includes area control centre, approach control unit and aerodrome control tower.</p>
Air traffic services unit	<p>Includes air traffic control unit, flight information centre or air traffic services reporting office.</p>
Arresting System	<p>A system designed to decelerate an aeroplane overrunning the runway.</p>
Balked Landing	<p>A landing manoeuvre that is unexpectedly discontinued at any point below the obstacle clearance altitude/height (OCA/H).</p>
Barrette	<p>Three or more aeronautical ground lights closely spaced in a transverse line so that from a distance they appear as a short bar of light.</p>
Calendar	<p>Discrete temporal reference system that provides the basis for defining temporal position to a resolution of one day (ISO 19108*).</p>

Certified aerodrome	Means an aerodrome whose operator has been granted an Aerodrome Certificate.
Clearway	A defined rectangular area on the ground or water under the control of the aerodrome operator, selected or prepared as a suitable area over which an aeroplane may make a portion of its initial climb to a specified height.
Cyclic redundancy check (CRC)	A mathematical algorithm applied to the digital expression of data that provides a level of assurance against loss or alteration of data.
Data accuracy	A degree of conformance between the estimated or measured value and the true value.
Data integrity (assurance level).	A degree of assurance that an aeronautical data and its value has not been lost or altered since the origination or authorised amendment.
Data quality	A degree or level of confidence that the data provided meet the requirements of the data user in terms of accuracy, resolution and integrity (or equivalent assurance level), traceability, timeliness, completeness and format
Controlled aerodrome	An aerodrome provided with air traffic control services
Datum	Any quantity or set of quantities that may serve as a reference or basis for the calculation of other quantities (ISO 19104*).
Declared distances	<p>a) <i>Take-off run available (TORA)</i>. The length of runway declared available and suitable for the ground run of an aeroplane taking off.</p> <p>b) <i>Take-off distance (TODA)</i>. The length of the take-off run available plus the length of the clearway, if provided.</p> <p>c) <i>Accelerate-stop distance available (ASDA)</i>. The length of the take-off run available plus the length of the stopway, if provided.</p> <p>d) <i>Landing distance available (LDA)</i>. The length of runway which is declared available and suitable for the ground run of an aeroplane landing.</p>
Dependent parallel approaches	Simultaneous approaches to parallel or near-parallel instrument runways where radar separation minima between aircraft on adjacent extended runway centre lines are prescribed.
Displaced threshold	A threshold not located at the extremity of a runway.

Effective intensity	The effective intensity of a flashing light is equal to the intensity of a fixed light of the same colour which will produce the same visual range under identical conditions of observation.
Ellipsoid height (Geodetic height)	The height related to the reference ellipsoid, measured along the ellipsoidal outer normal through the point in question.
Emergencies	Examples of emergencies are: aircraft emergencies, sabotage including bomb threats, unlawfully seized aircraft, dangerous goods occurrences, building fires, and natural disaster and public health emergencies.
Fixed light	A light having constant luminous intensity when observed from a fixed point.
Foreign Object Debris (FOD)	An inanimate object within the movement area which has no operational or aeronautical function and which has the potential to be a hazard to aircraft operations.
Frangible object	An object of low mass designed to break, distort or yield on impact so as to present the minimum hazard to aircraft.  <i>Note - Guidance on design for frangibility is contained in the Aerodrome Design Manual (Doc 9157), Part 6.</i>
Geodetic datum.	A minimum set of parameters required to define location and orientation of the local reference system with respect to the global reference system/frame.
Geoid	The equipotential surface in the gravity field of the Earth which coincides with the undisturbed mean sea level (MSL) extended continuously through the continents.  <i>Note - The geoid is irregular in shape because of local gravitational disturbances (wind tides, salinity, current, etc.) and the direction of gravity is perpendicular to the geoid at every point.</i>
Geoid undulation	The distance of the geoid above (positive) or below (negative) the mathematical reference ellipsoid.  <i>Note - In respect to the World Geodetic System – 1984 (WGS-84) defined ellipsoid, the difference between the WGS-84 ellipsoidal height and orthometric height represents WGS-84 geoid undulation.</i>
Gregorian calendar	Calendar in general use; first introduced in 1582 to define a year that more closely approximates the tropical year than the Julian calendar (ISO 19108*).  <i>Note – In the Gregorian calendar, common years have 365 days and leap years 366 days divided into 12 sequential months.</i>

Hazard beacon	An aeronautical beacon used to designate a danger to air navigation.
Holding bay	A defined area where aircraft can be held, or bypassed, to facilitate efficient surface movement of aircraft.
Hot spot	A location on an aerodrome movement area with a history or potential risk of collision or runway incursion, and where heightened attention by pilots/drivers is necessary
Identification beacon	An aeronautical beacon emitting a coded signal by means of which a particular point of reference can be identified.
Independent parallel approaches	Simultaneous approaches to parallel or near-parallel instrument runways where radar separation minima between aircraft on adjacent extended runway centre lines are not prescribed.
Independent parallel departures	Simultaneous departures from parallel or near-parallel instrument runways.
Instrument runway	<p>One of the following types of runways intended for the operation of aircraft using instrument approach procedures:</p> <p>a) <i>Non-precision approach runway.</i> A runway served by visual aids and non-visual aid(s) intended for landing operations following an instrument approach operation type A and a visibility not less than 1000m.</p> <p>b) <i>Precision approach runway, category I.</i> A runway served by visual aids and non-visual aid(s) intended for landing operations following an instrument approach operation type B with a decision height(DH) not lower than 60m (200 ft) and either a visibility not less than 800m or a runway visual range not less than 550m.</p> <p>c) <i>Precision approach runway, category II.</i> A runway served by visual aids and non-visual aid(s) intended for landing operations following an instrument approach operation type B with a decision height (DH) lower than 60m (200 ft) but not lower than 30m (100 ft) and a runway visual range not less than 300m.</p> <p>d) <i>Precision approach runway, category III.</i> A runway served by visual aids and non-visual aid(s) intended for landing operations following an instrument approach operation type B with a decision height (DH) lower than 30m (100ft), or no decision height and a runway visual range less than 300m or no runway visual range limitations.</p> <p><i>Note 1.— Visual aids need not necessarily be matched to the scale of non-visual aids provided. The criterion</i></p>



	<i>for the selection of visual aids is the conditions in which operations are intended to be conducted. Note 2.— Refer to ICAO Annex 6 — Operation of Aircraft for instrument approach operation types.</i>
Integrity classification (aeronautical data)	Classification based upon the potential risk resulting from the use of corrupted data. Aeronautical data is classified as: <ul style="list-style-type: none"> <li>a) Routine data: there is a very low probability when using corrupted routine data that the continued safe flight and landing of an aircraft would be severely at risk with the potential for catastrophe;</li> <li>b) Essential data: there is a low probability when using corrupted essential data that the continued safe flight and landing of an aircraft would be severely at risk with the potential for catastrophe; and</li> <li>c) Critical data: there is a high probability when using corrupted critical data that the continued safe flight and landing of an aircraft would be severely at risk with the potential for catastrophe.</li> </ul>
Intermediate holding position	A designated position intended for traffic control at which taxiing aircraft and vehicles must stop and hold until further cleared to proceed, when so instructed by the aerodrome control tower.
Landing area	That part of a movement area intended for the landing or take-off of aircraft.
Landing direction indicator	A device to indicate visually the direction currently designated for landing and take-off.
Laser-beam critical flight zone (LCFZ)	Airspace in the proximity of an aerodrome but beyond the LFFZ where the irradiance is restricted to a level unlikely to cause glare effects.
Laser-beam free flight zone (LFFZ)	Airspace in the immediate proximity of the aerodrome where the irradiance is restricted to a level unlikely to cause any visual disruption.
Laser-beam sensitive flight zone (LSFZ)	Airspace outside, and not necessarily contiguous with, the LFFZ and LCFZ where the irradiance is restricted to a level unlikely to cause flash-blindness or after-image effects.
Lighting system reliability	The probability that the complete installation operates within the specified tolerances and that the system is operationally usable.
Marker	An object displayed above ground level in order to indicate an obstacle or delineate a boundary.
Marking	A symbol or group of symbols displayed on the surface of the movement area in order to convey aeronautical information.

Near-parallel runways	Non-intersecting runways whose extended centre lines have an angle of convergence/divergence of 15 degrees or less
Non-instrument runway	A runway intended for the operation of aircraft using visual approach procedures or an instrument approach procedure to a point beyond which the approach may continue in visual meteorological conditions.  <i>Note – Visual meteorological conditions (VMC) are described in Chapter 3 of ICAO Annex 2.</i>
Obstacle free zone (OFZ)	The airspace above the inner approach surface, inner transitional surfaces, and balked landing surface and that portion of the strip bounded by these surfaces, which is not penetrated by any fixed obstacle other than a low-mass and frangibly mounted one required for air navigation purposes.
Optimum visibility and surface conditions	Means daytime, good visibility, no precipitation with normal response route free of surface contamination e.g. water.
Orthometric height	Height of a point related to the geoid, generally presented as an MSL elevation.
Outer main gear wheel span (OMGWS)	The distance between the outside edges of the main gear wheels.
Pavement classification number (PCN)	A number expressing the bearing strength of a pavement.
Precision approach runway	See ‘Instrument runway’.
Pre-flight information bulletin	Means a presentation of current NOTAM information of operational significance, prepared prior to flight.
Primary runway(s)	Runway(s) used in preference to others whenever conditions permit.
Public health emergencies	Examples of public health emergencies are increased risk of travellers or cargo spreading a serious communicable disease internationally through air transport and severe outbreak of a communicable disease potentially affecting a large proportion of aerodrome staff.
Public health services	Include planning to minimise adverse effects to the community from health related events and deal with population health issues rather than provision of health services to individuals.
Road	An established surface route on the movement area meant for the exclusive use of vehicles.
Road-holding position	A designated position at which vehicles may be required to hold.

Runway condition assessment matrix (RCAM)	A matrix allowing the assessment of the runway condition code, using associated procedures, from a set of observed runway surface condition(s) and pilot report of braking action.
Runway condition code (RWYCC)	A number describing the runway surface condition to be used in the runway condition report. <i>Note.— The purpose of the runway condition code is to permit an operational aeroplane performance calculation by the flight crew. Procedures for the determination of the runway condition code are described in the ICAO PANS-Aerodromes (Doc 9981).</i>
Runway condition report (RCR)	A comprehensive standardised report relating to runway surface conditions and its effect on the aeroplane landing and take-off performance
Runway end safety area (RESA)	An area symmetrical about the extended runway centre line and adjacent to the end of the strip primarily intended to reduce the risk of damage to an aeroplane undershooting or overrunning the runway.
Runway guard lights	A light system intended to caution pilots or vehicle drivers that they are about to enter an active runway.
Runway-holding position	A designated position intended to protect a runway, an obstacle limitation surface, or an ILS/MLS critical/sensitive area at which taxiing aircraft and vehicles must stop and hold, unless otherwise authorized by the aerodrome control tower. <i>Note – In radiotelephony phraseologies, the expression “holding point” is used to designate the runway-holding position.</i>
Runway surface condition(s)	A description of the condition of the runway surface used in the runway condition report, which establishes the basis for the determination of the runway condition code for aeroplane performance purposes, as follows: <ul style="list-style-type: none"> <li>(a) Dry runway. A runway whose surface is free of visible moisture and not contaminated within the intended area of use.</li> <li>(b) Wet runway. A runway whose surface is covered by any visible dampness or water up to and including 3 mm deep within the intended area of use.</li> <li>(c) Slippery wet runway. A runway which has a significant portion of its surface determined to have degraded surface friction characteristics.</li> <li>(d) Contaminated runway. A runway which has a significant portion of its surface covered by standing water (whether in isolated areas or not) within the length and width of the intended area of use.</li> </ul>

	<p><i>Note 1. — The runway surface conditions used in the runway condition report establish the performance requirements between the aerodrome operator, aeroplane manufacturer and aeroplane operator.</i></p> <p><i>Note 2. — Procedures on determining runway surface conditions and contaminant coverage on runway are available in the ICAO PANS-Aerodromes (Doc 9981).</i></p>
Runway turn pad	A defined area on a land aerodrome adjacent to a runway for the purpose of completing a 180-degree turn on a runway.
Runway visual range (RVR)	The range over which the pilot of an aircraft on the centreline of a runway can see the runway surface markings or the lights delineating the runway or identifying its centreline.
Segregated parallel operations	Simultaneous operations on parallel or near-parallel instrument runways in which one runway is used exclusively for approaches and the other runway is used exclusively for departures.
Shoulder	An area adjacent to the edge of a pavement so prepared as to provide a transition between the pavement and the adjacent surface.
Sign	<p>a) <i>Fixed message sign.</i> A sign presenting only one message.</p> <p>b) <i>Variable message sign.</i> A sign capable of presenting several pre-determined messages or no message, as applicable.</p>
Signal area	An area on an aerodrome used for the display of ground signals.
Standing water	Water (including running water) of depth greater than 3mm
Stopway	A defined rectangular area on the ground at the end of take-off run available prepared as a suitable area in which an aircraft can be stopped in the case of an abandoned take-off.
Switch-over time (light)	The time required for the actual intensity of a light measured in a given direction to fall from 50 per cent and recover to 50 per cent during a power supply change-over, when the light is being operated at intensities of 25 per cent or above.
Take-off runway	A runway intended for take-off only.
Taxiway intersection	A junction of two or more taxiways.
Taxiway strip	An area including a taxiway intended to protect an aircraft operating on the taxiway and to reduce the risk of damage to an aircraft accidentally running off the taxiway.

Threshold	The beginning of that portion of the runway usable for landing.
Touchdown zone	The portion of a runway, beyond the threshold, where it is intended landing aeroplanes first contact the runway.
Usability factor	The percentage of time during which the use of a runway or system of runways is not restricted because of the cross-wind component.  <i>Note - Cross wind component means the surface wind component at right angles to the runway centre line.</i>
Unserviceable area	A part of the movement area that is unfit and unavailable for use by aircraft.
<b>Note:</b>	
Terms and definitions that are shown in singular above must also take on the same meaning when they are expressed in plural form in this Manual and vice versa.	
* ISO Standard 19104, <i>Geographic Information – Terminology</i>	
* ISO Standard 19108, <i>Geographic Information – Temporal schema</i>	

## Appendix 2 Colours for aeronautical ground lights, markings, signs and panels

### 1. General

- 1.1 The following specifications define the chromaticity limits of colours to be used for aeronautical ground lights, markings, signs and panels. The specifications are in accord with the 1983 specifications of the International Commission on Illumination (CIE), except for the colour orange in Figure A2-2.
- 1.2 It is not possible to establish specifications for colours such that there is no possibility of confusion. For reasonably certain recognition, it is important that the eye illumination be well above the threshold of perception, that the colour not be greatly modified by selective atmospheric attenuations and that the observer's colour vision be adequate. There is also a risk of confusion of colour at an extremely high level of eye illumination such as may be obtained from a high-intensity source at very close range. Experience indicates that satisfactory recognition can be achieved if due attention is given to these factors.
- 1.3 The chromaticities are expressed in terms of the standard observer and coordinate system adopted by the International Commission on Illumination (CIE) at its Eighth Session at Cambridge, England, in 1931.
- 1.4 The chromaticities for solid state lighting (e.g. LED) are based upon the boundaries given in the standard S 004/E-2001 of the International Commission on Illumination (CIE), except for the blue boundary of white.

### 2. Colours for aeronautical ground lights

#### 2.1 Chromaticities for lights having filament-type light sources

- 2.1.1 The chromaticities<sup>186</sup> of aeronautical ground lights with filament-type light sources must be within the following boundaries:

CIE Equations (see Figure A2-1a):

- (a) Red  
 Purple boundary  $y = 0.980 - x$   
 Yellow boundary  $y = 0.335$ , except for visual approach slope indicator systems  
 Yellow boundary  $y = 0.320$ , for visual approach slope indicator systems
- (b) Yellow  
 Red boundary  $y = 0.382$   
 White boundary  $y = 0.790 - 0.667x$   
 Green boundary  $y = x - 0.120$
- (c) Green  
 Yellow boundary  $x = 0.360 - 0.080y$   
 White boundary  $x = 0.650y$   
 Blue boundary  $y = 0.390 - 0.171x$

<sup>186</sup> Guidance on chromaticity changes resulting from the effect of temperature on filtering elements is given in the ICAO Aerodrome Design Manual (Doc 9157), Part 4.

- (d) Blue  
Green boundary  $y = 0.805x + 0.065$   
White boundary  $y = 0.400 - x$   
Purple boundary  $x = 0.600y + 0.133$
- (e) White  
Yellow boundary  $x = 0.500$   
Blue boundary  $x = 0.285$   
Green boundary  $y = 0.440$  and  $y = 0.150 + 0.640x$   
Purple boundary  $y = 0.050 + 0.750x$  and  $y = 0.382$
- (f) Variable white  
Yellow boundary  $x = 0.255 + 0.750y$  and  $y = 0.790 - 0.667x$   
Blue boundary  $x = 0.285$   
Green boundary  $y = 0.440$  and  $y = 0.150 + 0.640x$   
Purple boundary  $y = 0.050 + 0.750x$  and  $y = 0.382$

## 2.2 Chromaticities for lights having a solid state light source

### 2.2.1 The chromaticities of aeronautical ground lights with solid state light sources, e.g. LEDs, must be within the following boundaries:

CIE Equations (see Figure A2-1b):

- (a) Red  
Purple boundary  $y = 0.980 - x$   
Yellow boundary  $y = 0.335$ , except for visual approach slope indicator systems  
Yellow boundary  $y = 0.320$ , for visual approach slope indicator systems
- (b) Yellow  
Red boundary  $y = 0.387$   
White boundary  $y = 0.980 - x$   
Green boundary  $y = 0.727x + 0.054$
- (c) Green  
Yellow boundary  $x = 0.310$   
White boundary  $x = 0.625y - 0.041$   
Blue boundary  $y = 0.400$
- (d) Blue  
Green boundary  $y = 1.141x - 0.037$   
White boundary  $y = 0.400 - y$   
Purple boundary  $x = 0.134 + 0.590y$
- (e) White  
Yellow boundary  $x = 0.440$   
Blue boundary  $x = 0.320$   
Green boundary  $y = 0.150 + 0.643x$   
Purple boundary  $y = 0.050 + 0.757x$
- (f) Variable white  
The boundaries of variable white for solid state light sources are those of e) White above.

2.3 Colour measurement for filament-type and solid state-type light sources

2.3.1 The colour of aeronautical ground lights must be verified as being within the boundaries specified in Figure A2-1a or A2-1b, as appropriate, by measurement at five points within the area limited by the innermost isocandela curve<sup>187</sup> (isocandela diagrams in Appendix 3 refer), with operation at rated current or voltage. In the case of elliptical or circular isocandela curves, the colour measurements must be taken at the centre and at the horizontal and vertical limits. In the case of rectangular isocandela curves, the colour measurements must be taken at the centre and the limits of the diagonals (corners). In addition, the colour of the light must be checked at the outermost isocandela curve to ensure that there is no colour shift that might cause signal confusion to the pilot.

2.3.2 In the case of visual approach slope indicator systems and other light units having a colour transition sector, the colour must be measured at points in accordance with 2.3.1, except that the colour areas must be treated separately and no point must be within 0.5 degrees of the transition sector.

**3. Colours<sup>188</sup> for markings, signs and panels**

3.1 The chromaticities and luminance factors of ordinary colours, colours of retroreflective materials and colours of transilluminated (internally illuminated) signs and panels must be determined under the following standard conditions:

- (a) angle of illumination: 45°;
- (b) direction of view: perpendicular to surface; and
- (c) illuminant: CIE standard illuminant D<sub>65</sub>.

---

<sup>187</sup> For the outermost isocandela curve, a measurement of colour coordinates should be made and recorded for review. Certain light units may have application so that they may be viewed and used by pilots from directions beyond that of the outermost isocandela curve (e.g. stop bar lights at significantly wide runway-holding positions). In such instances, the State should assess the actual application and if necessary require a check of colour shift at angular ranges beyond the outermost curve.

<sup>188</sup> The specifications of surface colours given below apply only to freshly coloured surfaces. Colours used for markings, signs and panels usually change with time and therefore require renewal. Guidance on surface colours is contained in the CIE document entitled Recommendations for Surface Colours for Visual Signalling — Publication No. 39-2 (TC 106) 1983.



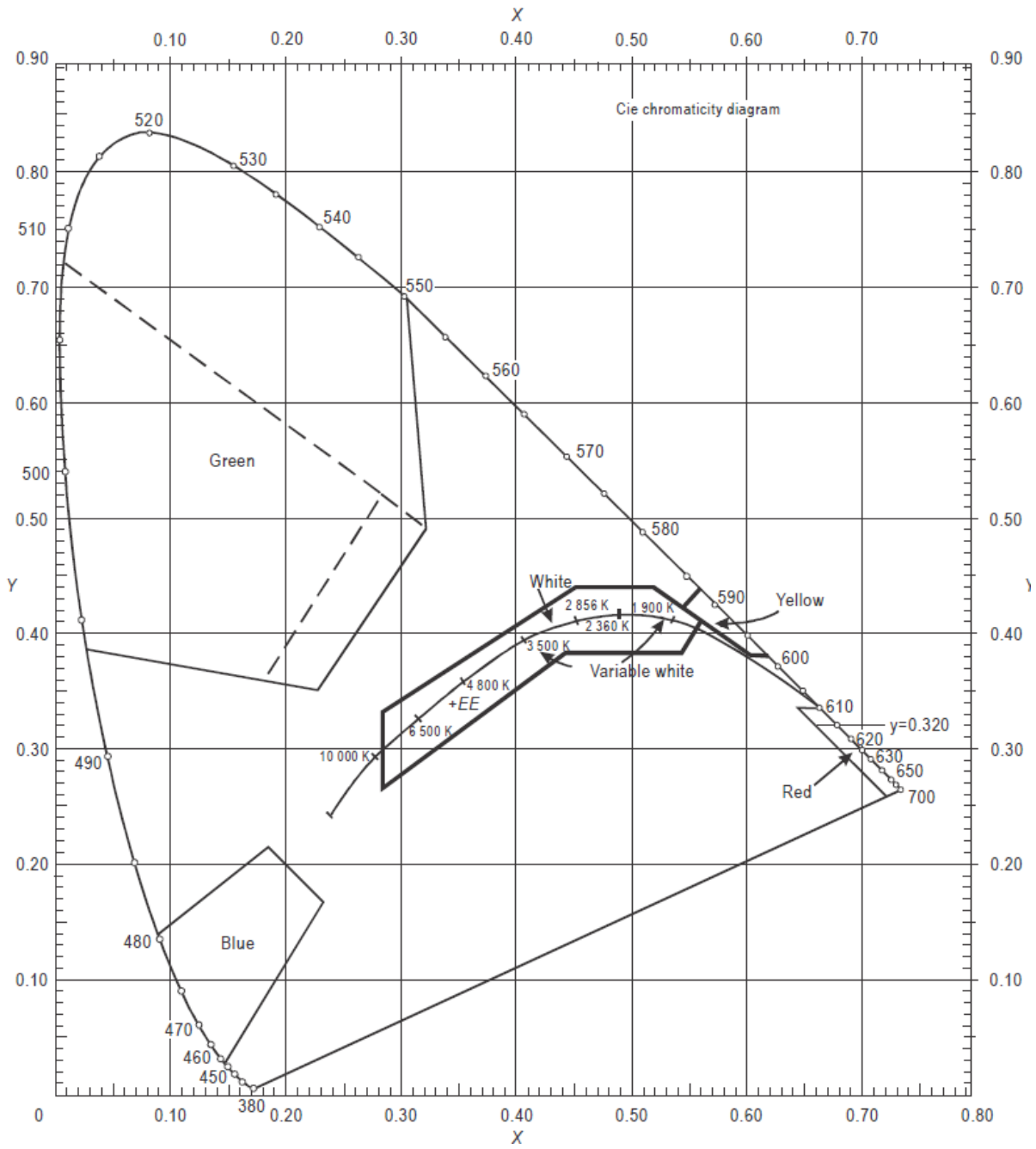

Figure A2-1a. Colours for aeronautical ground lights (filament-type lamps)

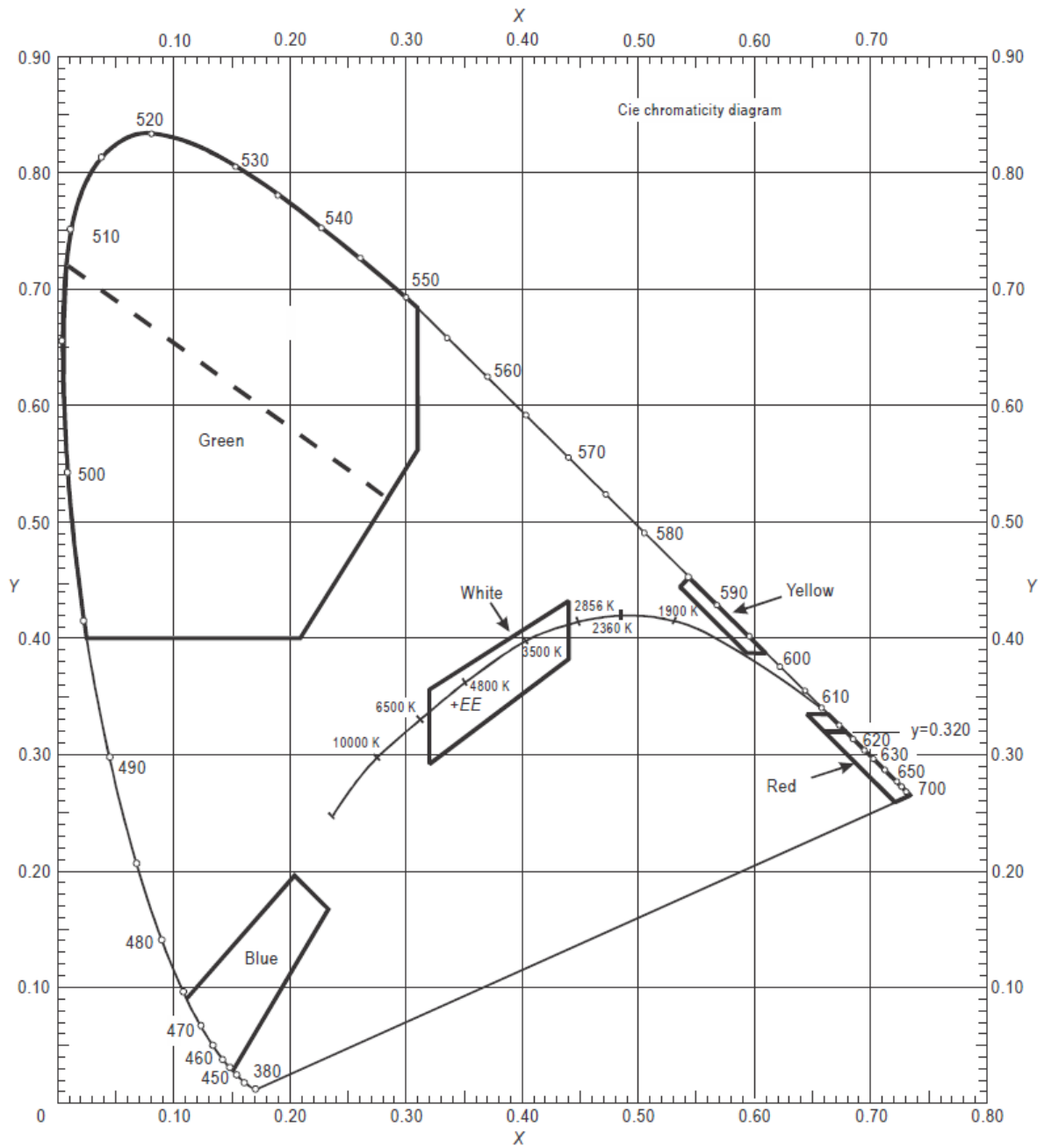

Figure A2-1b. Colours for aeronautical ground lights (solid state lighting)

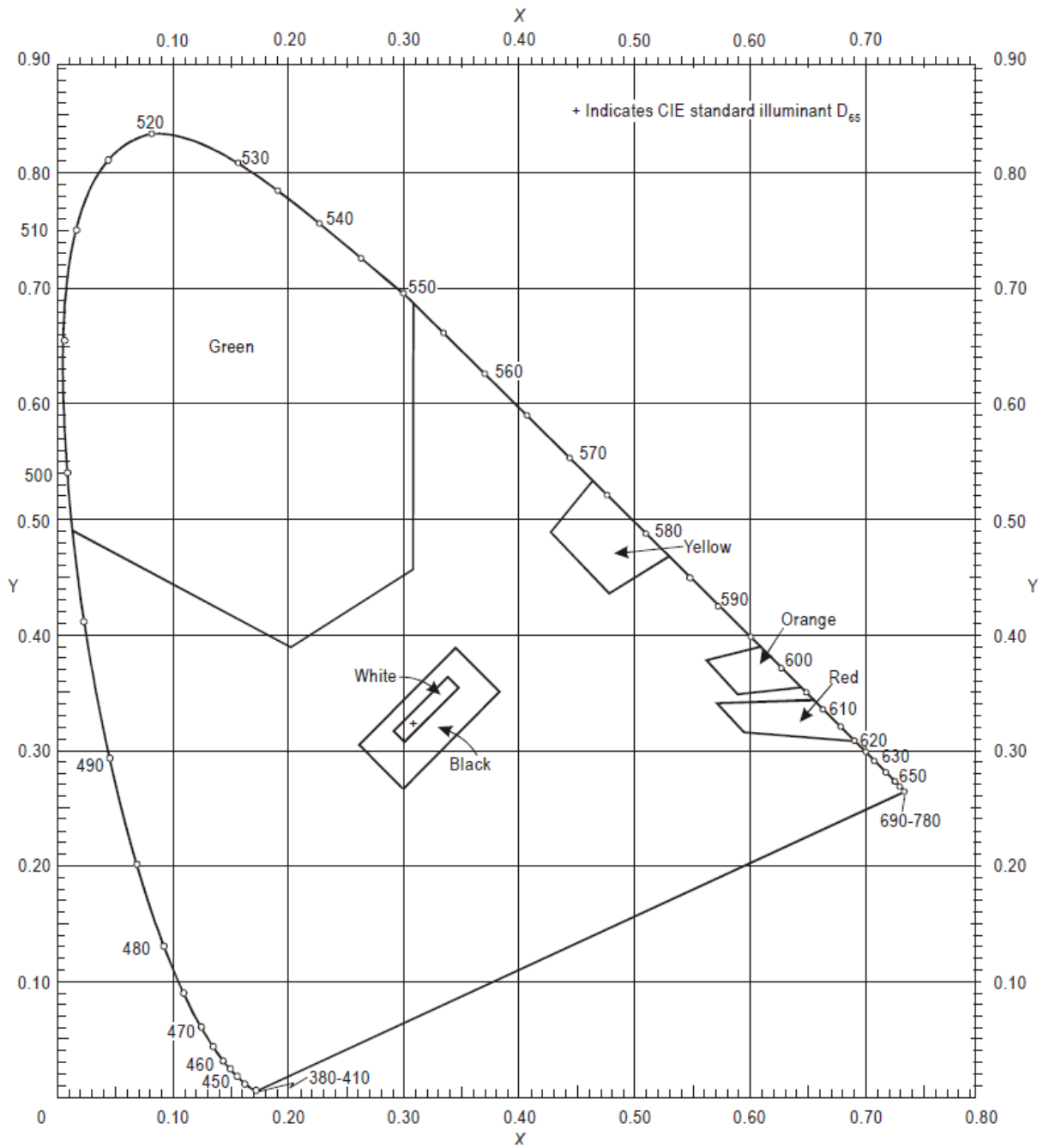
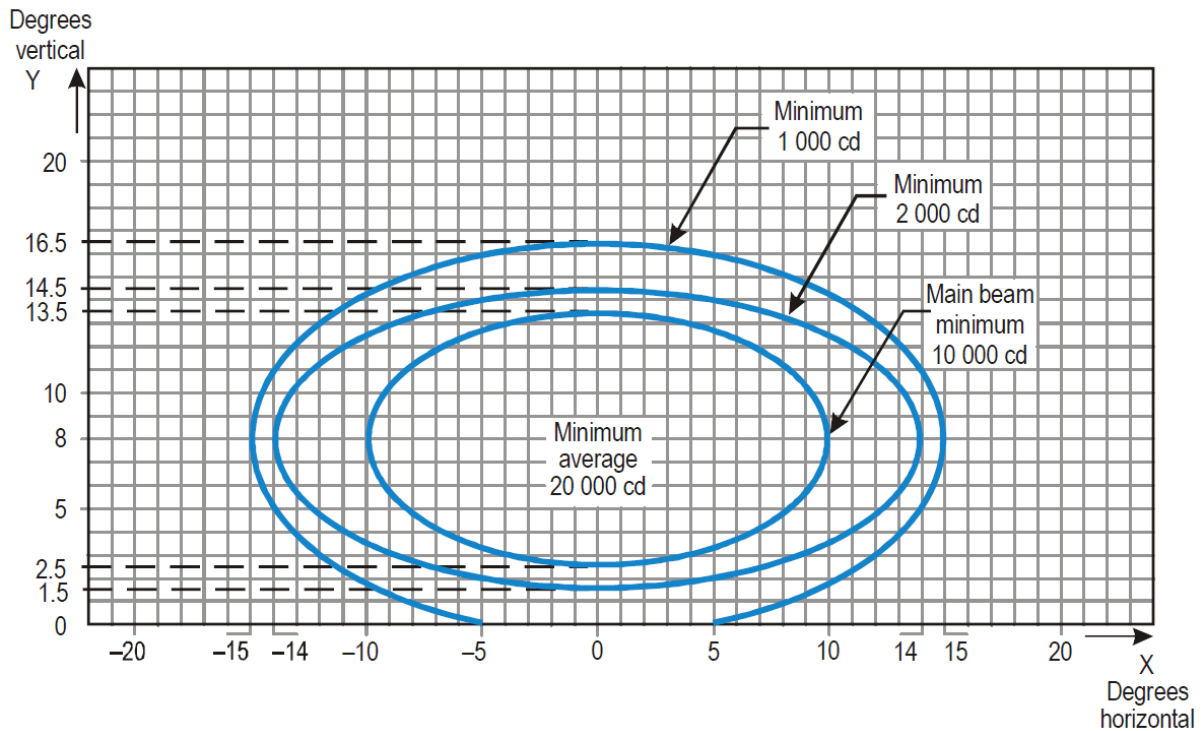

Figure A2-2. Ordinary colours for markings and externally illuminated signs and panels

## Appendix 3 Aeronautical ground light characteristics



**Notes:**

1. Curves calculated on formula x

$$\frac{x^2}{a^2} + \frac{y^2}{b^2} = 1$$

a	10	14	15
b	5.5	6.5	8.5

2. Vertical setting angles of the lights must be such that the following vertical coverage of the main beam will be met:

<i>distance from threshold</i>	<i>vertical main beam coverage</i>
<i>threshold to 315 m</i>	<i>0° — 11°</i>
<i>316 m to 475 m</i>	<i>0.5° — 11.5°</i>
<i>476 m to 640 m</i>	<i>1.5° — 12.5°</i>
<i>641 m and beyond</i>	<i>2.5° — 13.5° (as illustrated above)</i>

3. Lights in crossbars beyond 22.5 m from the centre line must be toed-in 2 degrees. All other lights must be aligned parallel to the centre line of the runway.

4. See collective notes for Figures A3-1 to A3-11 and A3-26.

**Figure A3-1. Isocandela diagram for approach centre line light and crossbars (white light)**

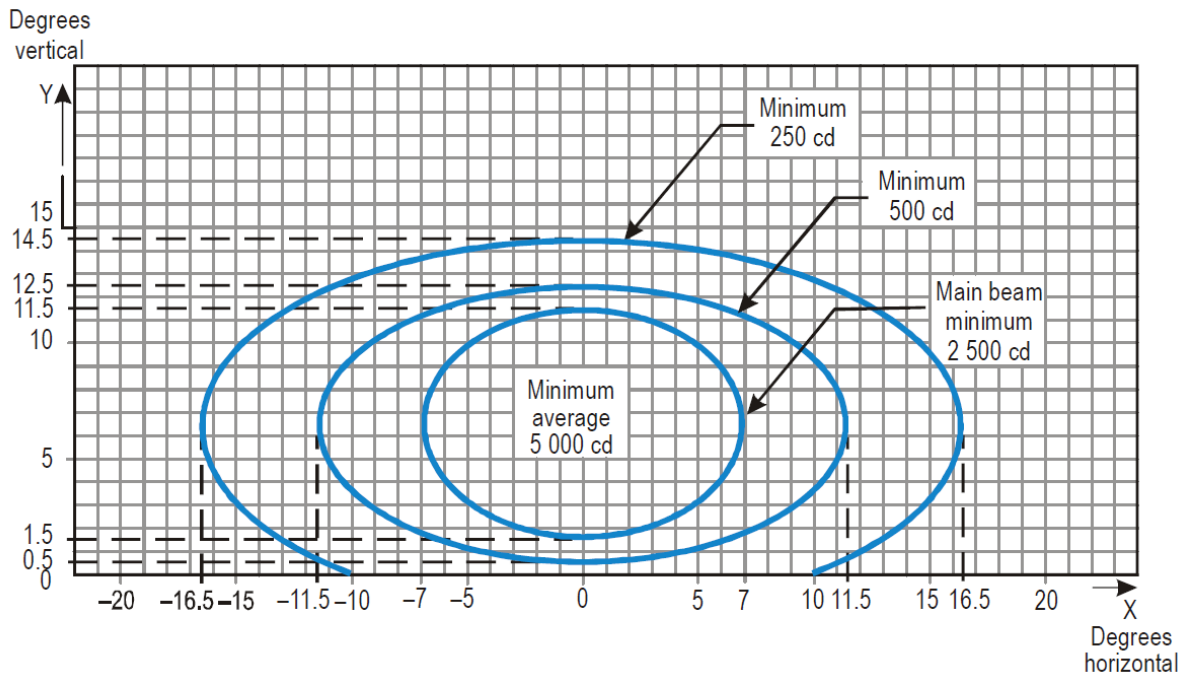

**Notes:**

1. Curves calculated on formula  $x$

$$\frac{x^2}{a^2} + \frac{y^2}{b^2} = 1$$

a	7.0	11.5	16.5
b	5.0	6.0	8.0

2. Toe-in 2 degrees

3. Vertical setting angles of the lights must be such that the following vertical coverage of the main beam will be met:

distance from threshold

vertical main beam coverage

threshold to 115 m

0.5° — 10.5°

116 m to 215 m

1° — 11°

216 m and beyond

1.5° — 11.5° (as illustrated above)

4. See collective notes for Figures A3-1 to A3-11 and A3-26.

**Figure A3-2. Isocandela diagram for approach side row light (red light)**

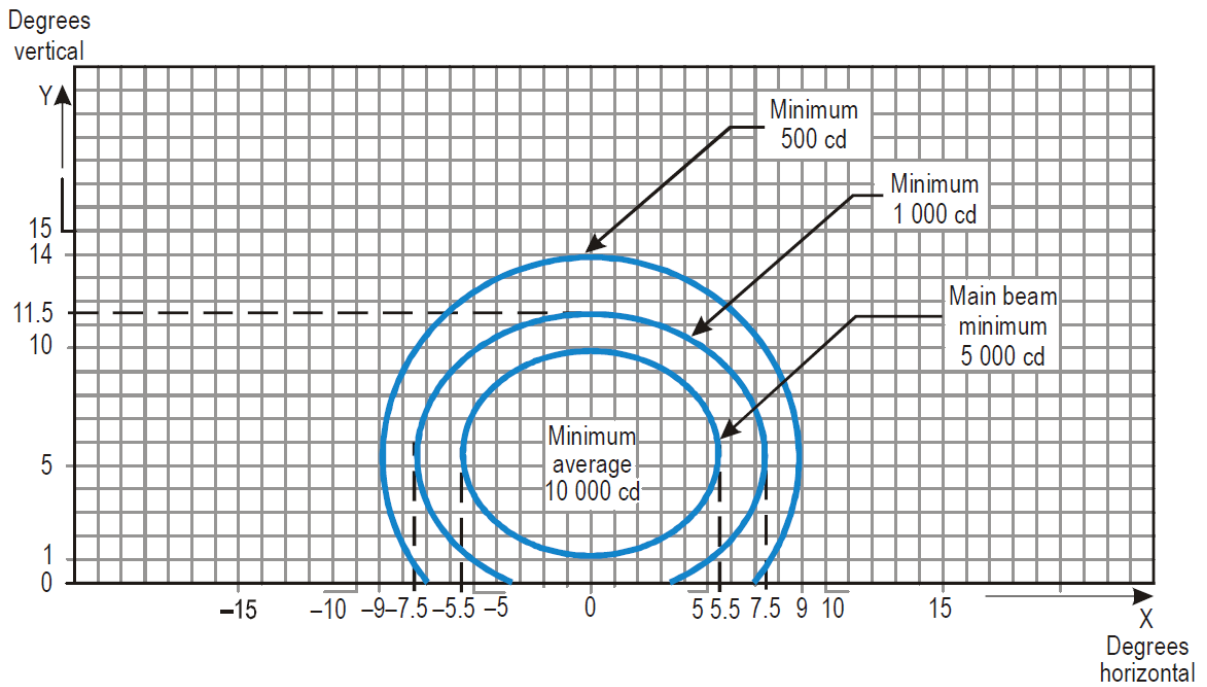

**Notes:**

1. Curves calculated on formula  $x$

$$\frac{x^2}{a^2} + \frac{y^2}{b^2} = 1$$

a	5.5	7.5	9.0
b	4.5	6.0	8.5

2. Toe-in 3.5 degrees

3. See collective notes for Figures A3-1 to A3-11 and A3-26.

**Figure A3-3. Isocandela diagram for threshold light (green light)**

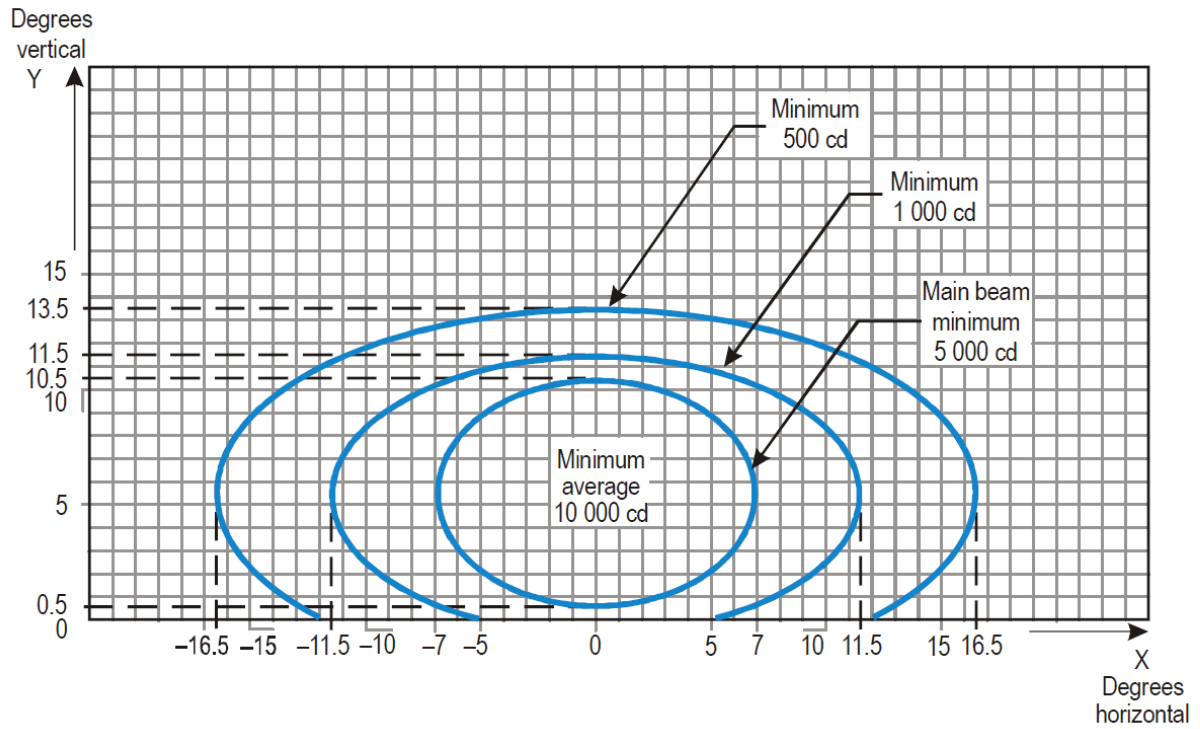

Notes:

1. Curves calculated on formula x

$\frac{x^2}{a^2} + \frac{y^2}{b^2} = 1$	a	7.0	11.5	16.5
	b	5.0	6.0	8.0

2. Toe-in 2 degrees

3. See collective notes for Figures A3-1 to A3-11 and A3-26.

**Figure A3-4. Isocandela diagram for threshold wing bar light (green light)**

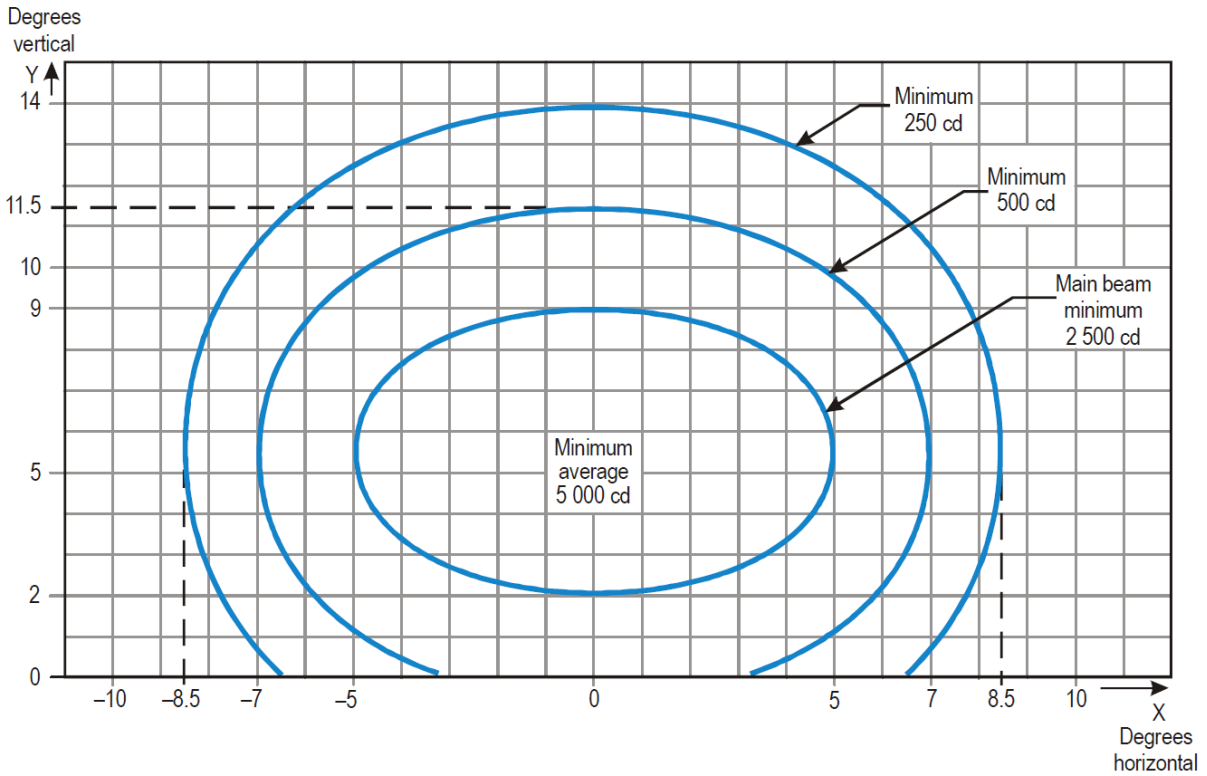

**Notes:**

1. Curves calculated on formula  $x$

$$\frac{x^2}{a^2} + \frac{y^2}{b^2} = 1$$

a	5.0	7.0	8.5
b	3.5	6.0	8.5

2. Toe-in 4 degrees

3. See collective notes for Figures A3-1 to A3-11 and A3-26.

**Figure A3-5. Isocandela diagram for touchdown zone light (white light)**



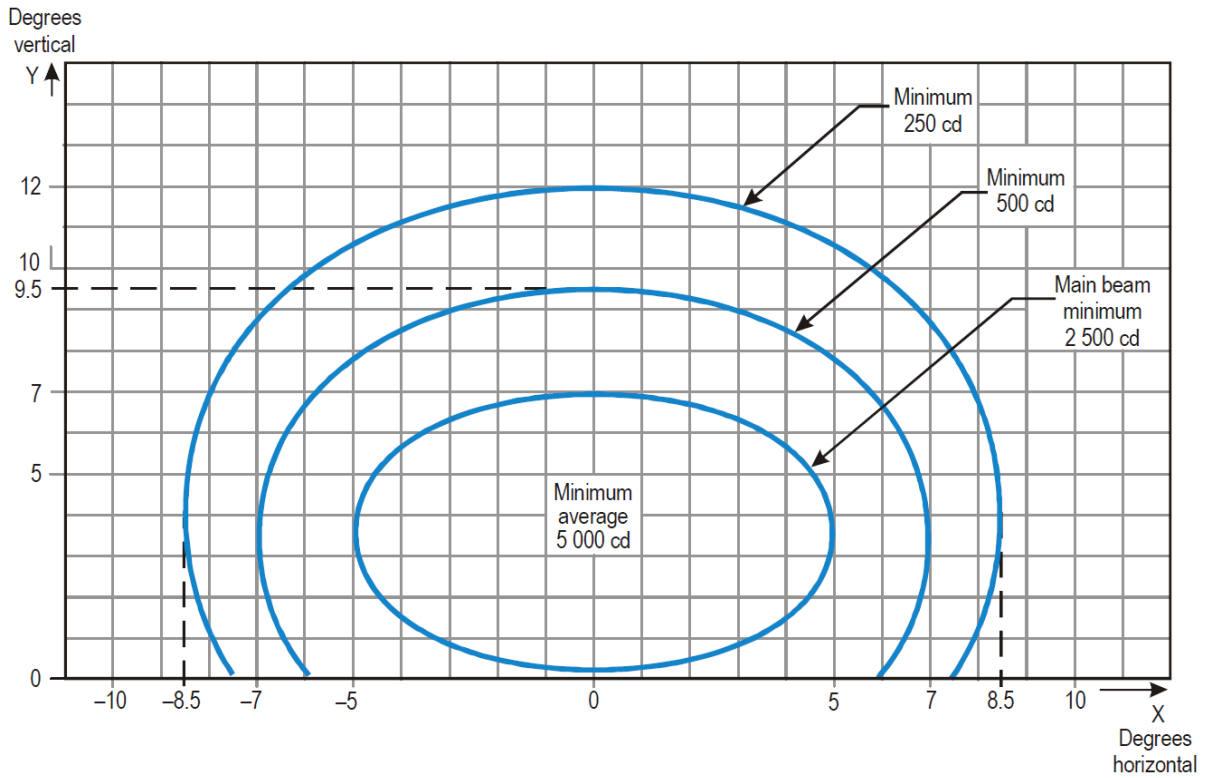

**Notes:**

1. Curves calculated on formula x

$\frac{x^2}{a^2} + \frac{y^2}{b^2} = 1$	a	5.0	7.0	8.5
	b	3.5	6.0	8.5

2. For red light, multiply values by 0.15.

3. For yellow light, multiply values by 0.40.

4. See collective notes for Figures A3-1 to A3-11 and A3-26.

**Figure A3-6. Isocandela diagram for runway centre line light with 30 m longitudinal spacing (white light) and rapid exit taxiway indicator light (yellow light)**

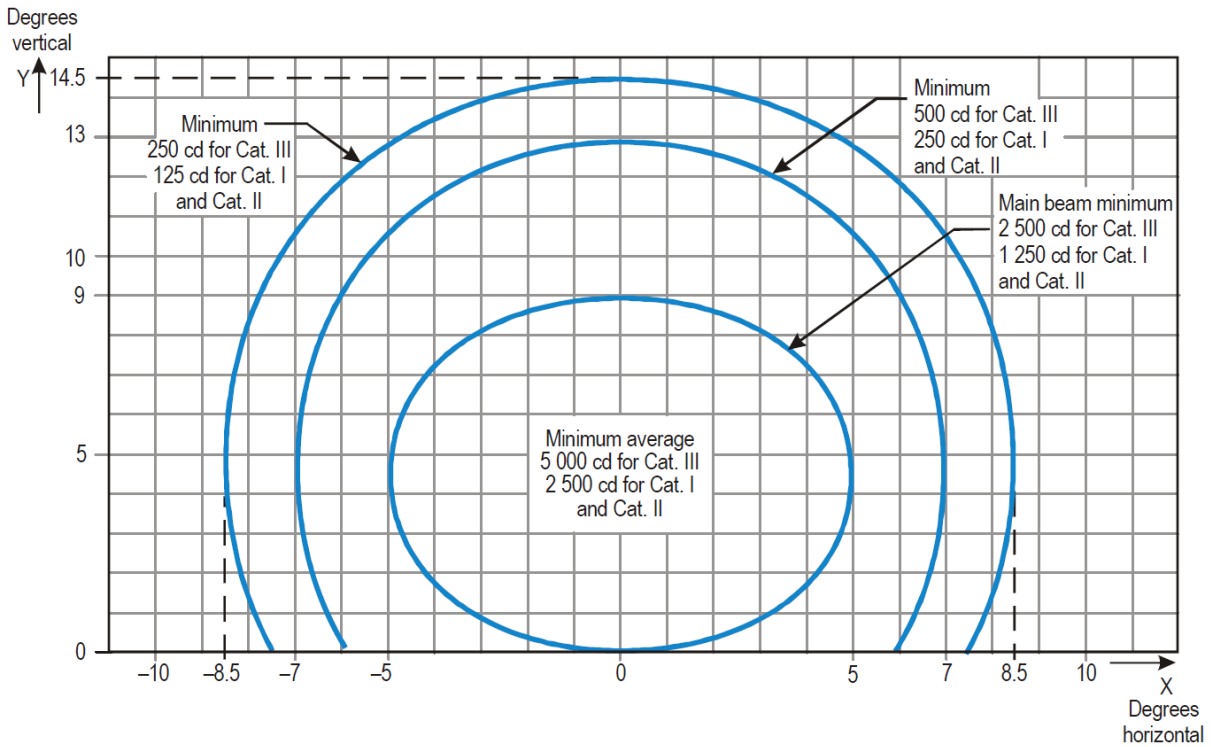

**Notes:**

1. Curves calculated on formula  $x$

$\frac{x^2}{a^2} + \frac{y^2}{b^2} = 1$	a	5.0	7.0	8.5
	b	4.5	8.5	10

2. For red light, multiply values by 0.15.

3. For yellow light, multiply values by 0.40.

4. See collective notes for Figures A3-1 to A3-11 and A3-26.

**Figure A3-7. Isocandela diagram for runway centre line light with 15 m longitudinal spacing (white light) and rapid exit taxiway indicator light (yellow light)**

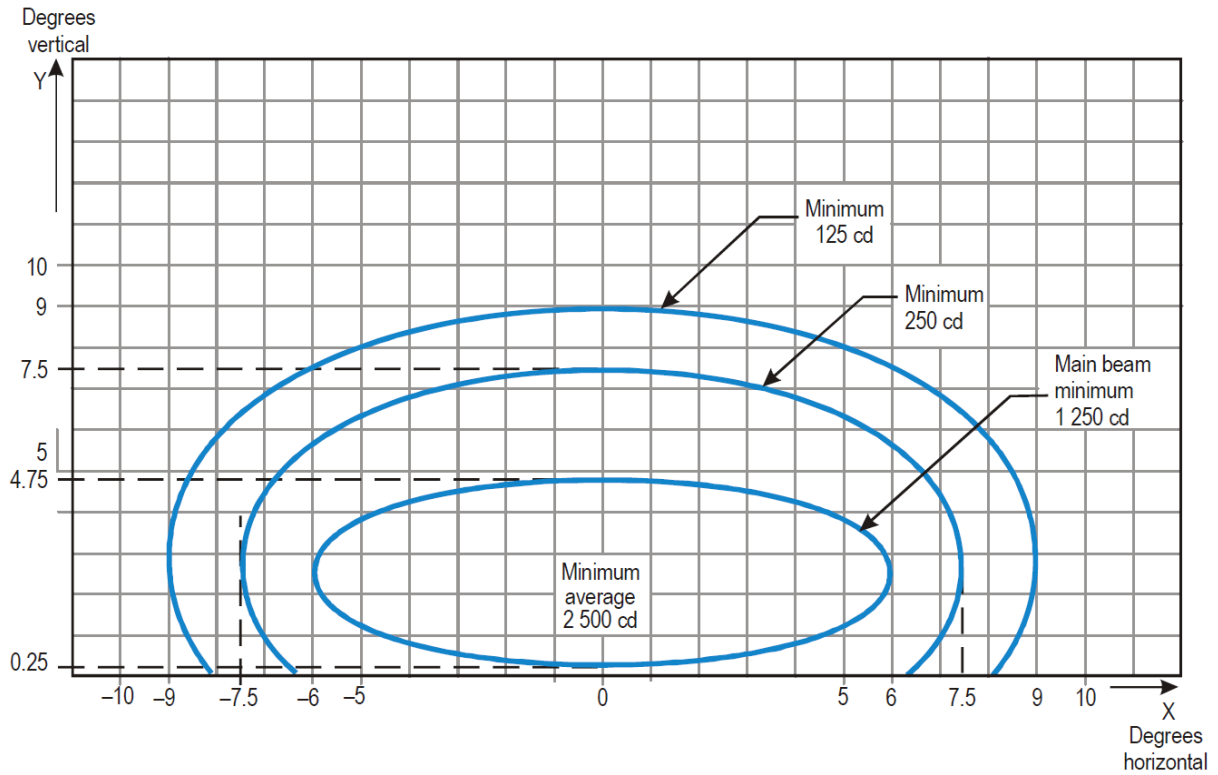

Notes:

1. Curves calculated on formula  $x$

$$\frac{x^2}{a^2} + \frac{y^2}{b^2} = 1$$

a	6.0	7.5	9.0
b	2.25	5.0	6.5

2. See collective notes for Figures A3-1 to A3-11 and A3-26.

**Figure A3-8. Isocandela diagram for runway end light (red light)**

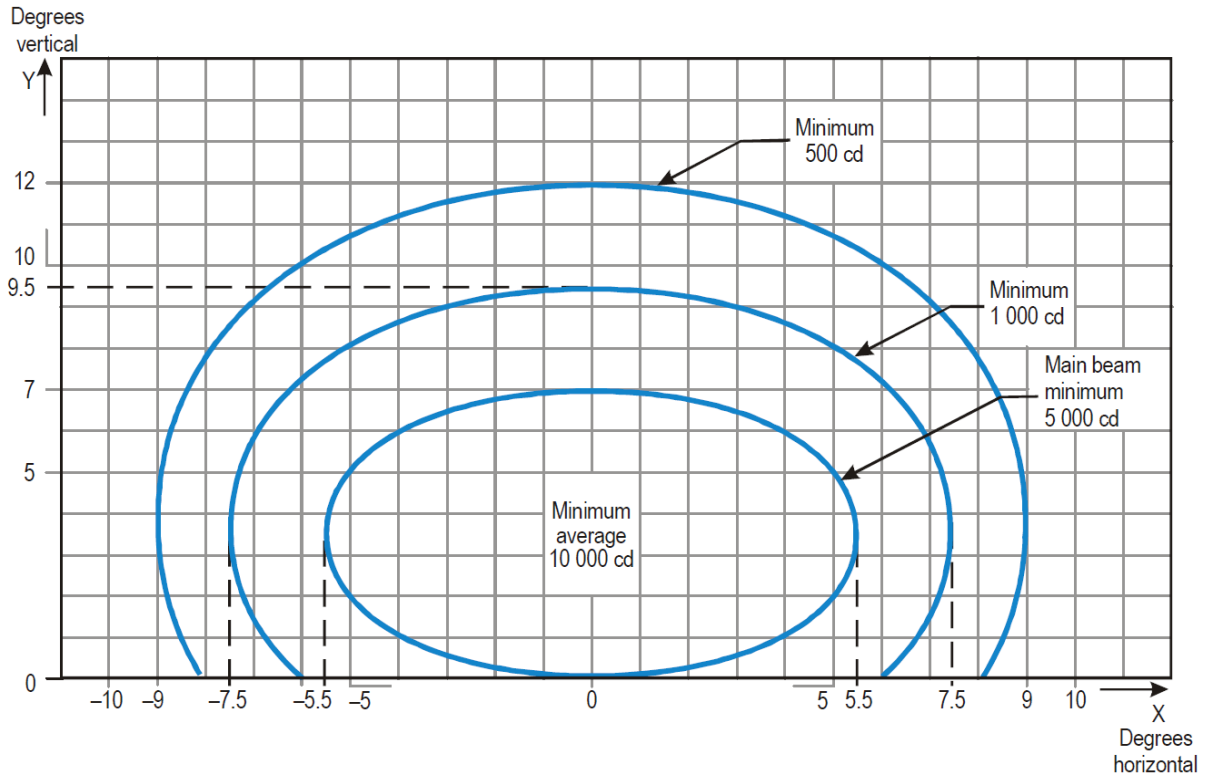

**Notes:**

1. Curves calculated on formula  $x$

$\frac{x^2}{a^2} + \frac{y^2}{b^2} = 1$	a	5.5	7.5	9.0
	b	3.5	6.0	8.5

2. Toe-in 3.5 degrees
3. For red light, multiply values by 0.15.
4. For yellow light, multiply values by 0.40.
5. See collective notes for Figures A3-1 to A3-11 and A3-26.

**Figure A3-9. Isocandela diagram for runway edge light where width of runway is 45 m (white light)**

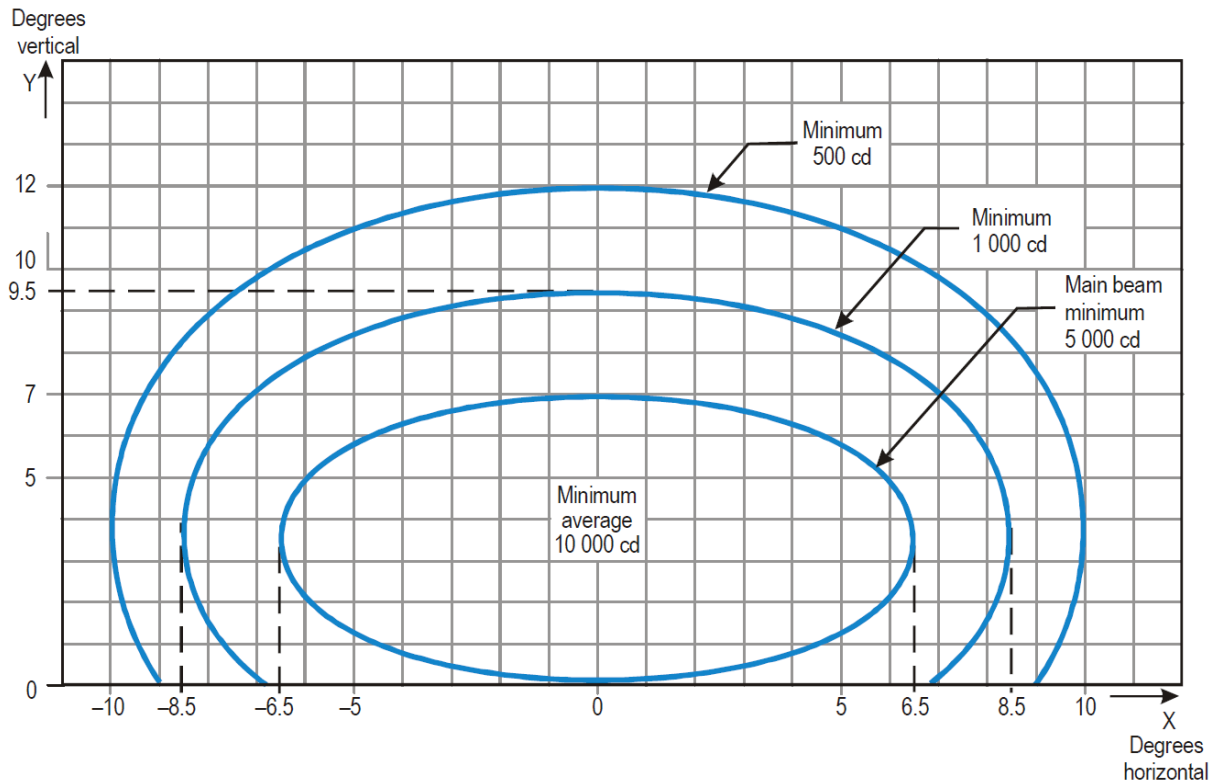

Notes:

1. Curves calculated on formula  $x$

$$\frac{x^2}{a^2} + \frac{y^2}{b^2} = 1$$

a	6.5	8.5	10.0
b	3.5	6.0	8.5

2. Toe-in 4.5 degrees

3. For red light, multiply values by 0.15.

4. For yellow light, multiply values by 0.40.

5. See collective notes for Figures A3-1 to A3-11 and A3-26.

**Figure A3-10. Isocandela diagram for runway edge light where width of runway is 60m (white light)**

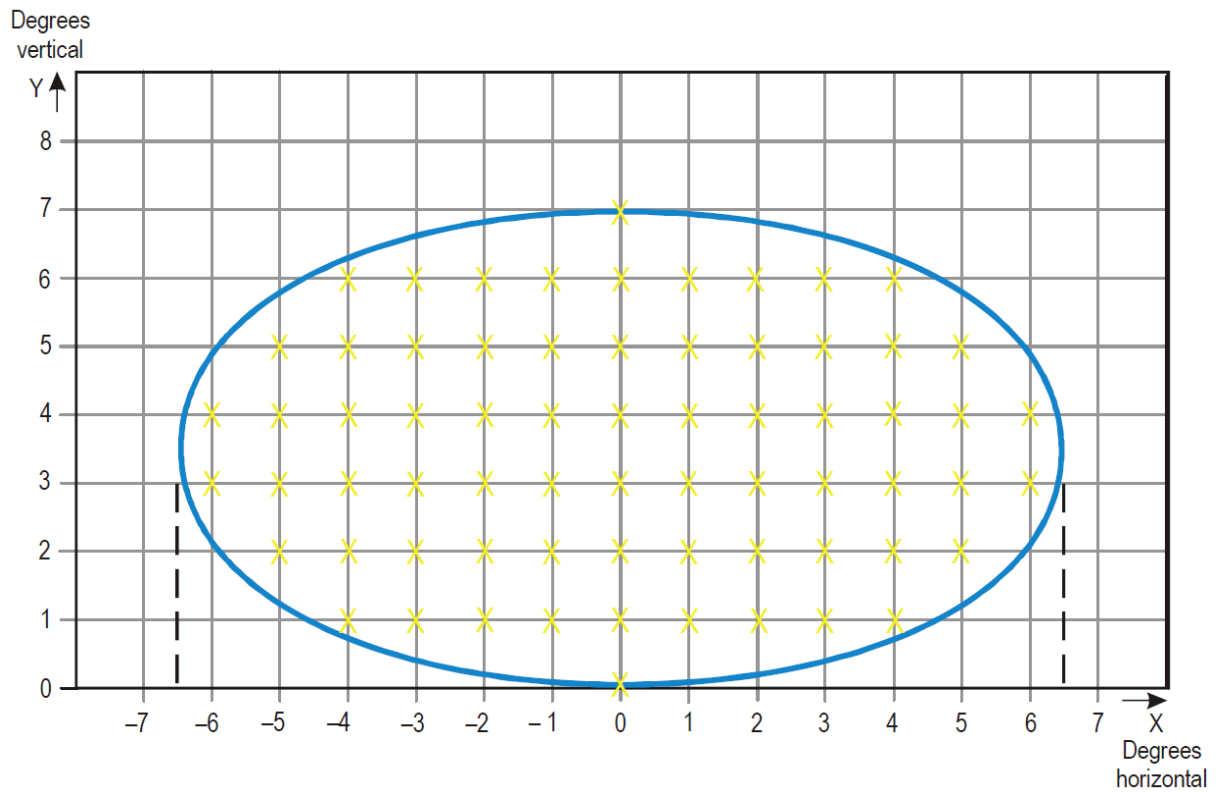

**Figure A3-11. Grid points to be used for the calculation of average intensity of approach and runway lights**

*Collective notes to Figures A3-1 to A3-11 and A3-26*

1. The ellipses in each figure are symmetrical about the common vertical and horizontal axes.
2. Figures A3-1 to A3-10, as well as Figure A3-26, show the minimum allowable light intensities. The average intensity of the main beam is calculated by establishing grid points as shown in Figure A3-11 and using the intensity value measures at all grid points located within and on the perimeter of the ellipse representing the main beam. The average value is the arithmetic average of light intensities measured at all considered grid points.
3. No deviations are acceptable in the main beam pattern when the lighting fixture is properly aimed.
4. Average intensity ratio. The ratio between the average intensity within the ellipse defining the main beam of a typical new light and the average light intensity of the main beam of a new runway edge light must be as follows:

Figure A3-1	Approach centre line and crossbars	1.5 to 2.0 (white light)
Figure A3-2	Approach side row	0.5 to 1.0 (red light)
Figure A3-3	Threshold	1.0 to 1.5 (green light)
Figure A3-4	Threshold wing bar	1.0 to 1.5 (green light)
Figure A3-5	Touchdown zone	0.5 to 1.0 (white light)
Figure A3-6	Runway centre line (longitudinal spacing 30 m)	0.5 to 1.0 (white light)
Figure A3-7	Runway centre line (longitudinal spacing 15 m)	0.5 to 1.0 for CAT III (white light) 0.25 to 0.5 for CAT I, II (white light)
Figure A3-8	Runway end	0.25 to 0.5 (red light)
Figure A3-9	Runway edge (45 m runway width)	1.0 (white light)
Figure A3-10	Runway edge (60 m runway width)	1.0 (white light)

5. The beam coverages in the figures provide the necessary guidance for approaches down to an RVR of the order of 150 m and take-offs down to an RVR of the order of 100 m.
6. Horizontal angles are measured with respect to the vertical plane through the runway centre line. For lights other than centre line lights, the direction towards the runway centre line is considered positive. Vertical angles are measured with respect to the horizontal plane.
7. Where, for approach centre line lights and crossbars and for approach side row lights, inset lights are used in lieu of elevated lights, e.g. on a runway with a displaced threshold, the intensity requirements can be met by installing two or three fittings (lower intensity) at each position.
8. The importance of adequate maintenance cannot be overemphasized. The average intensity should never fall to a value less than 50 per cent of the value shown in the figures, and it should be the aim of airport authorities to maintain a level of light output close to the specified minimum average intensity.
9. The light unit must be installed so that the main beam is aligned within one-half degree of the specified requirement.

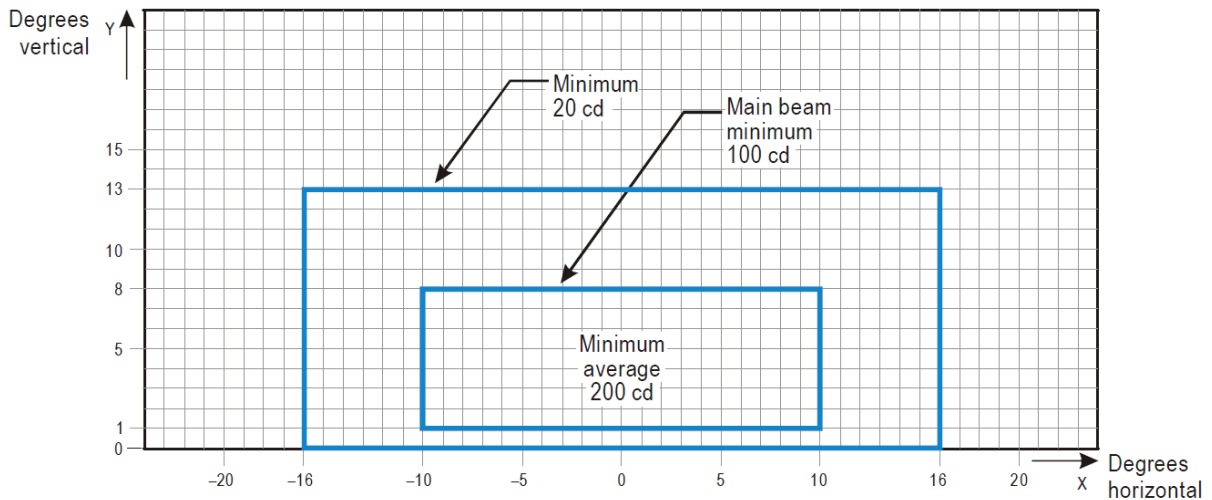

**Notes:**

1. These beam coverages allow for displacement of the cockpit from the centre line up to distances of the order of 12 m and are intended for use before and after curves.

2. See collective notes for Figures A3-12 to A3-21.

3. Increased intensities for enhanced rapid exit taxiway centre line lights are four times the respective intensities in the figure (i.e. 800 cd for minimum average main beam).

**Figure A3-12. Isocandela diagram for taxiway centre line (15 m spacing), RELs, no-entry bar and stop bar lights in straight sections intended for use in runway visual range conditions of less than a value of 350 m where large offsets can occur and for low-intensity runway guard lights, Configuration B**



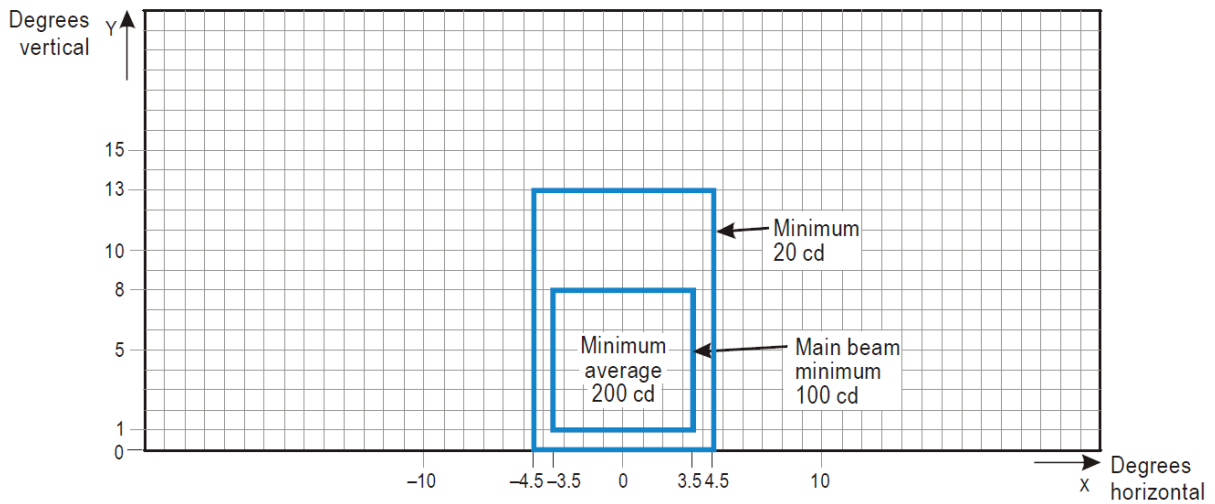

*Notes:*

1. *These beam coverages are generally satisfactory and cater for a normal displacement of the cockpit from the centre line of approximately 3 m.*
2. *See collective notes for Figures A3-12 to A3-21.*

**Figure A3-13. Isocandela diagram for taxiway centre line (15 m spacing), no-entry bar and stop bar lights in straight sections intended for use in runway visual range conditions of less than a value of 350 m**

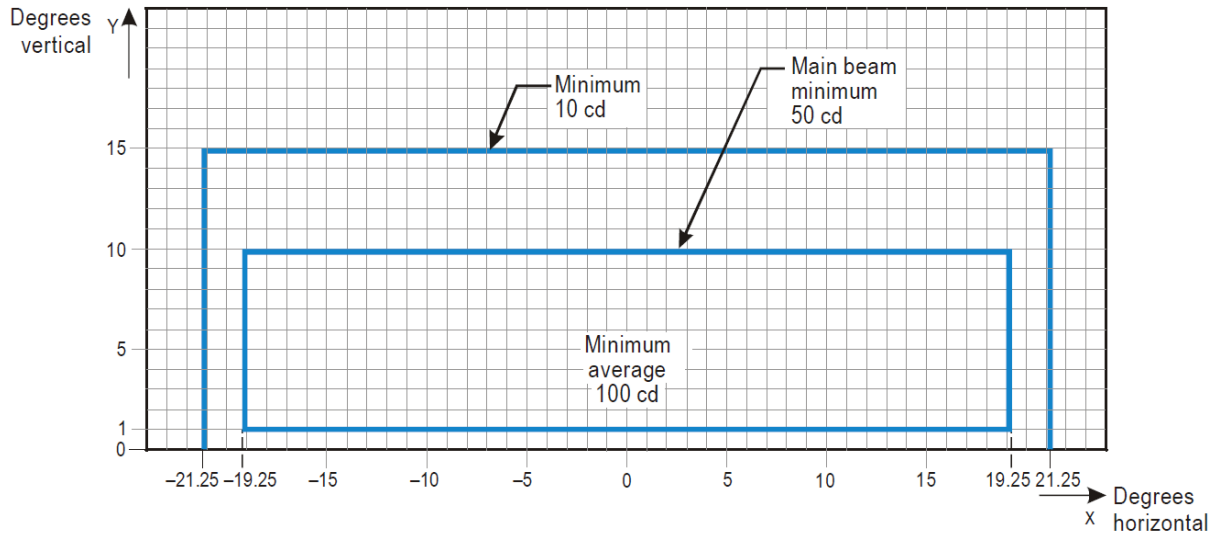

**Notes:**

1. Lights on curves to be toed-in 15.75 degrees with respect to the tangent of the curve. This does not apply to runway entrance lights (RELs)
2. Increased intensities for RELs must be twice the specified intensities, i.e., minimum 20 cd, main beam minimum 100 cd and minimum average 200 cd.
3. See collective notes for Figures A3-12 to A3-21.

**Figure A3-14. Isocandela diagram for taxiway centre line (7.5 m spacing), RELs, no-entry bar and stop bar lights in curved sections intended for use in runway visual range conditions of less than a value of 350 m**

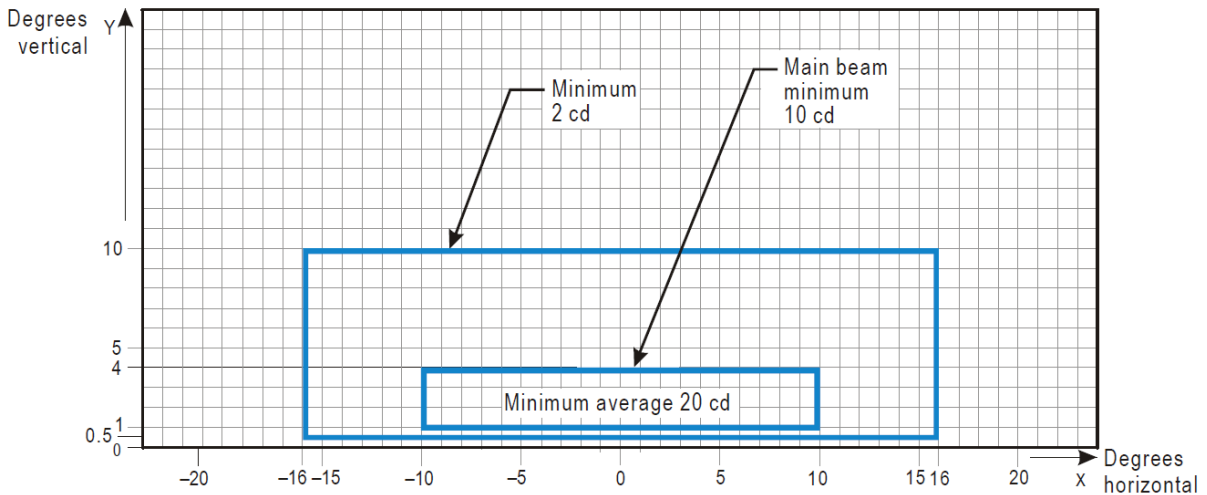

**Notes:**

1. At locations where high background luminance is usual and where deterioration of light output resulting from dust, snow and local contamination is a significant factor, the cd values should be multiplied by 2.5.
2. Where omnidirectional lights are used they must comply with the vertical beam requirements in this figure.
3. See collective notes for Figures A3-12 to A3-21.

**Figure A3-15. Isocandela diagram for taxiway centre line (30 m, 60 m spacing), no-entry bar and stop bar lights in straight sections intended for use in runway visual range conditions of 350 m or greater**

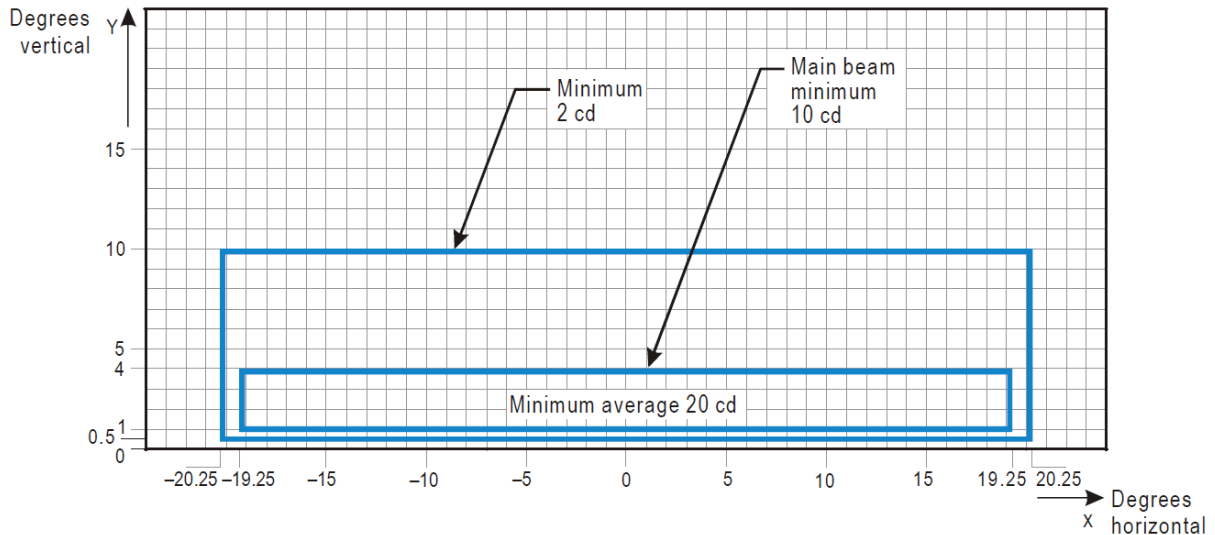

**Notes:**

1. Lights on curves to be toed-in 15.75 degrees with respect to the tangent of the curve.
2. At locations where high background luminance is usual and where deterioration of light output resulting from dust, snow and local contamination is a significant factor, the cd-values should be multiplied by 2.5.
3. These beam coverages allow for displacement of the cockpit from the centre line up to distances of the order of 12 m as could occur at the end of curves.
4. See collective notes for Figures A3-12 to A3-21.

**Figure A3-16. Isocandela diagram for taxiway centre line (7.5 m, 15 m, 30 m spacing), no-entry bar and stop bar lights in curved sections intended for use in runway visual range conditions of 350 m or greater**

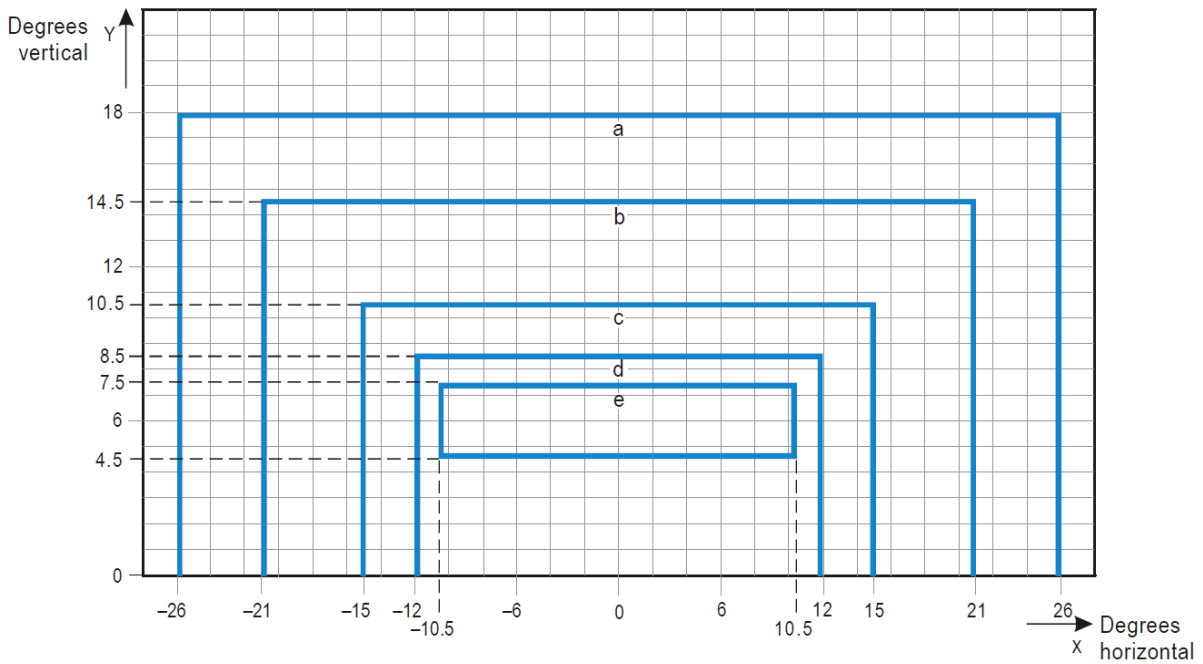

Curve	a	b	c	d	e
Intensity (cd)	8	20	100	450	1 800

*Notes:*

1. These beam coverages allow for displacement of the cockpit from the centre line up to distances of the order of 12 m and are intended for use before and after curves.

2. See collective notes for Figures A3-12 to A3-21.

**Figure A3-17. Isocandela diagram for high-intensity taxiway centre line (15 m spacing), no-entry bar and stop bar lights in straight sections intended for use in an advanced surface movement guidance and control system where higher light intensities are required and where large offsets can occur**

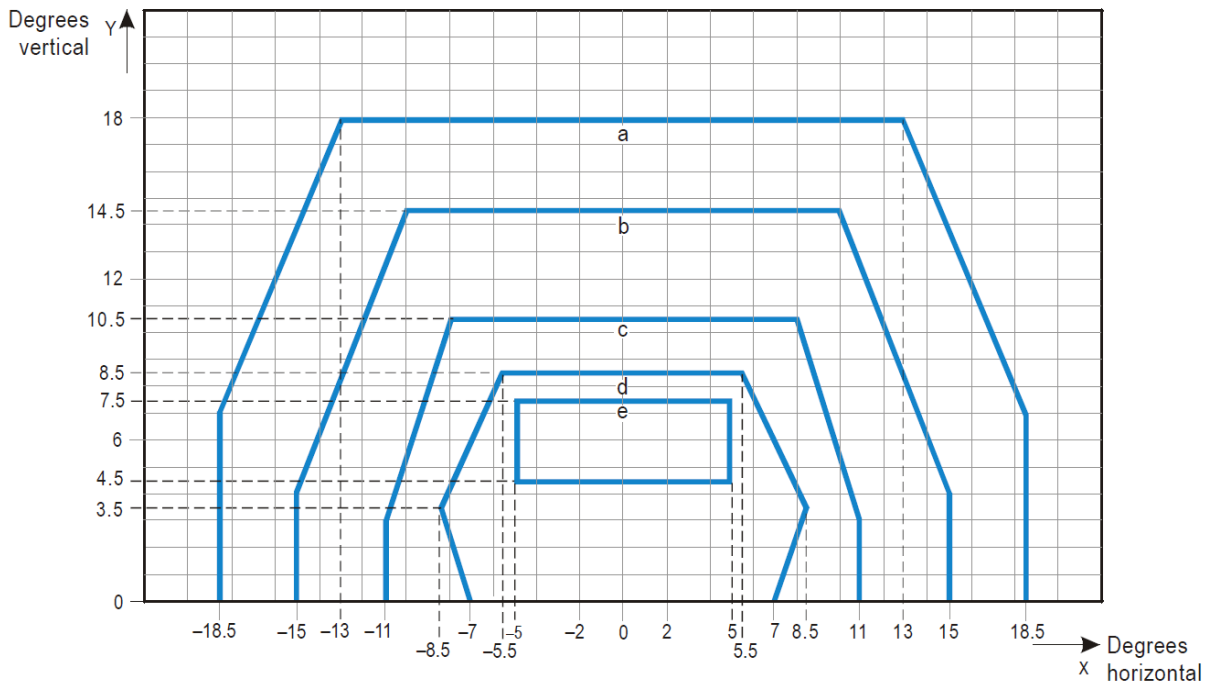

Curve	a	b	c	d	e
Intensity (cd)	8	20	100	450	1 800

**Notes:**

1. These beam coverages are generally satisfactory and cater for a normal displacement of the cockpit corresponding to the outer main gear wheel on the taxiway edge.

2. See collective notes for Figures A3-12 to A3-21.

**Figure A3-18. Isocandela diagram for high-intensity taxiway centre line (15m spacing), no-entry bar and stop bar lights in straight sections intended for use in an advanced surface movement guidance and control system where higher light intensities are required**

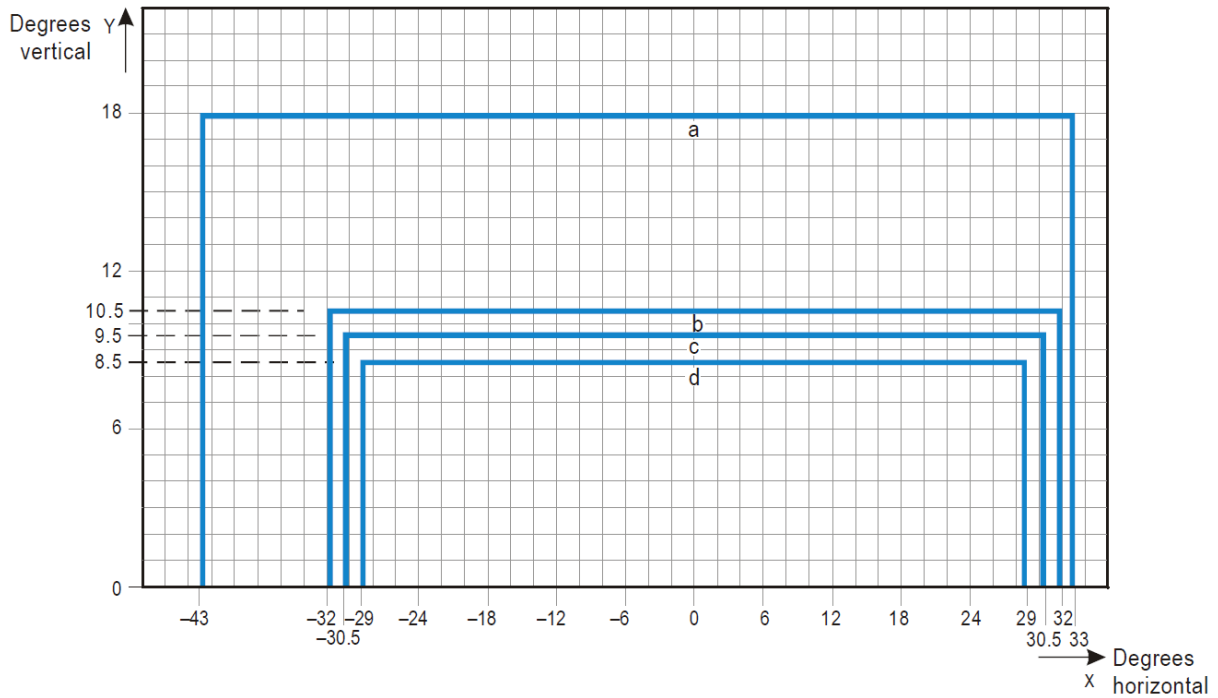

Curve	a	b	c	d
Intensity (cd)	8	100	200	400

Notes:

1. Lights on curves to be toed-in 17 degrees with respect to the tangent of the curve.
2. See collective notes for Figures A3-12 to A3-21.

**Figure A3-19. Isocandela diagram for high-intensity taxiway centre line (7.5 m spacing), no-entry bar and stop bar lights in curved sections intended for use in an advanced surface movement guidance and control system where higher light intensities are required**

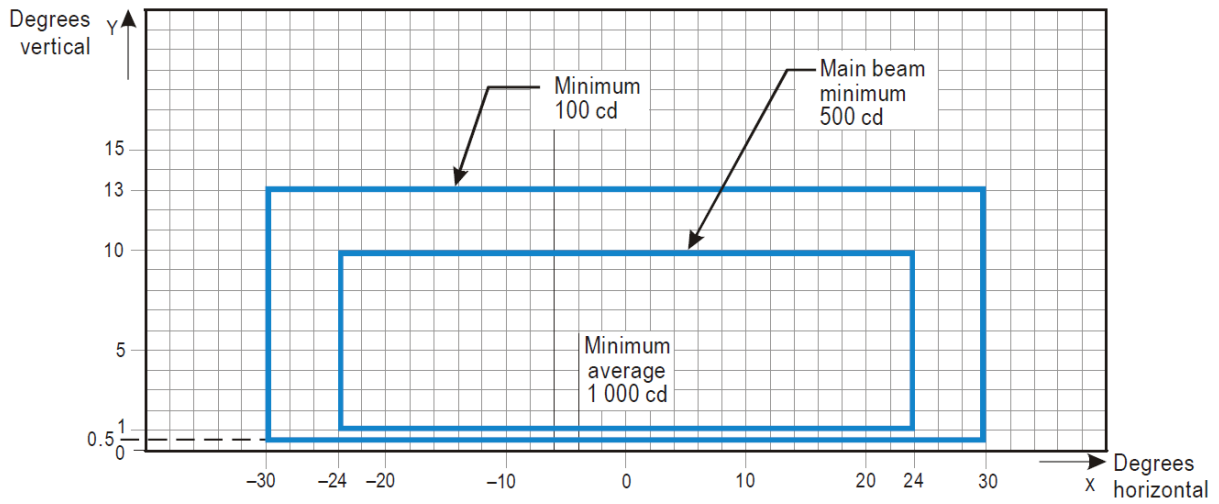

**Notes:**

1. Although the lights flash in normal operation, the light intensity is specified as if the lights were fixed for incandescent lamps.
2. See collective notes for Figures A3-12 to A3-21.

**Figure A3-20. Isocandela diagram for high-intensity runway guard lights, Configuration B**



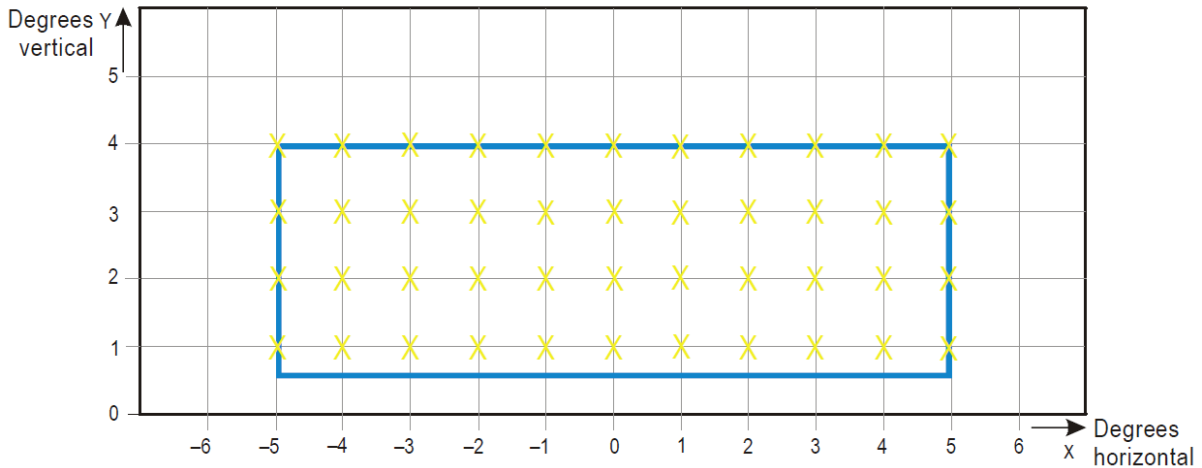

**Figure A3-21. Grid points to be used for calculation of average intensity of taxiway centre line and stop bar lights**

*Collective notes to Figures A3-12 to A3-21*

1. The intensities specified in Figures A3-12 to A3-20 are in green and yellow light for taxiway centre line lights, yellow light for runway guard lights and red light for stop bar lights.
2. Figures A3-12 to A3-20 show the minimum allowable light intensities. The average intensity of the main beam is calculated by establishing grid points as shown in Figure A3-21 and using the intensity values measured at all grid points located within and on the perimeter of the rectangle representing the main beam. The average value is the arithmetic average of the light intensities measured at all considered grid points.
3. No deviations are acceptable in the main beam or in the innermost beam, as applicable, when the lighting fixture is properly aimed.
4. Horizontal angles are measured with respect to the vertical plane through the taxiway centre line except on curves where they are measured with respect to the tangent to the curve.
5. Vertical angles are measured from the longitudinal slope of the taxiway surface.
6. The importance of adequate maintenance cannot be overemphasized. The intensity, either average where applicable or as specified on the corresponding isocandela curves, should never fall to a value less than 50 per cent of the value shown in the figures, and it should be the aim of airport authorities to maintain a level of light output close to the specified minimum average intensity.
7. The light unit must be installed so that the main beam or the innermost beam, as applicable, is aligned within one-half degree of the specified requirement.

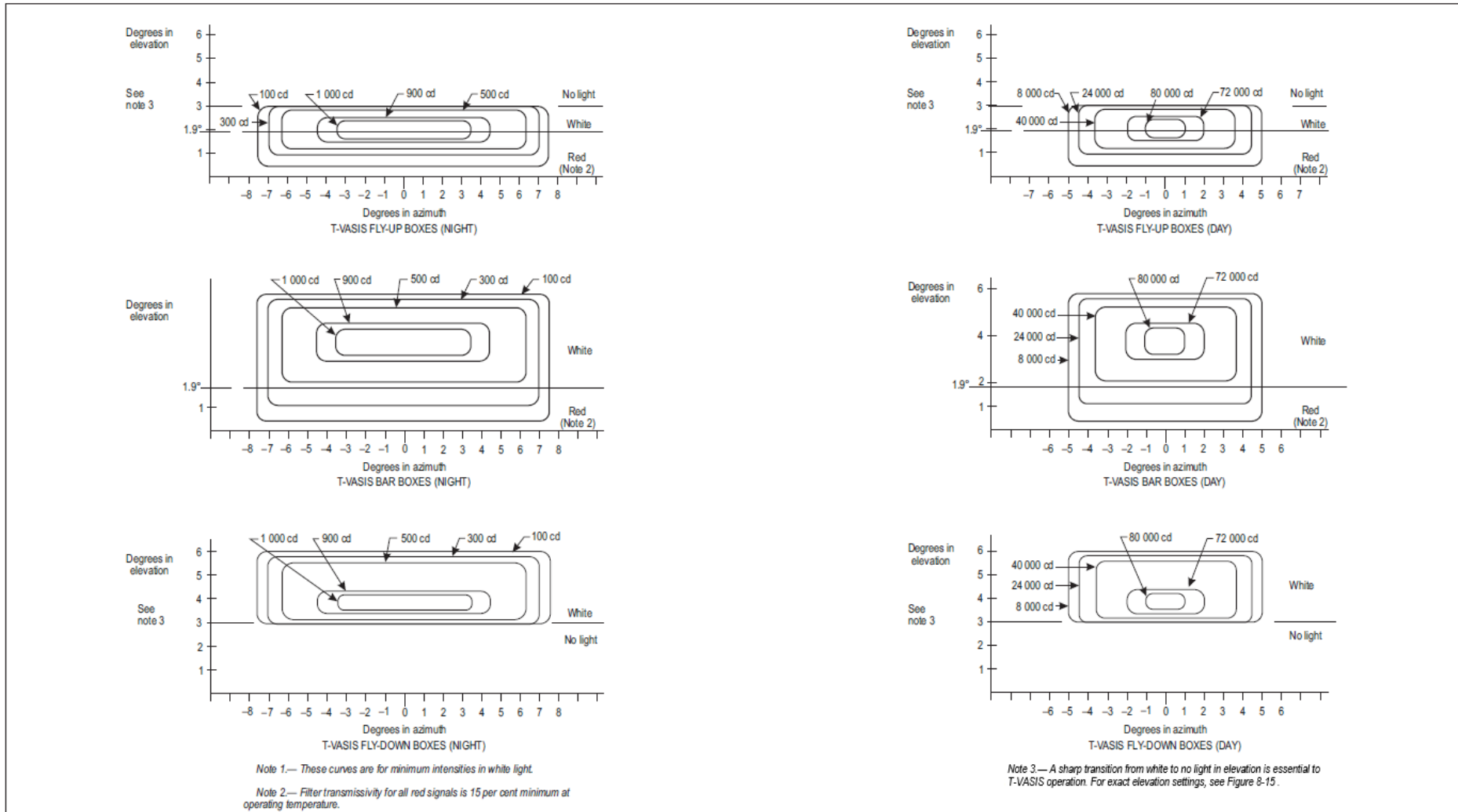
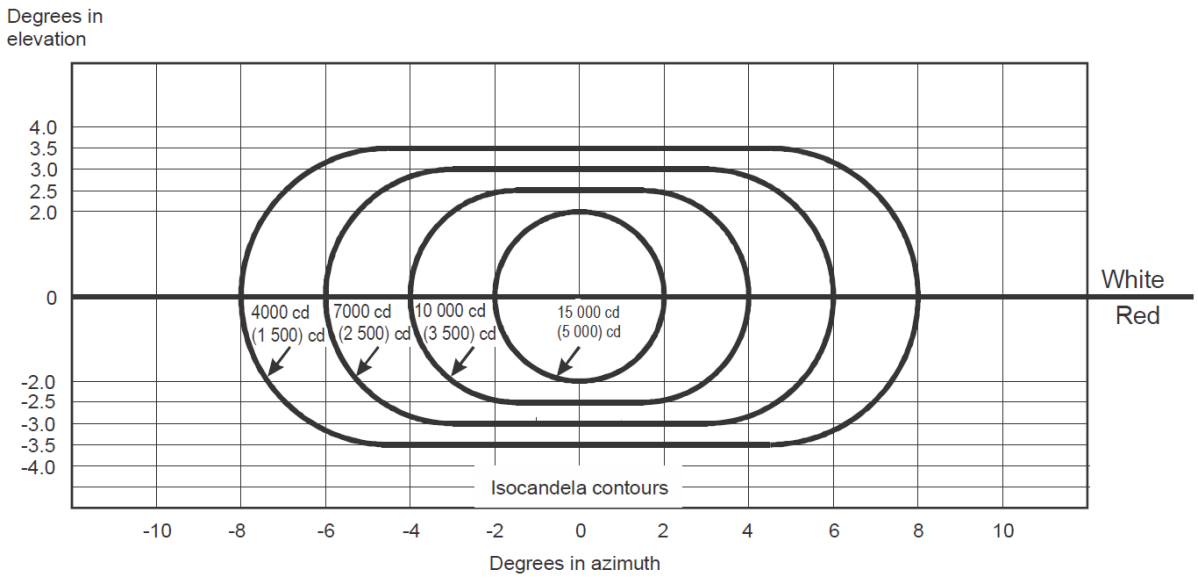

Figure A3-22. Light intensity distribution of T-VASIS and AT-VASIS



**Notes:**

1. *These curves are for minimum intensities in red light.*
2. *The intensity value in the white sector of the beam is no less than 2 and may be as high as 6.5 times the corresponding intensity in the red sector.*
3. *The intensity values shown in brackets are for APAPI.*

**Figure A3-23. Light intensity distribution of PAPI and APAPI**

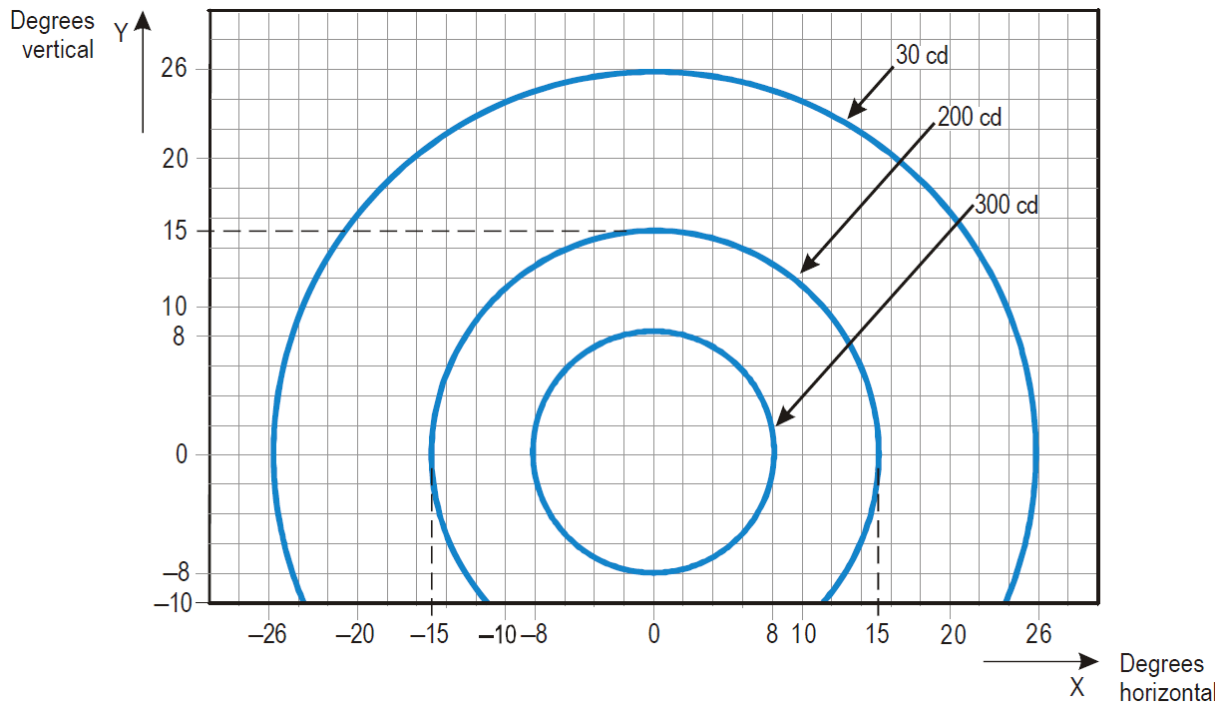

*Notes:*

1. *Although the lights flash in normal operation, the light intensity is specified as if the lights were fixed for incandescent lamps.*
2. *The intensities specified are in yellow light.*

**Figure A3-24. Isocandela diagram for each light in low-intensity runway guard lights, Configuration A**

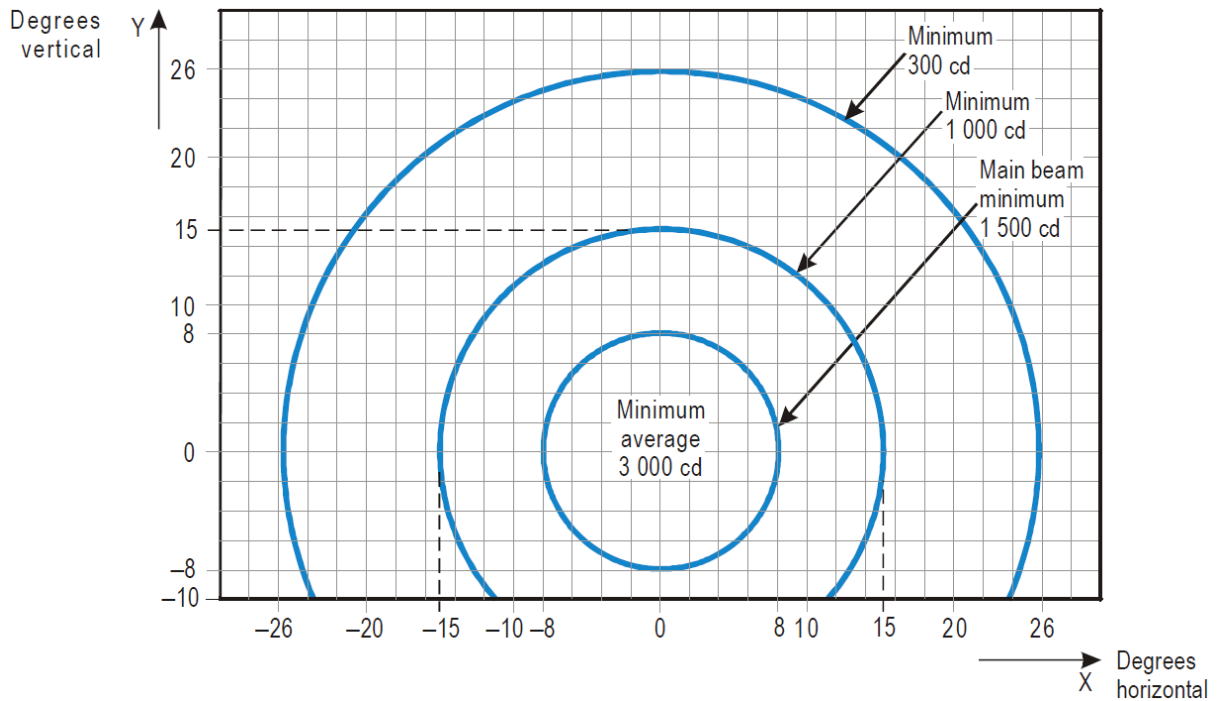

*Notes:*

1. *Although the lights flash in normal operation, the light intensity is specified as if the lights were fixed for incandescent lamps.*
2. *The intensities specified are in yellow light.*

**Figure A3-25. Isocandela diagram for each light in high-intensity runway guard lights, Configuration A**

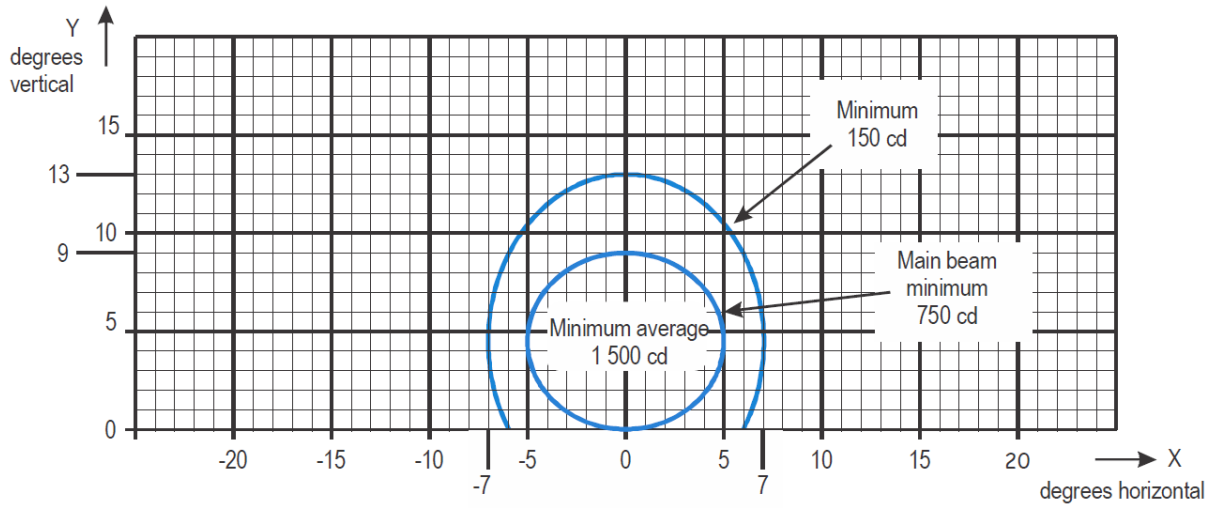

Notes:

1. Curves calculated on formula x

$$\frac{x^2}{a^2} + \frac{y^2}{b^2} = 1$$

a	5.0	7.0
b	4.5	8.5

2. See collective notes for Figures A3-1 to A3-11 and A3-26.

**Figure A3-26. Isocandela diagram for take-off and hold lights (THL) (red light)**

## Appendix 4 Mandatory instruction markings and information markings

1. This appendix details the form and proportions of the letters, numbers and symbols of mandatory instruction markings and information markings on a grid.
2. The mandatory instruction markings and information markings on pavements are formed as if shadowed (i.e., stretched) from the characters of an equivalent elevated sign by a factor of 2.5 as shown in Figure A4-1. The shadowing, however, only affects the vertical dimension. Therefore, the spacing of characters for pavement marking is obtained by first determining the equivalent elevated sign character height and then proportioning from the spacing values given in Table A5-1. For example, in the case of the runway designator "10" which is to have a height of 4 000 mm ( $H_{ps}$ ), the equivalent elevated sign character height is  $4\ 000/2.5=1\ 600$  mm ( $H_{es}$ ).
3. Table A5-1(b) indicates numeral to numeral code 1 and from Table A5-1(c) this code has a dimension of 96 mm, for a character height of 400 mm. The pavement marking spacing for "10" is then  $(1\ 600/400)*96=384$  mm.

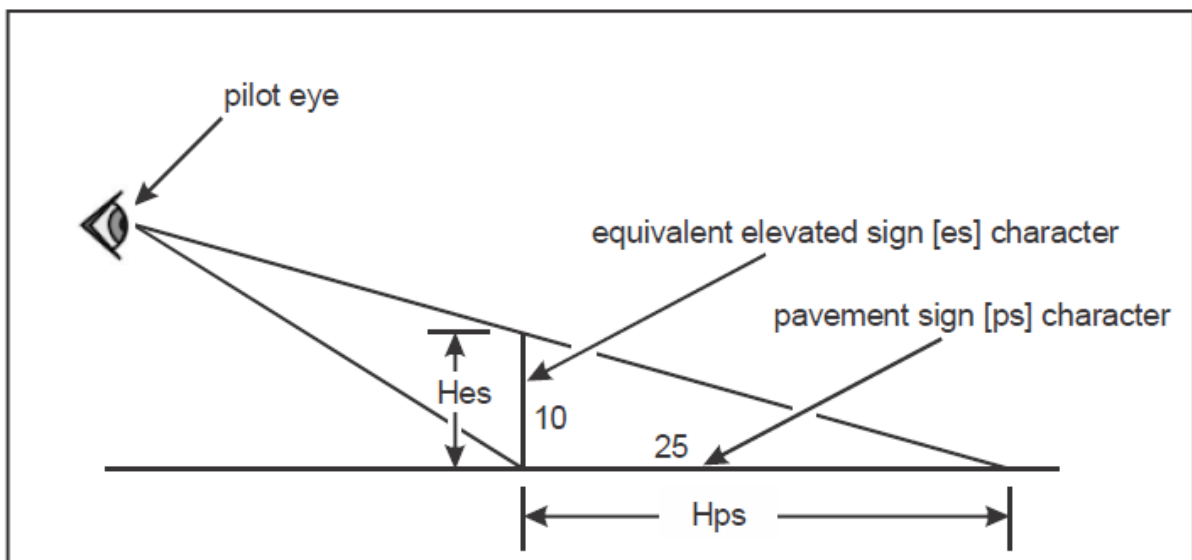
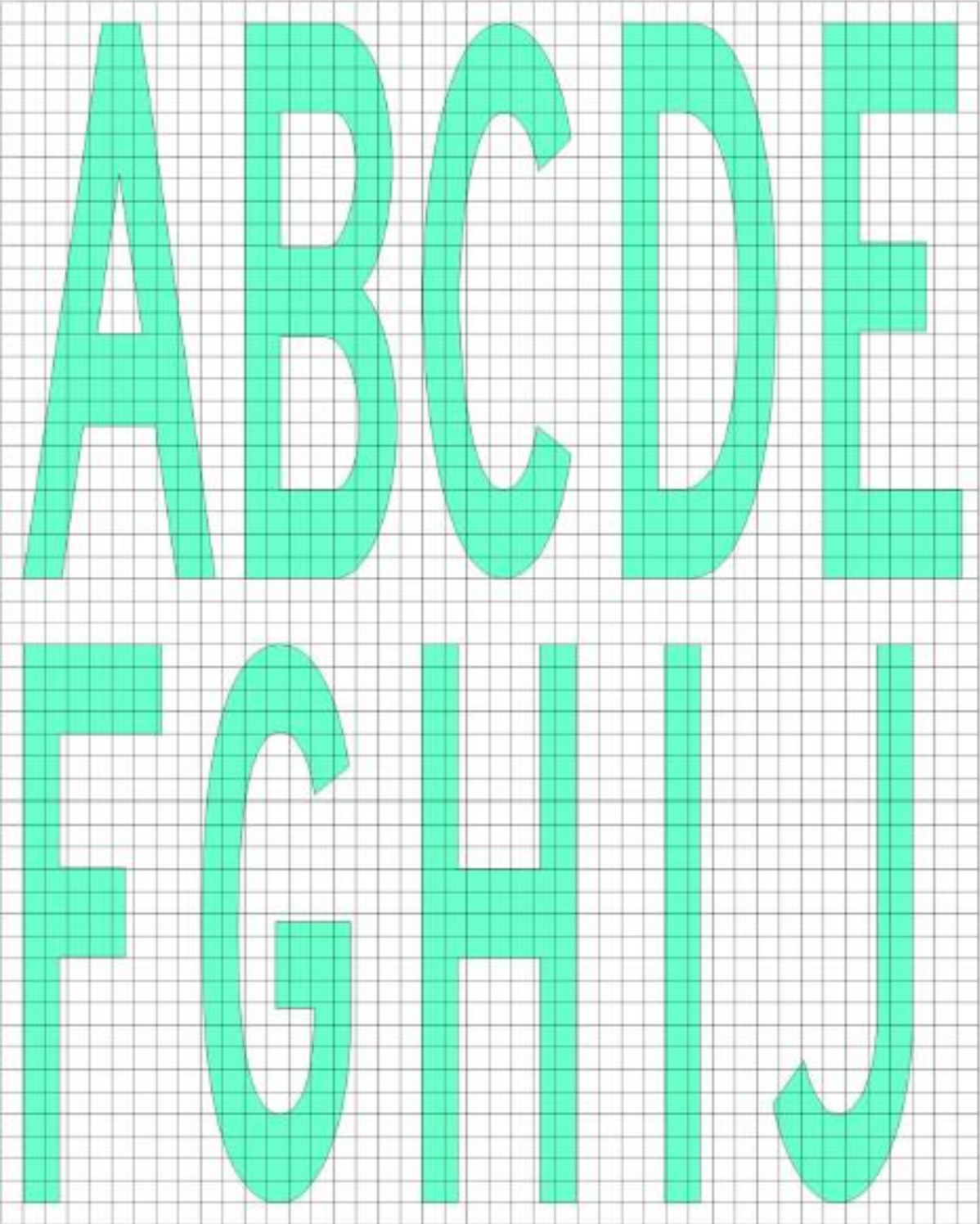
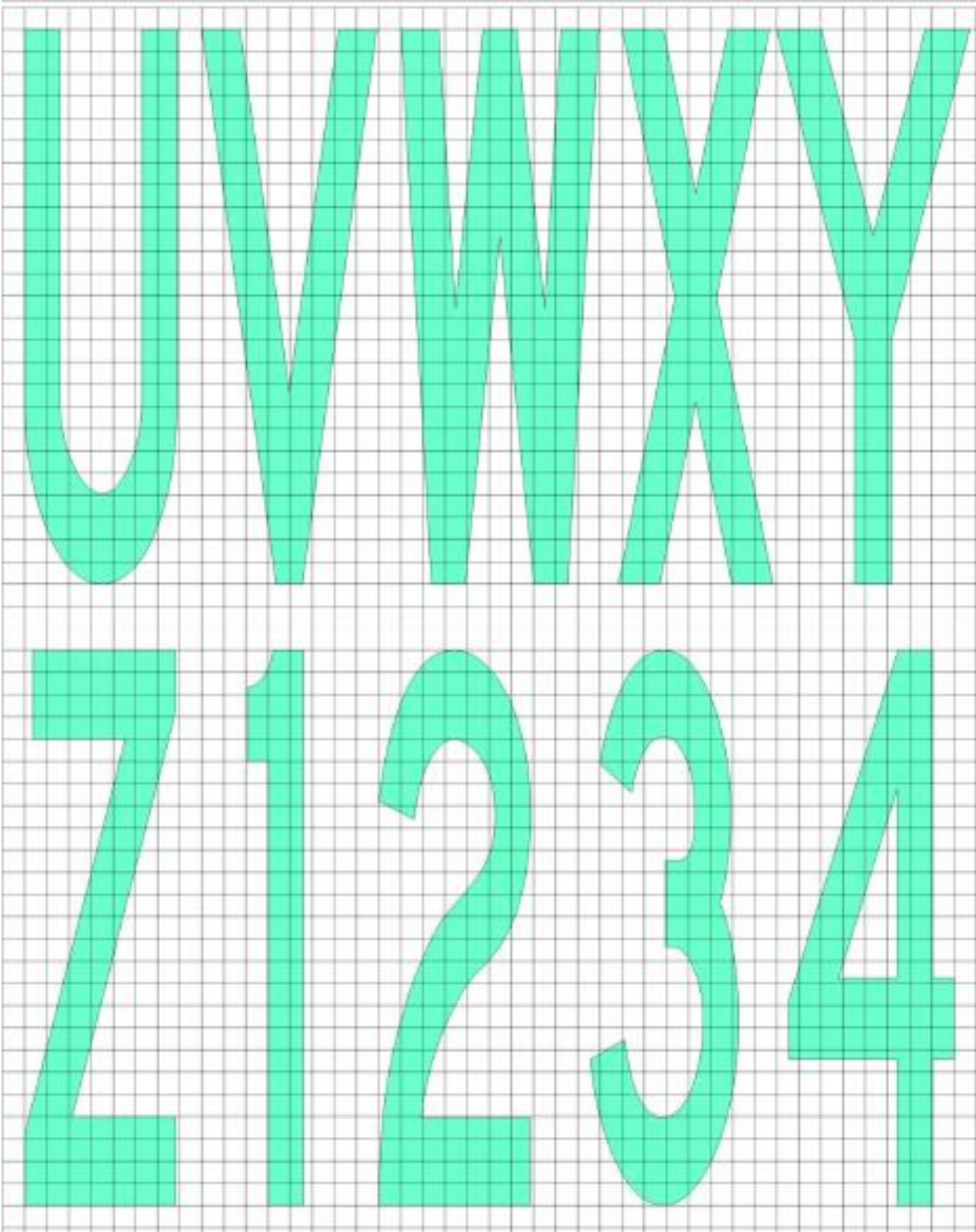

Figure A4 - 1









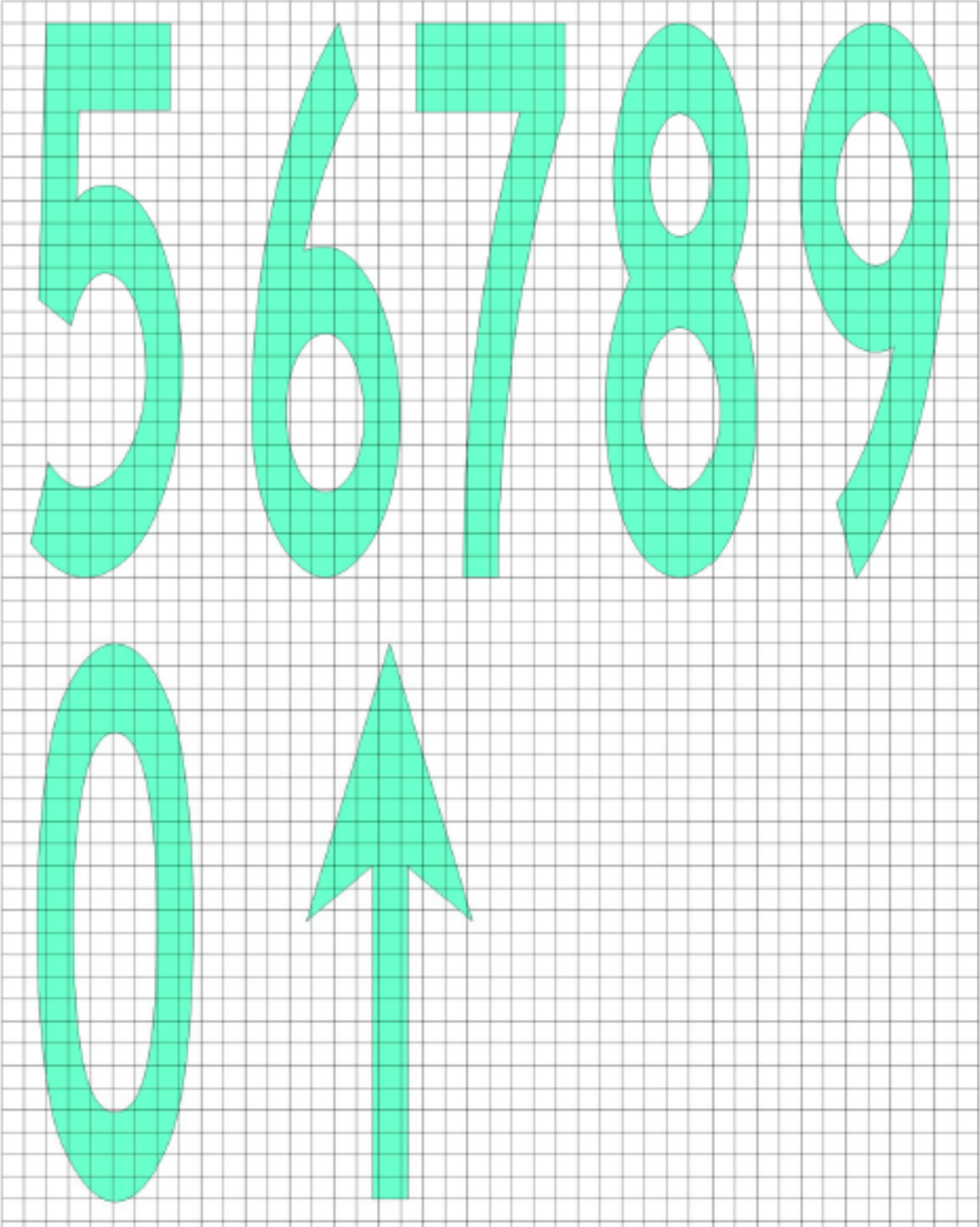

## Appendix 5 Requirements concerning design of taxiing guidance signs

1. Inscription heights must conform to the following tabulation.

Runway code number	Minimum character height		
	Mandatory instruction sign	Information sign	
		Runway exit and runway vacated signs	Other signs
1 or 2	300 mm	300 mm	200 mm
3 or 4	400 mm	400 mm	300 mm

*Note.— Where a taxiway location sign is installed in conjunction with a runway designation sign, the character size must be that specified for mandatory instruction signs.*

2. Arrow dimensions must be as follows:

<i>Legend height</i>	<i>Stroke</i>
200 mm	32 mm
300 mm	48 mm
400 mm	64 mm

3. Stroke width for single letter must be as follows:

<i>Legend height</i>	<i>Stroke</i>
200 mm	32 mm
300 mm	48 mm
400 mm	64 mm

4. Sign luminance must be as follows:

- (a) Where operations are conducted in runway visual range conditions less than a value of 800m, average sign luminance must be at least:

Red	30 cd/m <sup>2</sup>
Yellow	150 cd/m <sup>2</sup>
White	300 cd/m <sup>2</sup>

- (b) Where operations are conducted in accordance with paragraphs 8.4.1.6 (b) and (c) and 8.4.1.7, average sign luminance<sup>189</sup> must be at least:

Red	10 cd/m <sup>2</sup>
Yellow	50 cd/m <sup>2</sup>
White	100 cd/m <sup>2</sup>

<sup>189</sup> In runway visual range conditions less than a value of 400 m, there will be some degradation in the performance of signs.

5. The luminance ratio between red and white elements of a mandatory sign must be between 1:5 and 1:10.
6. The average luminance of the sign is calculated by establishing grid points as shown in Figure A5-1 and using the luminance values measured at all grid points located within the rectangle representing the sign.
7. The average value is the arithmetic average of the luminance values measured<sup>190</sup> at all considered grid points.
8. The ratio between luminance values of adjacent grid points must not exceed 1.5:1. For areas on the sign face where the grid spacing is 7.5 cm, the ratio between luminance values of adjacent grid points must not exceed 1.25:1. The ratio between the maximum and minimum luminance value over the whole sign face must not exceed 5:1.
9. The forms of characters, i.e. letters, numbers, arrows and symbols, must conform to those shown in Figure A5-2. The width of characters and the space between individual characters must be determined as indicated in Table A5-1.

10. The face height of signs must be as follows:

<i>Legend height</i>	<i>Face height (min)</i>
200 mm	300 mm
300 mm	450 mm
400 mm	600 mm

11. The face width of signs must be determined<sup>191</sup> using Figure A5-4 except that, where a mandatory instruction sign is provided on one side of a taxiway only, the face width must not be less than:
  - (a) 1.94 m where the code number is 3 or 4; and
  - (b) 1.46 m where the code number is 1 or 2.
12. Borders
  - (a) The black vertical delineator between adjacent direction signs should have a width of approximately 0.7 of the stroke width.
  - (b) The yellow border on a stand-alone location sign should be approximately 0.5 stroke width.
13. The colours of signs must be in accordance with the appropriate specifications in Appendix 2.

---

<sup>190</sup> Guidance on measuring the average luminance of a sign is contained in the ICAO Aerodrome Design Manual (Doc 9157), Part 4

<sup>191</sup> Additional guidance on determining the face width of a sign is contained in the ICAO Aerodrome Design Manual (Doc 9157), Part 4.

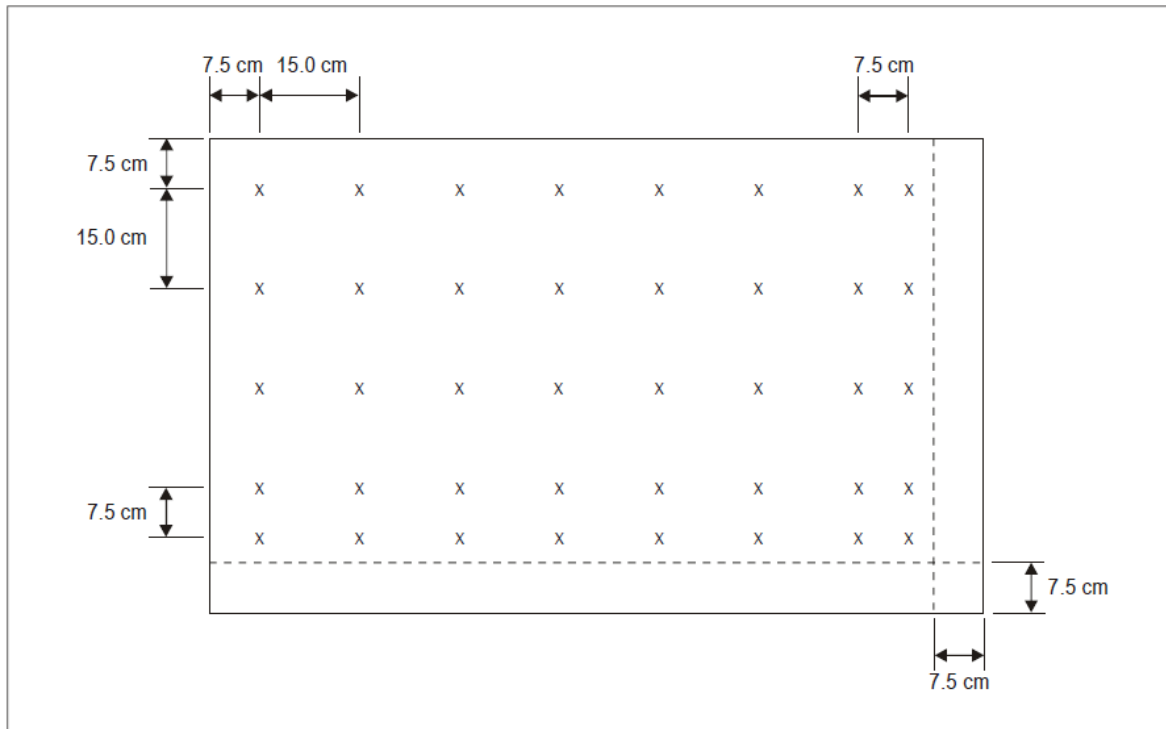

Note 1.— The average luminance of a sign is calculated by establishing grid points on a sign face showing typical inscriptions and a background of the appropriate colour (red for mandatory instruction signs and yellow for direction and destination signs) as follows:

- Starting at the top left corner of the sign face, establish a reference grid point at 7.5 cm from the left edge and the top of the sign face.
- Create a grid of 15 cm spacing horizontally and vertically from the reference grid point. Grid points within 7.5 cm of the edge of the sign face must be excluded.
- Where the last point in a row/column of grid points is located between 22.5 cm and 15 cm from the edge of the sign face (but not inclusive), an additional point must be added 7.5 cm from this point.
- Where a grid point falls on the boundary of a character and the background, the grid point must be slightly shifted to be completely outside the character.

Note 2.— Additional grid points may be required to ensure that each character includes at least five evenly spaced grid points.

Note 3.— Where one unit includes two types of signs, a separate grid must be established for each type.]

**Figure A5-1. Grid points for calculating average luminance of a sign**

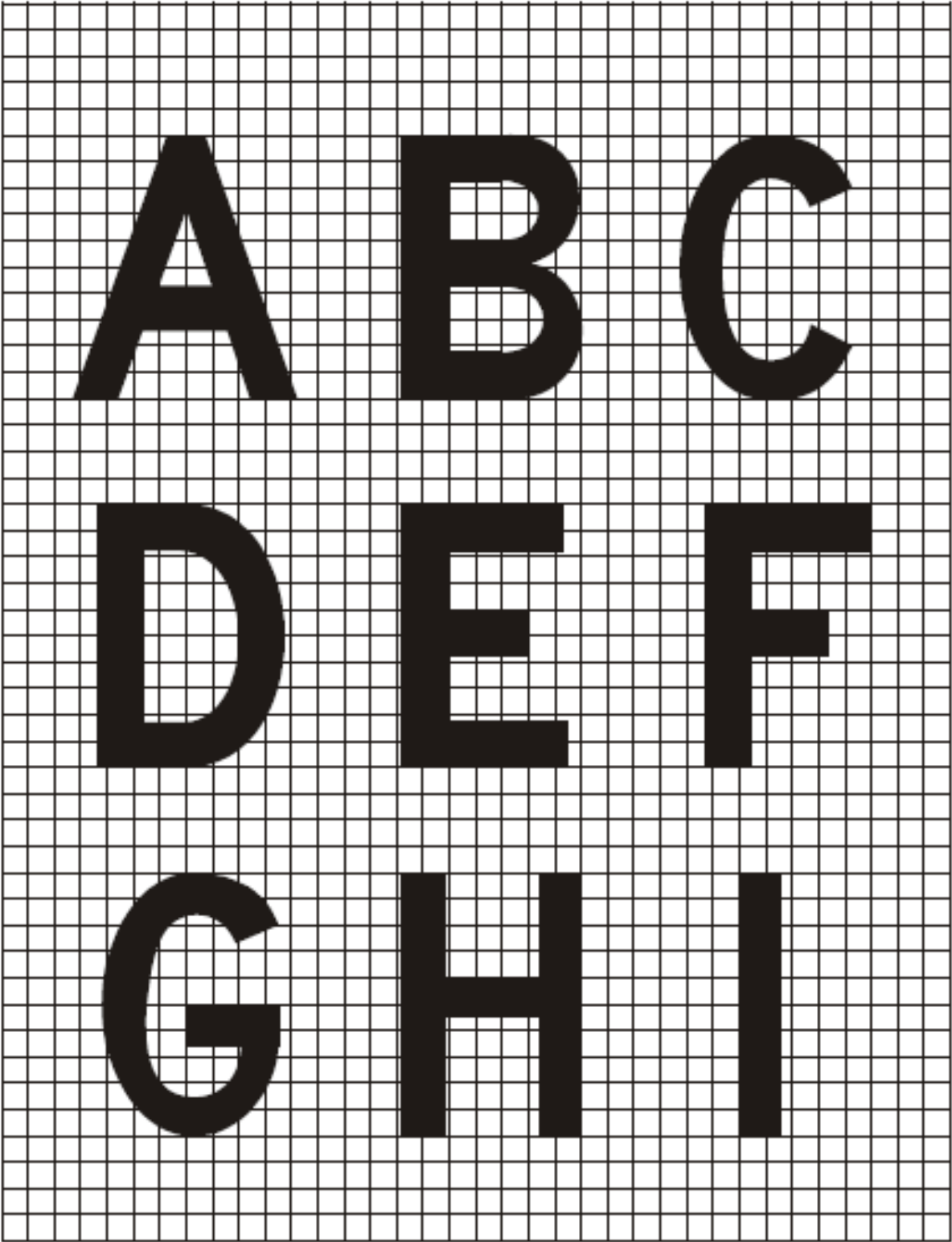

Figure A5-2. Forms of characters

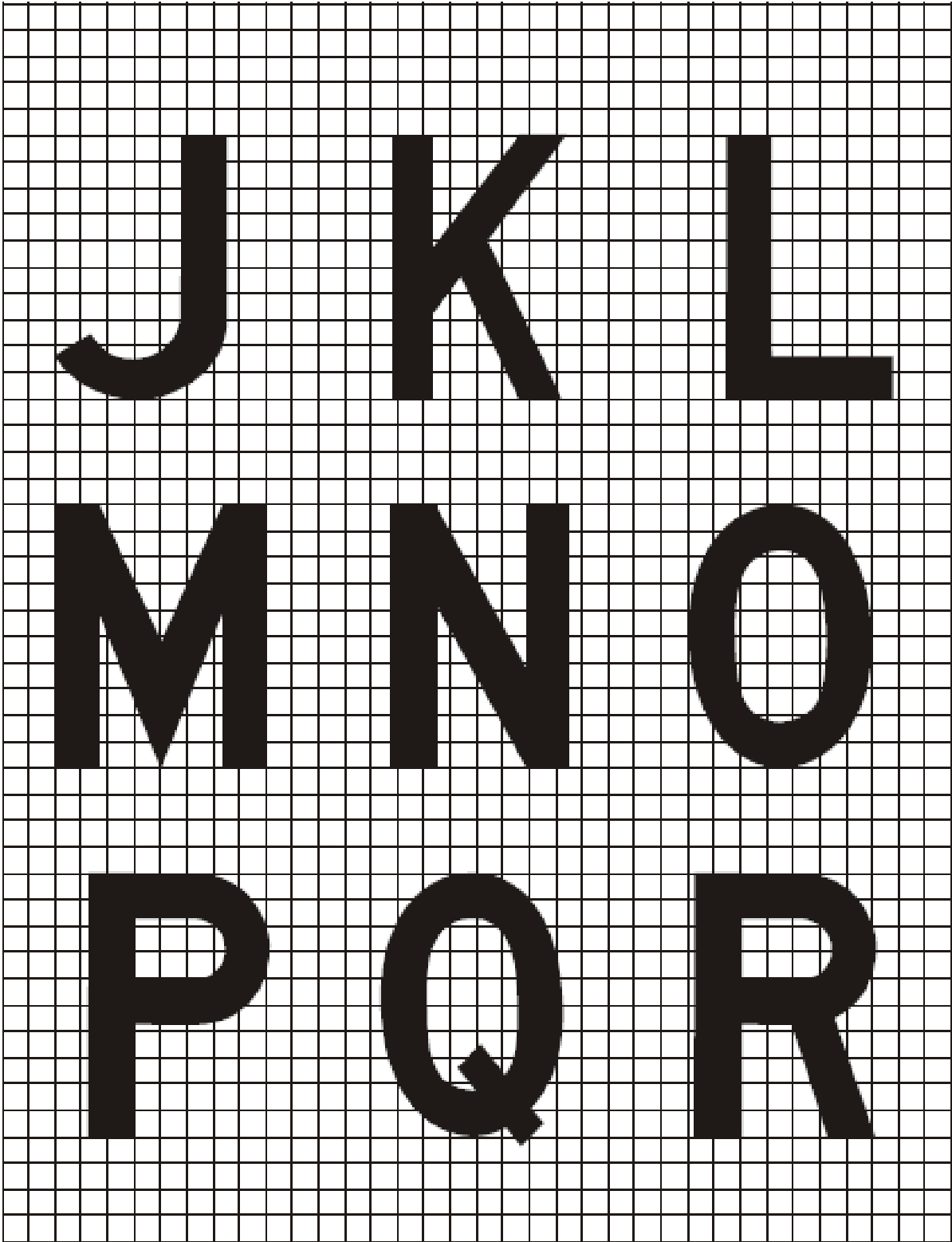

Figure A5-2. (cont.)



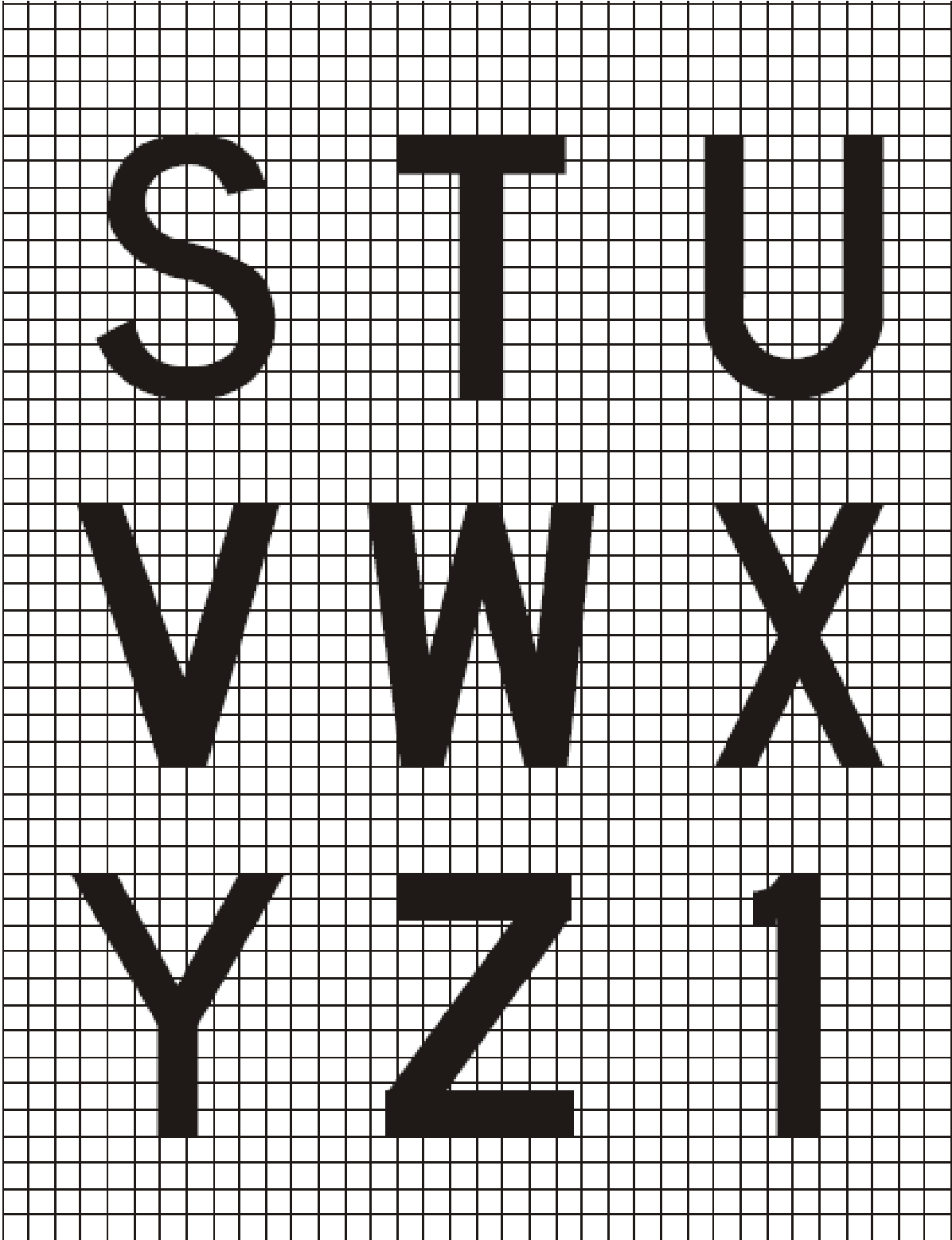
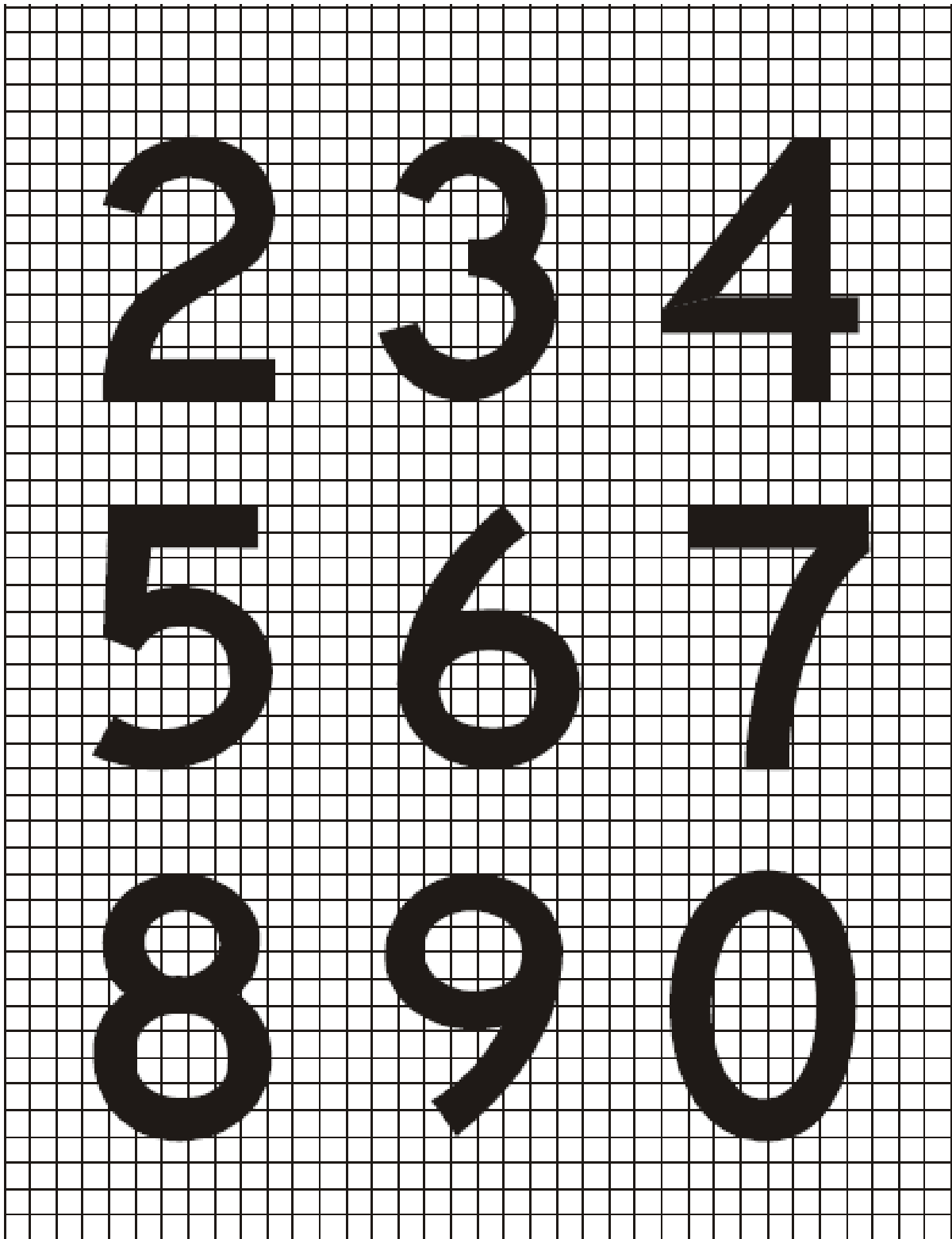

Figure A5-2. (cont.)



**Figure A5-2. (cont.)**

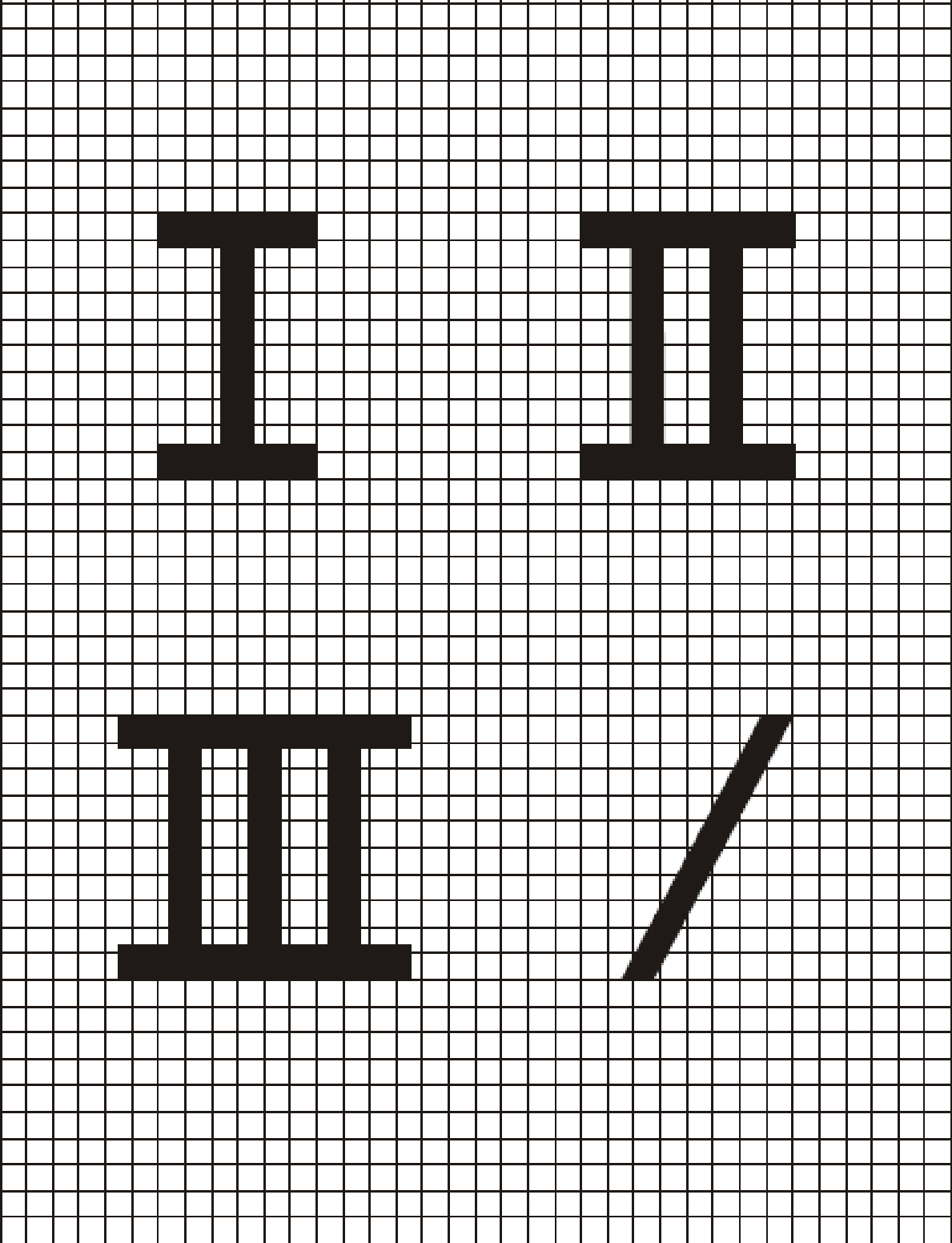
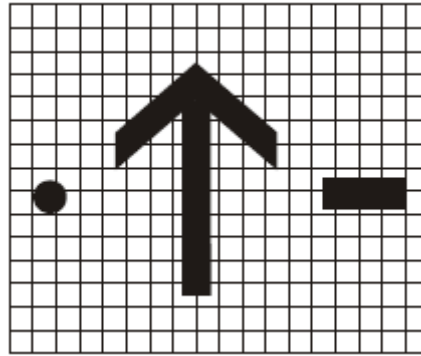

Figure A5-2. (cont.)



Arrow, dot and dash

Note 1.—The arrow stroke width, diameter of the dot, and both width and length of the dash must be proportioned to the character stroke widths.

Note 2.— The dimensions of the arrow must remain constant for a particular sign size, regardless of orientation.

Figure A5-2.

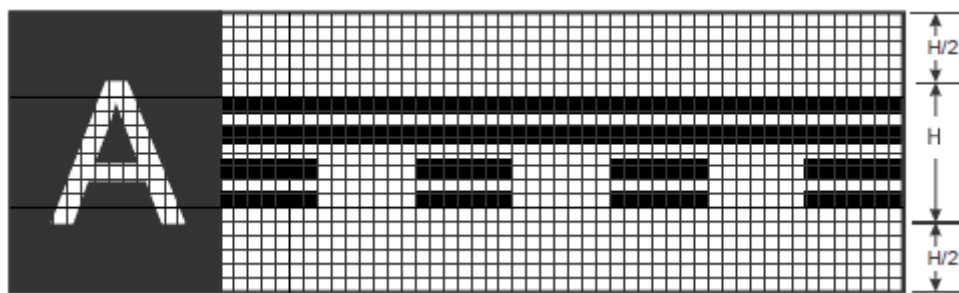

Runway vacated sign (with typical location sign)

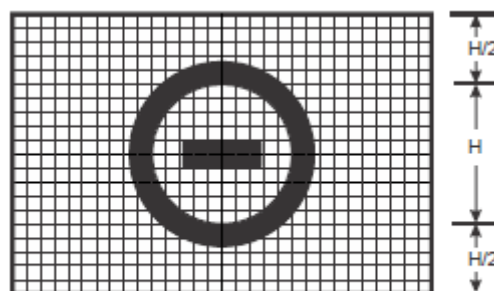

NO ENTRY sign

Figure A5-3. Runway vacated and NO ENTRY signs

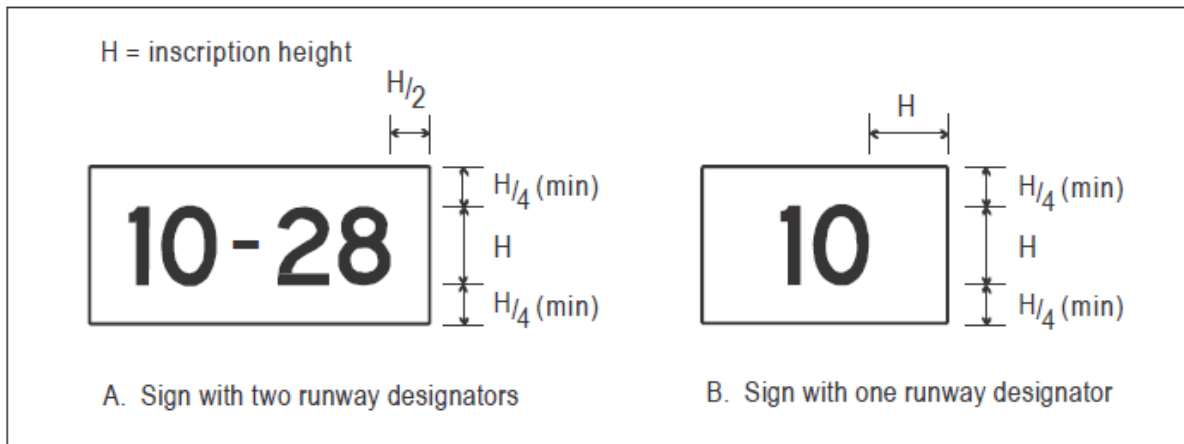

“H” stands for the inscription height

**Figure A5-4. Sign dimensions**

**Table A4-1. Letter and numeral widths and space between letters or numerals**

a) Letter to letter code number			
Preceding Letter	Following Letter		
	B, D, E, F, H, I, K, L, M, N, P, R, U	C, G, O, Q, S, X, Z	A, J, T, V, W, Y
	Code number		
A	2	2	4
B	1	2	2
C	2	2	3
D	1	2	2
E	2	2	3
F	2	2	3
G	1	2	2
H	1	1	2
I	1	1	2
J	1	1	2
K	2	2	3
L	2	2	4
M	1	1	2
N	1	1	2
O	1	2	2
P	1	2	2
Q	1	2	2
R	1	2	2
S	1	2	2
T	2	2	4
U	1	1	2
V	2	2	4
W	2	2	4
X	2	2	3
Y	2	2	4
Z	2	2	3

d) Width of letter			
Letter	Letter height (mm)		
	200	300	400
	Width (mm)		
A	170	255	340
B	137	205	274
C	137	205	274
D	137	205	274
E	124	186	248
F	124	186	248
G	137	205	274
H	137	205	274
I	32	48	64
J	127	190	254
K	140	210	280
L	124	186	248
M	157	236	314
N	137	205	274
O	143	214	286
P	137	205	274
Q	143	214	286
R	137	205	274
S	137	205	274
T	124	186	248
U	137	205	274
V	152	229	304
W	178	267	356
X	137	205	274
Y	171	257	342
Z	137	205	274

b) Numeral to numeral code number			
Preceding Numeral	Following number		
	1, 5	2, 3, 6, 8, 9, 0	4, 7
	Code number		
1	1	1	2
2	1	2	2
3	1	2	2
4	2	2	4
5	1	2	2
6	1	2	2
7	2	2	4
8	1	2	2
9	1	2	2
0	1	2	2

e) Width of numeral			
Numeral	Numeral height (mm)		
	200	300	400
	Width (mm)		
1	50	74	98
2	137	205	274
3	137	205	274
4	149	224	298
5	137	205	274
6	137	205	274
7	137	205	274
8	137	205	274
9	137	205	274
0	143	214	286

c) Space between characters			
Code No.	Character height (mm)		
	200	300	400
	Space (mm)		
1	48	71	96
2	38	57	76
3	25	38	50
4	13	19	26

**INSTRUCTIONS**

1. To determine the proper SPACE between letters or numerals, obtain the code number from table a) or b) and enter table c) for that code number to the desired letter or numeral height.

2. The space between words or groups of characters forming an abbreviation or symbol should be equal to 0.5 to 0.75 of the height of the characters used except that where an arrow is located with a single character such as 'A →', the space may be reduced to not less than one quarter of the height of the character in order to provide a good visual balance.

3. Where the numeral follows a letter or vice versa use Code 1.

4. Where a hyphen, dot, or diagonal stroke follows a character or vice versa use Code 1.

5. For the intersection take-off sign, the height of the lower case "m" is 0.75 of the height of the preceding "0" (zero) and spaced from the preceding "0" at code 1 for the character height of the numerals.

## Appendix 6 Location of lights on obstacles

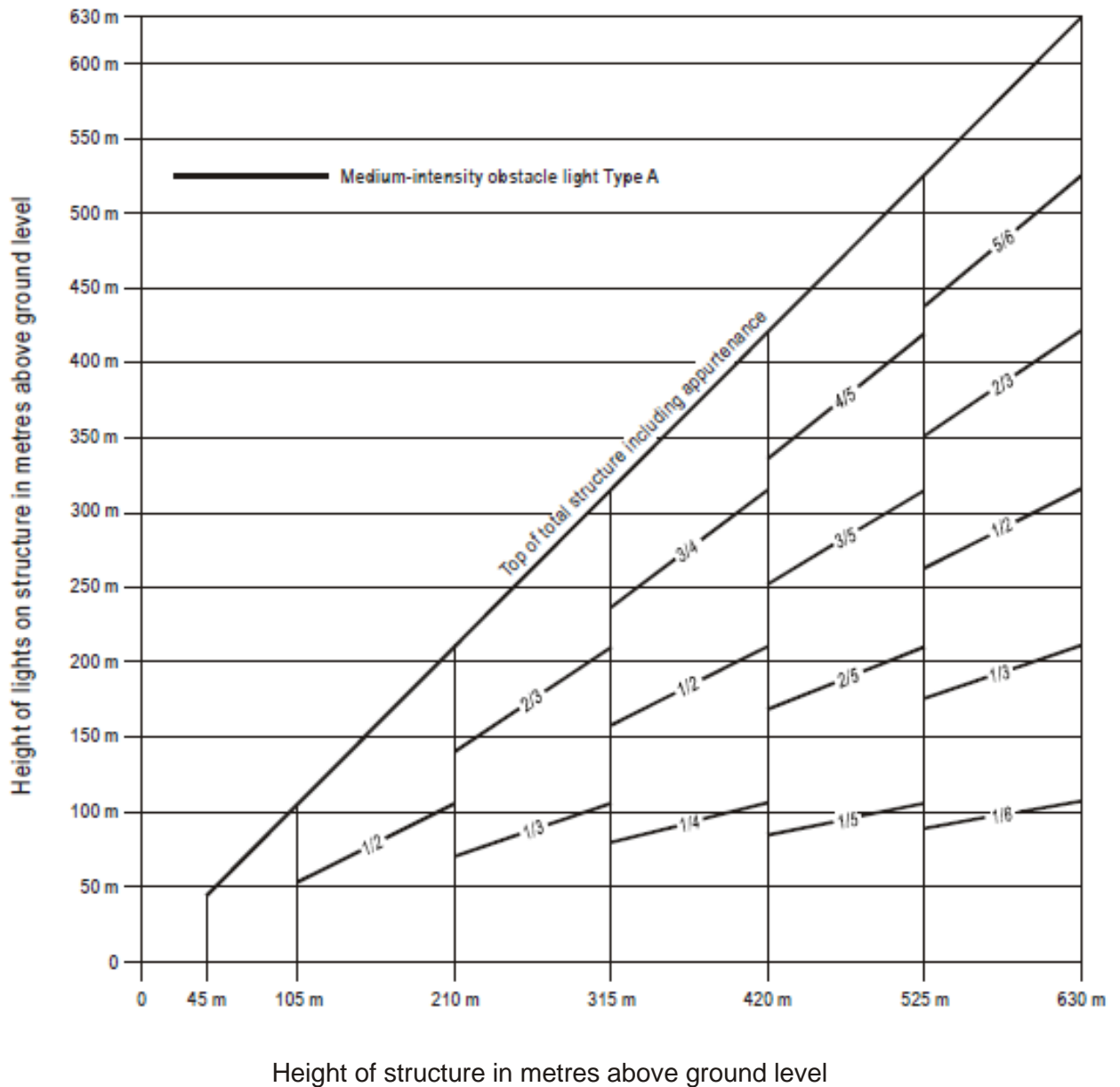

Note.— High-intensity obstacle lighting is recommended on structures with a height of more than 150 m above ground level. If medium-intensity lighting is used, marking will also be required.

**Figure A6-1. Medium-intensity flashing-white obstacle lighting system, Type A**

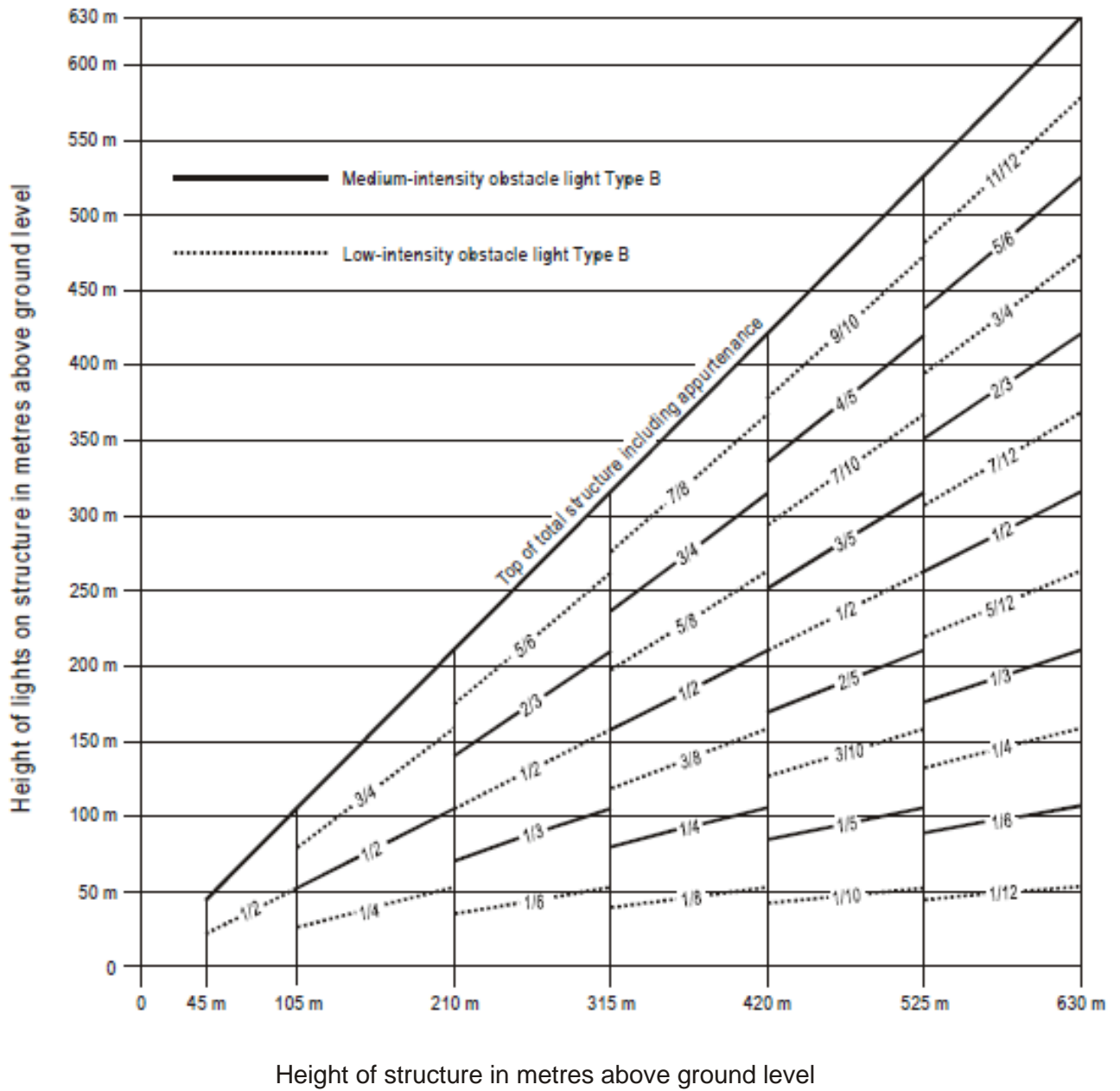

Note.— For night-time use only.

**Figure A6-2. Medium-intensity flashing-red obstacle lighting system, Type B**



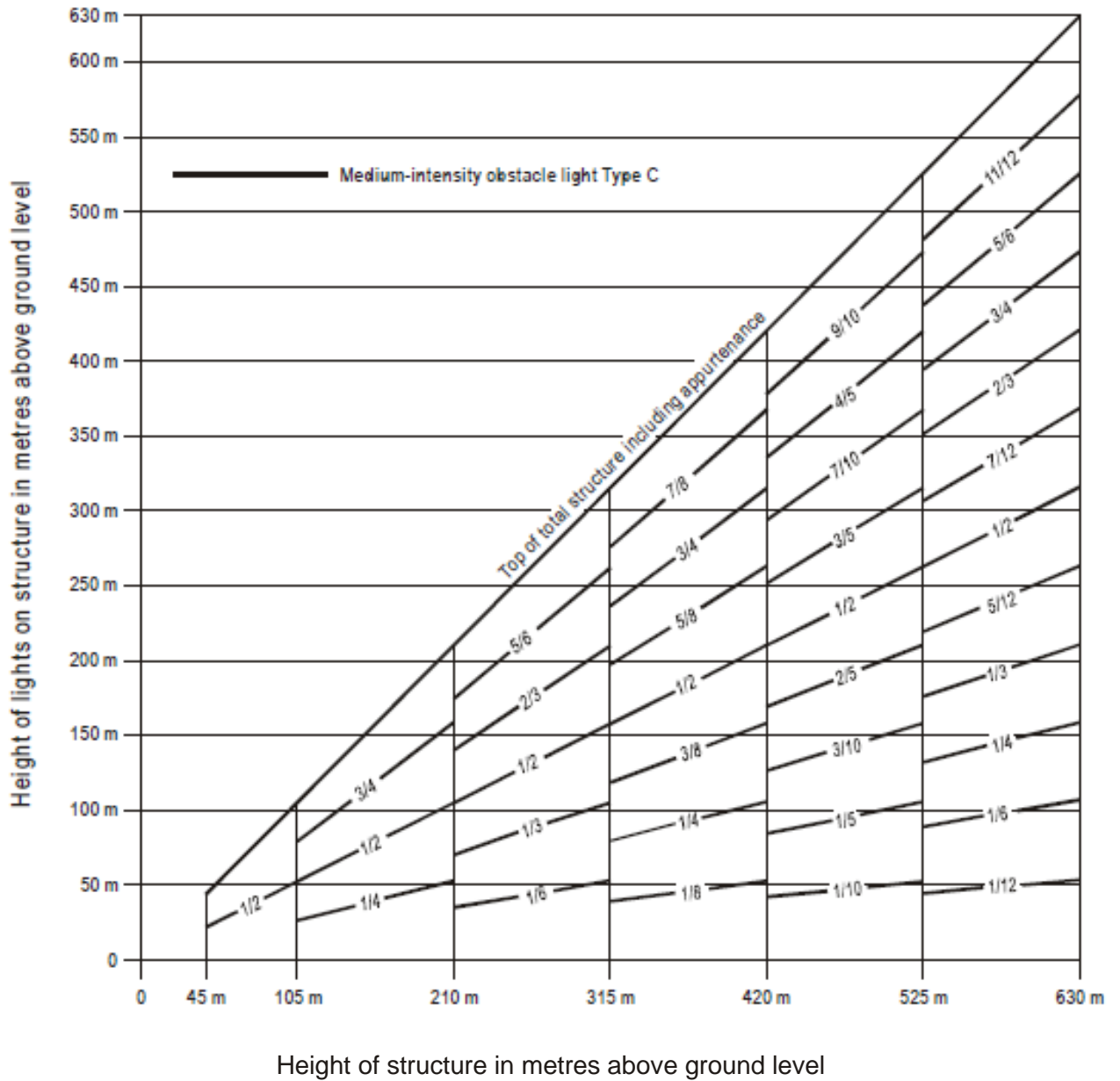

Note.— For night-time use only.

Figure A6-3. Medium-intensity fixed-red obstacle lighting system, Type C

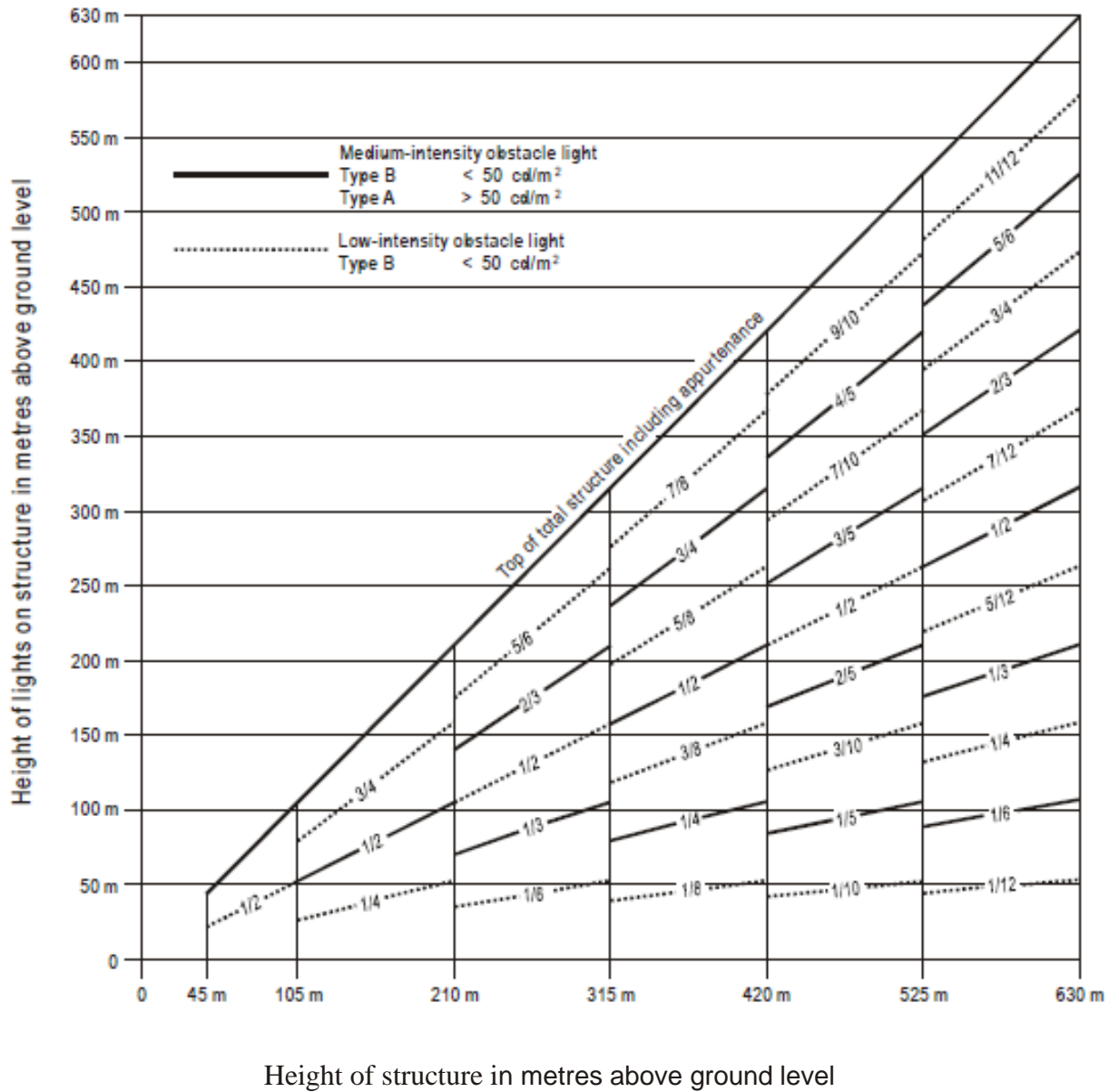

Note.— High-intensity obstacle lighting is recommended on structures with a height of more than 150 m above ground level. If medium-intensity lighting is used, marking will also be required.

**Figure A6-4. Medium-intensity dual obstacle lighting system, Type A/Type B**

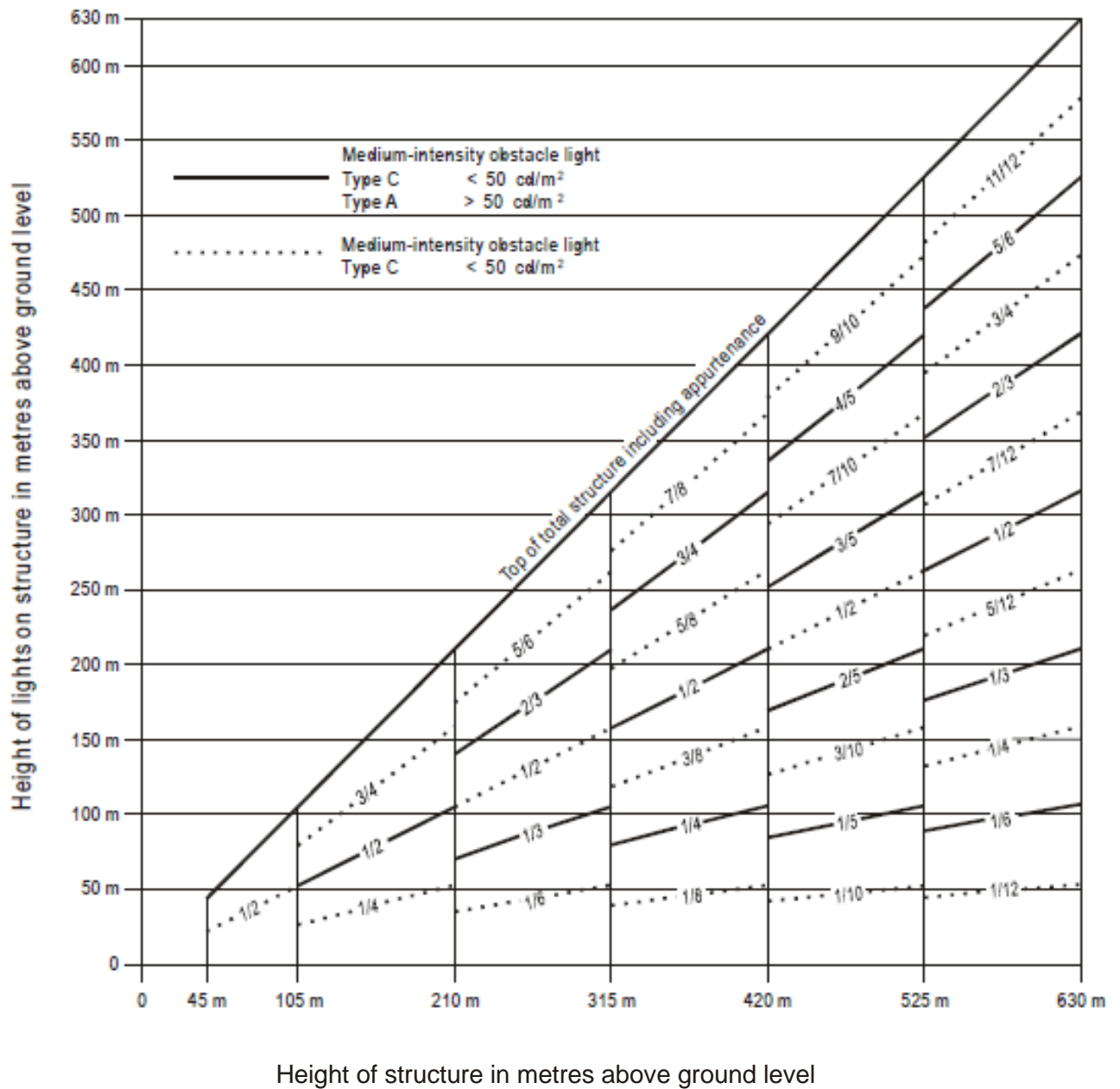

Note.— High-intensity obstacle lighting is recommended on structures with a height of more than 150 m above ground level. If medium-intensity lighting is used, marking will also be required.

**Figure A6-5. Medium-intensity dual obstacle lighting system, Type A/Type C**

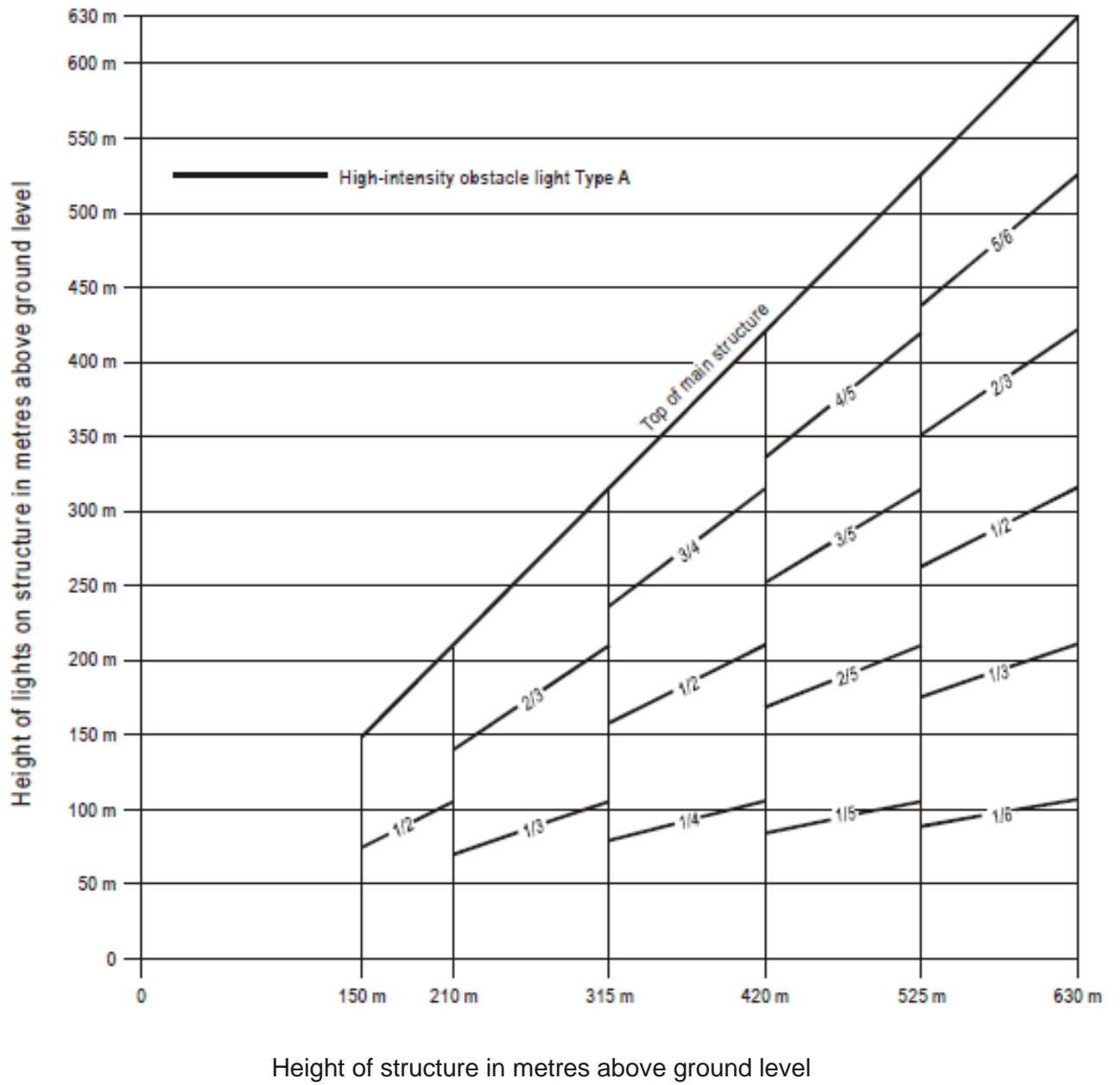

Figure A6-6. High-intensity flashing-white obstacle lighting system, Type A

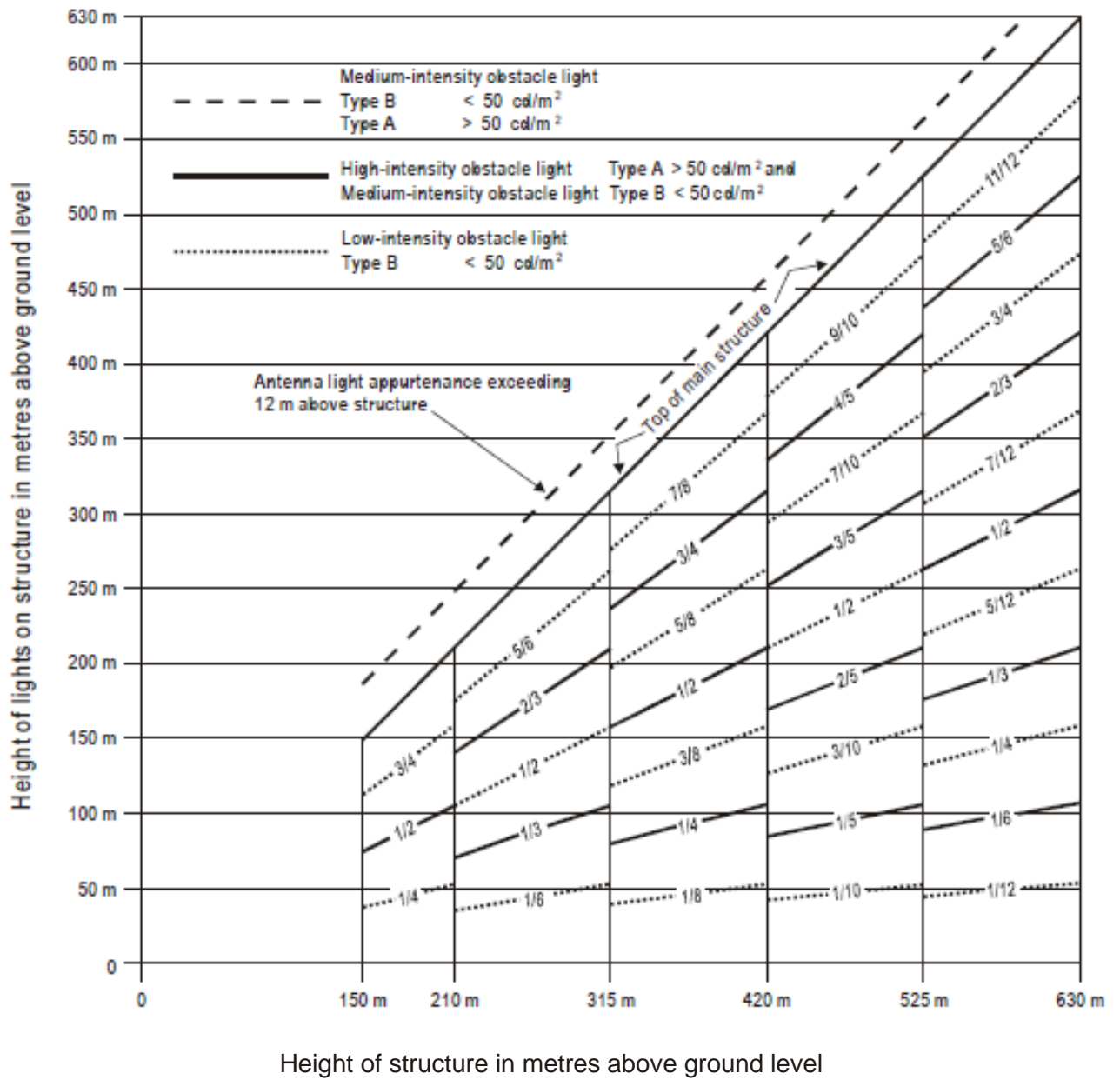

Figure A6-7. High-/medium-intensity dual obstacle lighting system, Type A/Type B

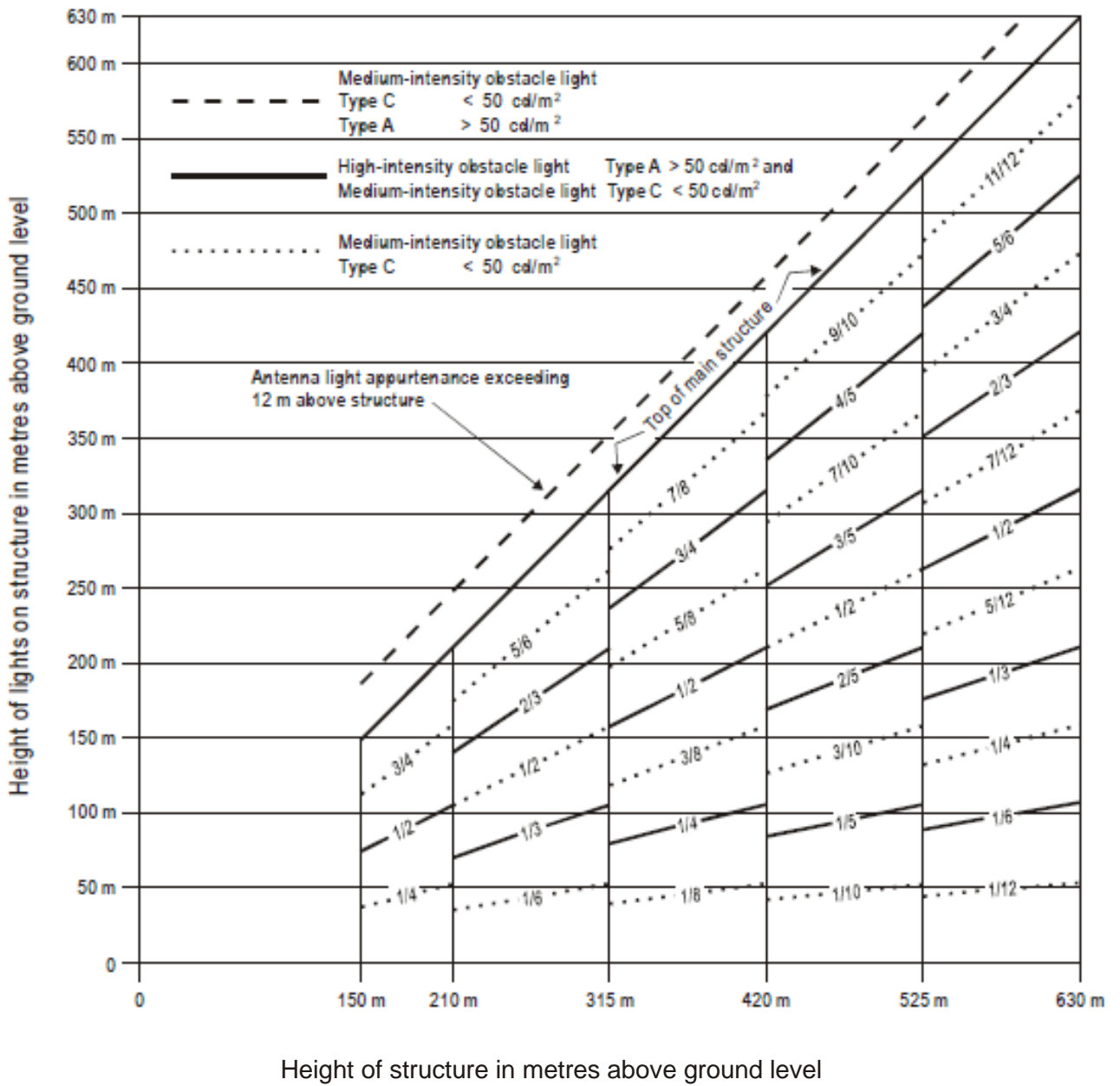

Figure A6-8. High-/medium-intensity dual obstacle lighting system, Type A/Type C