



Manual of Standards - Air Traffic Services

Version 2.8: 1 January 2020

**published by
Civil Aviation Authority of Singapore**

INTENTIONALLY LEFT BLANK

TABLE OF CONTENTS

	<i>Page</i>
FOREWORD	(xx)
INTRODUCTION	(xvii)
CHAPTER 1 Definitions	1-1
1.1 Introduction	1-1
1.2 Air traffic services terms	1-1
CHAPTER 2 ATS organisation requirements	2-1
2.1 Safety management system	2-1
2.2 [Reserved]	2-2
2.3 [Reserved]	2-2
2.4 [Reserved]	2-2
2.5 Safety reviews	2-2
2.6 [Reserved]	2-4
2.7 [Reserved]	2-4
2.8 Human resources management	2-5
2.9 Training and assessment for air traffic controllers	2-6
2.10 Requirements for aeronautical station operators	2-8
CHAPTER 3 ATS system capacity and air traffic flow management	3-1
3.1 Capacity management	3-1
3.2 Air traffic flow management	3-3
CHAPTER 4 General provisions for air traffic services	4-1
4.0 Establishment of authority	4-1
4.1 Responsibility for the provision of air traffic control service	4-1
4.2 Responsibility for the provision of flight information service and alerting service	4-3
4.3 Division of responsibility for control between air traffic control units	4-4
4.4 Flight plan	4-6
4.5 Air traffic control clearances	4-8

4.6	Horizontal speed control instructions	4-11
4.7	Vertical speed control instructions	4-13
4.8	Change from IFR to VFR flight	4-14
4.9	Wake turbulence categories	4-15
4.10	Altimeter setting procedures	4-15
4.11	Position reporting	4-18
4.12	Reporting of operational and meteorological information	4-21
4.13	Presentation and updating of flight plan and control data	4-25
4.14	Failure or irregularity of systems and equipment	4-26
4.15	Data link communications initiation procedures	4-26
4.16	Requirements for communications	4-27
4.17	Time in air traffic services	4-27
4.18	Identification and delineation of prohibited, restricted and danger areas	4-28

CHAPTER 5 Separation methods and minima 5-1

5.1	Introduction	5-1
5.2	Provisions for the separation of controlled traffic	5-1
5.3	Vertical separation	5-3
5.4	Horizontal separation	5-5
5.5	Separation of aircraft holding in flight	5-39
5.6	Minimum separation between departing aircraft	5-40
5.7	Separation of departing aircraft from arriving aircraft	5-40
5.8	Time-based wake turbulence longitudinal separation minima	5-43
5.9	Clearances to fly maintaining own separation while in visual meteorological conditions [Reserved]	5-49
5.10	Essential traffic information	5-49
5.11	Reduction in separation minima	5-50

CHAPTER 6 Separation in the vicinity of aerodromes 6-1

6.1	Reduction in separation minima in the vicinity of aerodromes	6-1
6.2	Essential local traffic	6-1
6.3	Procedures for departing aircraft	6-1
6.4	Information for departing aircraft	6-4
6.5	Procedures for arriving aircraft	6-4
6.6	Information for arriving aircraft	6-11
6.7	Operations on parallel or near-parallel runways	6-13

CHAPTER 7 Procedures for aerodrome control service 7-1

7.1	Functions of aerodrome control towers	7-1
7.2	Selection of runway-in-use	7-3
7.3	Initial call to aerodrome control tower	7-4
7.4	Information to aircraft by aerodrome control towers	7-5

10.6	Coordination between meteorological and air traffic services authorities	10-10
10.7	Coordination between aeronautical information services and air traffic services authorities	10-10
CHAPTER 11 Air traffic services messages		11-1
11.1	Categories of messages	11-1
11.2	General provisions	11-3
11.3	Methods of message exchange	11-6
11.4	Message types and their application	11-9
CHAPTER 12 Phraseologies		12-1
12.1	Communications procedures	12-1
12.2	General	12-1
12.3	ATC phraseologies	12-3
12.4	ATS surveillance service phraseologies	12-32
12.5	Automatic dependent surveillance — contract (ADS-C) phraseologies	12-40
12.6	Alerting phraseologies	12-40
12.7	Ground crew/flight crew phraseologies	12-40
CHAPTER 13 Automatic dependent surveillance — contract (ADS-C) services		13-1
13.1	General	13-1
13.2	ADS-C ground system capabilities	13-1
13.3	ADS-C-related aeronautical information	13-2
13.4	ADS-C procedures	13-2
13.5	Factors to be considered when using ADS-C	13-4
13.6	ADS-C connection management	13-5
13.7	Reporting rates	13-8
13.8	Separation	13-9
13.9	Air traffic clearance monitoring	13-11
13.10	Coordination	13-12
13.11	Alerting service	13-12
13.12	Position reporting	13-12
CHAPTER 14 Controller-pilot data link communications (CPDLC)		14-1
14.1	General	14-1
14.2	Connection management	14-2
14.3	The AFN logon	14-2

APPENDICES

APPENDIX 1	Instructions for air-reporting by voice communications	A1-1
APPENDIX 2	Flight plan	A2-1
APPENDIX 3	Air traffic services messages	A3-1
APPENDIX 4	Air traffic incident report	A4-1
APPENDIX 5A	FANS-1/A CPDLC message set and intent	A5A-1
APPENDIX 5B	FANS-1/A CPDLC standard free text messages	A5B-1
APPENDIX 6	ATS interfacility data communications (AIDC) Messages [Reserved]	A6-1
APPENDIX 7	Application Form for Air Traffic Service Provider Certificate [Reserved]	A7-1
APPENDIX 8	Facility Requirements	A8-1
APPENDIX 9	Documents and Records	A9-1

AMENDMENT RECORDS

The amendments listed below have been incorporated into this copy of the Manual of Standards – Air Traffic Services.

Amendment Number	Version Number	Subject	Source	Sections affected	Entered by (Date)	Approved by (Date)	Effective date
-	1	Original version	ICAO Annex 11 (incorporating Amendment 46) PANS-ATM (incorporating Amendment No.2)	All	Dieu Eng Kwee (1 Oct 2009)	Loo Chee Beng (1 Oct 2009)	1 Oct 2009
1	1.1	List of Effective Pages [Deleted]	ICAO Annex 11 (incorporating Amendment 47)		Dieu Eng Kwee (27 April 2010)	Loo Chee Beng (28 April 2010)	29 April 2010
		Foreword	Arising from AAR Div's continual review of the MOS-ATS	Pg (x)			
		Introduction		Pg (xi to xv)			
		The minimum requirements of an SMS	ICAO Annex 11	2.1.3			
		Human Factors aspects	Assembly – 35th Session Report of the Technical Commission	2.5.2.1			
		Post-implementation monitoring	ICAO Annex 11	2.6.1.2			

Amendment Number	Version Number	Subject	Source	Sections affected	Entered by (Date)	Approved by (Date)	Effective date
		Human resources management	Adapted from HK CAD 670.	2.8			
		Reduced vertical separation minimum (RVSM) approved aircraft	MID/ASIA SUPPS	4.4.1.4			
		Requirements for communications	ICAO Annex 11	4.16			
		Recording and retention of data for investigative purposes	ICAO Annex 11	4.16.2			
		Time in air traffic services	ICAO Annex 11	4.17			
		Clearance to fly maintaining own separation while in visual meteorological conditions	PANS-ATM	5.9			
		Information on the operational status of navigation services	ICAO Annex 11	Para 7.1.3			
		Essential information on aerodrome conditions	ICAO Annex 11	Para 7.1.4 7.5.1 7.5.2 7.5.3 7.5.4 7.5.5			
		Light signals to aircraft	ICAO Annex 2	7.6.3.1.5			
		Coordination between the air / aerodrome operator and air traffic services	ICAO Annex 11	10.5			
		Coordination between meteorological and air traffic services authorities	ICAO Annex 11	10.6			

Amendment Number	Version Number	Subject	Source	Sections affected	Entered by (Date)	Approved by (Date)	Effective date
		Formation flights Air traffic incident report ATS operations manual	ICAO Annex 2 ICAO Annex 13 Eurocontrol Safety Regulatory Requirement (ESARR 2) AAR	16.1.3 16.3.3 16.3.4 16.3.5 16.7			
2	2.0	Foreword Introduction Requirements for communications	Ministerial Direction No. 01/2010 Arising from AAR Div's continual review of the MOS-ATS	Pg (xii) Pg (xiii) to (xvi) 4.16.1	AAR Division (30 July 2010)	Chief Executive (30 July 2010)	30 July 2010
		Safety Management Systems	ICAO Annex 11 (incorporating provisions in Amendment 47 applicable on 18 Nov 2010)	2.1.3	AAR Division (30 July 2010)	Chief Executive (30 July 2010)	18 Nov 2010
3	2.1		PANS-ATM (incorporating Amendment No. 3) CAAS (ANS) (Amendment) Directions 2011 Arising from AAR Div's continual review of the MOS-ATS		AAR Division (17 Nov 2010)	Authority (12 Jan 2011)	12 Jan 2011

Amendment Number	Version Number	Subject	Source	Sections affected	Entered by (Date)	Approved by (Date)	Effective date
		Foreword	Arising from CAAS (ANS) (Amendments) Directions 2011	Pg (xiv)			
		Definitions: Area Navigation (RNAV) Common Point		Pg 1-8 Pg 1-10			
		Reporting of operational and meteorological information		4.12.1 4.12.2, Section 3 (9) 4.12.2.2 4.12.3.1 (a) (b) 4.12.3.2, Data block 2 4.12.6.3			
		Lateral Separation Criteria and Minima		5.4.1.2.1.4 5.4.1.2.1.4.1 (a) (b) Notes 1-4 5.4.1.2.1.5 5.4.1.2.1.6 (a) (b) Notes 1-3 5.4.1.2.1.7 5.4.2.2.1 (b) (c) Figure 5-16A, 5-16B Figure 5-17A, 5-17B			
		Distance-based wake turbulence separation minima		8.7.3.4			
		Position-report and Air-report Messages		11.4.2.6.4.1 (b)			

Amendment Number	Version Number	Subject	Source	Sections affected	Entered by (Date)	Approved by (Date)	Effective date
		Air traffic incident report		16.3.4 (b)			
		Reporting instructions Model AIREP Special		Appendix 1 A1-2 to A1-3 A1-5 to A1-7 A1-9			
4	2.2		Annex 11 (incorporating Amendment 48) PANS-ATM (incorporating Amendment No. 4) Arising from AAR Div's continual review of the MOS-ATS		AAR Division (25 June 2013)	CAAS Authority (21 June 2013)	25 June 2013
		Definitions: Accident Minimum fuel Multilateration (MLAT) system Time difference of arrival (TDOA)		Pg 1-1 Pg 1-20 Pg 1-21 Pg 1-29			
		Requirements and procedures for independent parallel approaches		Pg 6-16			

Amendment Number	Version Number	Subject	Source	Sections affected	Entered by (Date)	Approved by (Date)	Effective date
		ATS Surveillance Systems Capabilities		Pg 8-1 to 8-4			
		Situation Display		Pg 8-4			
		Use of SSR Transponders and ADS-B Transmitters		Pg 8-6 to 8-8			
		General Procedures		Pg 8-11 to 8-19			
		Use of ATS Surveillance Systems in the Air Traffic Control Service		Pg 8-21 to 8-25			
		Emergencies, Hazards and Equipment Failures		Pg 8-27			
		Use of ATS Surveillance Systems in the Aerodrome Control Service		Pg 8-36 to 8-37			
		Coordination		Pg 10-9			

Amendment Number	Version Number	Subject	Source	Sections affected	Entered by (Date)	Approved by (Date)	Effective date
		ATC Phraseologies		Pg 12-7			
		Procedures related to emergencies, communication failure and contingencies		Pg 15-1 to 15-23			
5	2.3	Annex 11 (incorporating Amendment 49) Arising from AAR Div's continual review of the MOS-ATS			AAR Division (25 June 2014)	CAAS Authority (25 June 2014)	4 July 2014
		Foreword		Pg xvi			
		Identification and delineation of prohibited, restricted and danger areas		Pg 4-30			
6	2.4	Amend definition of SIGMET INFORMATION in accordance with Amendment 50 to Annex 11		Pg 1-27	AAR Division (14 October 2016)	CAAS Authority (14 October 2016)	21 October 2016
		Enhance the requirements on safety management		Pg 2-1 to 2-2			

Amendment Number	Version Number	Subject	Source	Sections affected	Entered by (Date)	Approved by (Date)	Effective date
		Formalise the requirements on aeronautical station operators		Pg 2-6 to 2-7			
7	2.5	Table of Contents Introduction Formalise the requirement for the ANSP to establish and maintain a system to train and assess its personnel providing ATC		Pg (iii) Pg (xvii) Pg 2-5 to 2-8	AAR Division (1 February 2017)	Authority (26 January 2017)	1 February 2017
8	2.6	Definitions		Paragraph 1.2. The following new definitions were introduced in line with MOS-PEL and the proposed regulatory framework. <ul style="list-style-type: none"> • Air traffic controller rating • ATC skill-set • Controller working positions • Manual of Standards – Licensing of Air Traffic Control Personnel 	AAR Division (21 June 2018)	Authority (21 June 2018)	29 June 2018

Amendment Number	Version Number	Subject	Source	Sections affected	Entered by (Date)	Approved by (Date)	Effective date
				<p>The following definitions were relevant to the requirements to be added into the MOS-ATS in accordance with ICAO's Amendment 50-A to Annex 11.</p> <ul style="list-style-type: none"> • Performance-based communication (PBC) • Performance-based surveillance (PBS) • Required communication performance (RCP) specification • Required surveillance performance (RSP) specification 			

Amendment Number	Version Number	Subject	Source	Sections affected	Entered by (Date)	Approved by (Date)	Effective date
		Safety Management System		Paragraph 2.1.7. Revised to require the ANSP to 'close the loop' with the ANS Regulator while it is addressing such deficiency.			
		Safety Reviews		Paragraph 2.5.1.1. Revised to provide the assurance that safety reviews will be conducted at least annually.			
		Human Resources Management		Paragraph 2.8.2.3. Revised to clarify that this is a requirement.			
		Capacity Management		Paragraph 3.1.1.1; 3.1.1.2; 3.1.1.3; 3.1.1.4; 3.1.1.5. Revised to incorporate the requirements on the ANSP to determine the declared capacity for each of its ATC unit and to document the methodologies for determining these declared capacities.			

Amendment Number	Version Number	Subject	Source	Sections affected	Entered by (Date)	Approved by (Date)	Effective date
		Provisions for the separation of controlled traffic		Paragraph 5.2.2.1; 5.2.3.1; 5.2.4.1. Revised to include new requirements in accordance with ICAO's Amendment 50-A to Annex 11.			
		Control of departing aircraft		Paragraph 7.9.2.1; 7.9.3.1; 7.9.3.3; 7.9.3.3A; 7.9.3.4. Revised to enhance the clarity of the requirements on the ANSP regarding take-off clearance and correction to the paragraph references.			

Amendment Number	Version Number	Subject	Source	Sections affected	Entered by (Date)	Approved by (Date)	Effective date
9	2.7	Use of visual surveillance system in the provision of aerodrome control service	PANS-ATM (incorporating Amendment No. 8 to the 16th Edition)	<p>Added the definition for Visual Surveillance System in accordance with ICAO's Amendment No.8 to the 16th Edition of the PANS-ATM.</p> <p>Paragraph 7.1.1.2: Amended to incorporate PANS ATM Amendment No. 8 to the 16th Edition.</p> <p>Added Para 7.1.3A: Requirements on use of visual surveillance system for the provision of aerodrome control services.</p>	AAR Division (29 August 2019)	Authority (29 August 2019)	12 September 2019
		Ramp control service		<p>Added the definition for Ramp Control Service.</p> <p>Paragraph 7.6.4: Added the requirements for the ANSP to establish training and competency programme for its RCS personnel.</p>			

Amendment Number	Version Number	Subject	Source	Sections affected	Entered by (Date)	Approved by (Date)	Effective date
		Reporting of safety occurrences		Paragraph 16.3: Amended to enhance the clarity on the ANSP's reporting of safety occurrences to the ANS Regulator.			
		Investigation of safety occurrences		Paragraph 16.3A: Amended to enhance the requirements on the ANSP on the investigation of safety occurrences.			
10	2.8	Amendment to the “air traffic controller rating” and “dependent parallel approaches” definitions		Paragraph 1.2	SPP Division/ RD (10 December 2019)	Authority (28 November 2019)	1 January 2020
		Amendment to the requirements for air traffic controller recency		Paragraphs 2.9.4.1, 2.9.4.2, 2.9.4.3: Amended to require the ANSP to establish a recency programme.			
		Amendment to the requirements for dependent parallel approaches		Paragraphs 6.7.3.4.3 and 6.7.3.4.4: Amended the minimum horizontal separation to be provided diagonally between successive aircraft on adjacent final approach courses or tracks			

FOREWORD

Pursuant to paragraph 5 of the Ministerial Direction No. 01/2010 [as amended by the CAAS (ANS) (Amendment) Directions 2011], this Manual of Standards – Air Traffic Services is issued by CAAS specifying the national standards and requirements to be met by the air navigation service provider within the Singapore Flight Information Region.

The Manual of Standards – Air Traffic Services (MOS-ATS) contains the standards, requirements and procedures pertaining to the provision of air navigation services. The standards and requirements in this Manual are based mainly on standards and recommended practices stipulated in Annex 11 (entitled “Air Traffic Services”) to the Chicago Convention on International Civil Aviation (as in force and amended from time to time by the Council of the International Civil Aviation Organisation) and in the Procedures for Air Navigation Services – Air Traffic Management, and with such modifications as may be determined by CAAS to be applicable in Singapore.

Readers should forward advice of errors, inconsistencies or suggestions for improvement to this Manual to the addressee stipulated below.

**Director (Aerodrome and Air Navigation Services Regulation)
Civil Aviation Authority of Singapore
PO Box 1, Singapore Changi Airport
Singapore 918141**

INTRODUCTION

1 Manual of Standards – Air Traffic Services (MOS - ATS)

- 1.1 The MOS - ATS prescribes the detailed technical provisions that contains standards, procedures, instructions and information which are intended to form the basis of air traffic services within the Singapore Flight Information Region. The air navigation services provider (ANSP) in Singapore is required to comply with the provisions contained in the manual. The ANSP shall document local procedures in their own operational manuals, to ensure the maintenance of and compliance with standards.
- 1.2 The provisions in this Manual are based on the Procedures for Air Navigation Services – Air Traffic Management (PANS-ATM) and ICAO Annex 11.
- 1.3 In addition to the Manual of Standards, the following may also be issued as and when required to supplement the Manual of Standards:
- (a) Safety Directive – this is a mandatory requirement to be complied by the ANSP. It is published for purposes of immediate promulgation of local standards and recommended practices in response to, but not limited to, amendments to ICAO Annexes. The Safety Directives will be incorporated into subsequent amendments of the Manual of Standards.
 - (b) Safety Publication – this is published for purposes of promulgating supplementary guidance materials to the standards and recommended practices in the Manual of Standards. The publications are intended to provide recommendations and guidance to illustrate a means, but not necessarily the only means, of complying with the Manual of Standards. Safety Publications may explain certain regulatory requirements by providing interpretive and explanatory materials.
 - (c) Information Circular – this is published for purposes of bringing to the attention of the ANSP educational materials related to aviation safety. The publications could be initiated as a result of ICAO State letters which do not require immediate changes to local regulations, new safety initiatives or international best practices as identified by AAR Division. The ANSP is encouraged to review and adopt the material if practicable. Where appropriate, the material in the publications may be incorporated into subsequent amendments of the Manual of Standards.
- 1.4. Where the ANSP is unable to comply with any provision in any of the Manuals of Standards, the ANSP shall inform the ANS Regulator within a reasonable period of time and in writing. The ANSP shall explain the basis for its non-compliance

and propose alternative steps to ensure that an equivalent level of safety is established. The ANS Regulator will review the ANSP's proposal in a timely fashion and approve the proposal, subject to such other conditions it may impose. The ANSP is required to follow-up diligently and thereafter report to the ANS Regulator within a reasonable period.

- 1.5 Where the ANS Regulator has approved the ANSP's proposal under paragraph 1.4, the ANSP shall record the approved alternative steps to be taken in the ANSP's operations manuals. These manuals shall also contain the details of and rationale for the alternative steps, and any resultant limitations or conditions imposed.
- 1.6 The ANSP shall ensure that the units of measurement as specified in the Manual of Standards – Units of Measurement to be used in Air and Ground Operations are used for the provision of air traffic services.

2 Differences between ICAO Standards and those in MOS - ATS

Where there is a difference between a standard prescribed in ICAO documents and the MOS - ATS, the MOS - ATS standard shall prevail.

3 Editorial Practices

To avoid any misunderstanding within the MOS - ATS, the words 'shall' as used within the requirements indicate that compliance is compulsory, while 'should' means that it is strongly advisable that an instruction is carried out; it is recommended or discretionary.

5 Differences Published in AIP

A list of significant differences from the MOS - ATS shall be included and published in AIP Singapore.

6 Related Documents

This Manual should be read in conjunction with:

- (a) ICAO Annex 2 – Rules of the Air
- (b) ICAO Annex 10 – Aeronautical Telecommunications, Volume II – Communications Procedures;
- (c) ICAO Annex 11 – Air Traffic Services;
- (d) ICAO Annex 15 – Aeronautical Information Services;

- (e) ICAO Air Traffic Services Planning Manual (Doc 9426);
- (f) ICAO Regional Supplementary Procedures (Doc 7030);
- (g) Singapore Aeronautical Information Publication (AIP);

7 Contents of the Document

Chapter 1 contains definitions.

Chapter 2 contains provisions and procedures regarding safety management of the air traffic services.

Chapter 3 contains provisions and procedures applicable to air traffic flow management.

Chapter 4 contains general provisions and procedures applicable to the air traffic services.

Chapter 5 contains provisions and procedures applicable to the separation of aircraft.

Chapter 6 contains provisions and procedures applicable to departing and arriving aircraft.

Chapter 7 contains provisions and procedures applicable by air traffic control units providing aerodrome control service.

Chapter 8 contains procedures applicable by air traffic services units using radar in the performance of their functions.

Chapter 9 contains procedures applicable by air traffic services units providing flight information service and alerting service.

Chapter 10 contains procedures regarding the coordination to be effected between air traffic services units, between control positions within such units, and between such units and associated aeronautical telecommunication stations.

Chapter 11 contains procedures relating to the air traffic services messages which are necessary for the effective operation of air traffic services.

Chapter 12 contains typical phraseologies to be used in the provision of air traffic services, arranged in groups to relate to the particular phase of air traffic services with which they are generally employed.

Chapter 13 contains procedures regarding automatic dependent surveillance — contract (ADS-C) services.

Chapter 14 contains procedures concerning controller-pilot data link communications (CPDLC). The associated CPDLC message set is contained in Appendix 5A and 5B.

Chapter 15 contains procedures related to emergencies, communication failure and contingencies.

Chapter 16 contains procedures applicable to special air operations, incident reporting, repetitive flight plans, strategic lateral offsets procedures, and communicable diseases on board an aircraft.

INTENTIONALLY LEFT BLANK

CHAPTER 1

DEFINITIONS

1.1 INTRODUCTION

1.1.1 The terms used in this document, and defined below, are those used to describe facilities, services and procedures for air traffic and related services. As far as possible, the terms used in this document, and defined below, are those which have the widest international use.

1.2 AIR TRAFFIC SERVICES TERMS

1.2.1 When the following terms are used in this Manual, they have the following meanings:

A

ACCEPTING UNIT

An air traffic control unit next to take control of an aircraft.

ACCIDENT

An occurrence associated with the operation of an aircraft which, in the case of a manned aircraft, takes place between the time any person boards the aircraft with the intention of flight until such time as all such persons have disembarked, or in the case of an unmanned aircraft, takes place between the time the aircraft is ready to move with the purpose of flight until such time it comes to rest at the end of the flight and the primary propulsion system is shut down, in which:

- a) a person is fatally or seriously injured as a result of:
- being in the aircraft, or
 - direct contact with any part of the aircraft, including parts which have become detached from the aircraft, or
 - direct exposure to jet blast,

except when the injuries are from natural causes, self-inflicted or inflicted by other persons, or when the injuries are to stowaways hiding outside the areas normally available to the passengers and crew; or

- b) the aircraft sustains damage or structural failure which:
- adversely affects the structural strength, performance or flight characteristics of the

- aircraft, and
- would normally require major repair or replacement of the affected component,

except for engine failure or damage, when the damage is limited to a single engine, (including its cowlings or accessories), to propellers, wing tips, antennas, probes, vanes, tires, brakes, wheels, fairings, panels, landing gear doors, windscreens, the aircraft skin (such as small dents or puncture holes) or for minor damages to main rotor blades, tail rotor blades, landing gear, and those resulting from hail or bird strike (including holes in the radome); or

c) the aircraft is missing or is completely inaccessible.

Note 1.— For statistical uniformity only, an injury resulting in death within thirty days of the date of the accident is classified, by ICAO, as a fatal injury.

Note 2.— An aircraft is considered to be missing when the official search has been terminated and the wreckage has not been located.

Note 3. — The type of unmanned aircraft system to be investigated is addressed in Annex 13, 5.1.

Note 4. — Guidance for the determination of aircraft damage can be found in Annex 13, Attachment G.

ACCURACY

A degree of conformance between the estimated or measured value and the true value.

Note.— For measured positional data the accuracy is normally expressed in terms of a distance from a stated position within which there is a defined confidence of the true position falling.

ADS-C AGREEMENT

A reporting plan which establishes the conditions of ADS-C data reporting (i.e. data required by the air traffic services unit and frequency of ADS-C reports which have to be agreed to prior to using ADS-C in the provision of air traffic services).

Note.— The terms of the agreement will be exchanged between the ground system and the aircraft by means of a contract, or a series of contracts.

AERODROME

A defined area on land or water (including any buildings, installations and equipment) intended to be used either wholly or in part for the arrival departure and surface movement of aircraft.

Note.— The term “aerodrome” where used in the provisions relating to flight plans and ATS messages is intended to cover also sites other than aerodromes which may be used by

certain types of aircraft, e.g. helicopters or balloons.

AERODROME CONTROL SERVICE

Air traffic control service for aerodrome traffic.

AERODROME CONTROL TOWER

A unit established to provide air traffic control service to aerodrome traffic.

AERODROME ELEVATION

The elevation of the highest point of the landing area.

AERODROME TRAFFIC

All traffic on the manoeuvring area of an aerodrome and all aircraft flying in the vicinity of an aerodrome.

Note.— An aircraft is in the vicinity of an aerodrome when it is in, entering or leaving an aerodrome traffic circuit.

AERODROME TRAFFIC CIRCUIT

The specified path to be flown by aircraft operating in the vicinity of an aerodrome.

AERONAUTICAL FIXED SERVICE (AFS)

A telecommunication service between specified fixed points provided primarily for the safety of air navigation and for the regular, efficient and economical operation of air services.

AERONAUTICAL FIXED STATION

A station in the aeronautical fixed service.

AERONAUTICAL GROUND LIGHT

Any light specially provided as an aid to air navigation, other than a light displayed on an aircraft.

AERONAUTICAL INFORMATION PUBLICATION (AIP)

A publication issued by or with the authority of a State and containing aeronautical information of a lasting character essential to air navigation.

AERONAUTICAL MOBILE SERVICE

A mobile service between aeronautical stations and aircraft stations, or between aircraft stations, in which survival craft stations may participate; emergency position-indicating radio beacon stations may also participate in this service on designated distress and emergency frequencies.

AERONAUTICAL STATION

A land station in the aeronautical mobile service. In certain instances, an aeronautical station may be located, for example, on boardship or on a platform at sea.

AERONAUTICAL TELECOMMUNICATION STATION

A station in the aeronautical telecommunication service.

AIRBORNE COLLISION AVOIDANCE SYSTEM (ACAS)	An aircraft system based on secondary surveillance radar (SSR) transponder signals which operates independently of ground-based equipment to provide advice to the pilot on potential conflicting aircraft that are equipped with SSR transponders.
AIRCRAFT	Any machine that can derive support in the atmosphere from the reactions of the air other than the reactions of the air against the earth's surface.
AIRCRAFT ADDRESS	A unique combination of 24 bits available for assignment to an aircraft for the purpose of air-ground communications, navigation and surveillance.
AIRCRAFT IDENTIFICATION	A group of letters, figures or a combination thereof which is either identical to, or the coded equivalent of, the aircraft callsign to be used in air-ground communications, and which is used to identify the aircraft in ground - ground air traffic services communications.
AIRCRAFT OBSERVATION	The evaluation of one or more meteorological elements made from an aircraft in flight.
AIRCRAFT PROXIMITY	<p>A situation in which, in the opinion of a pilot or air traffic services personnel, the distance between aircraft as well as their relative positions and speed have been such that the safety of the aircraft involved may have been compromised. An aircraft proximity is classified as follows:</p> <p><i>Risk of collision:</i> The risk classification of an aircraft proximity in which serious risk of collision has existed.</p> <p><i>Safety not assured:</i> The risk classification of an aircraft proximity in which the safety of the aircraft may have been compromised.</p> <p><i>No risk of collision:</i> The risk classification of an aircraft proximity in which no risk of collision has existed.</p> <p><i>Risk not determined:</i> The risk classification of an aircraft proximity in which insufficient information was available to determine the risk involved, or inconclusive or conflicting evidence precluded such determination.</p>
AIR-GROUND COMMUNICATION	Two way communication between aircraft and stations or locations on the surface of the earth.
AIRPROX	The code word used in an air traffic incident report to designate aircraft proximity.

AIR-REPORT	A report from an aircraft in flight prepared in conformity with requirements for position, and operational and/or meteorological reporting.
AIR-TAXIING	<p>Movement of a helicopter/VTOL above the surface of an aerodrome, normally in ground effect and at a ground speed normally less than 37 km/h (20 kt).</p> <p><i>Note.— The actual height may vary, and some helicopters may require air-taxiing above 8 m (25 ft) AGL to reduce ground effect turbulence or provide clearance for cargo slingloads.</i></p>
AIR TRAFFIC	All traffic in flight, or operating on the manoeuvring area of an aerodrome.
AIR TRAFFIC CONTROL CLEARANCE	<p>Authorisation for an aircraft to proceed under conditions specified by an air traffic unit.</p> <p><i>Note 1. – For convenience, the term “air traffic control clearance” is frequently abbreviated to “clearance” when used in appropriate contexts.</i></p> <p><i>Note 2.— The abbreviated term “clearance” may be prefixed by the words “taxi”, “take-off”, “departure”, “en-route”, “approach” or “landing” to indicate the particular portion of flight to which the air traffic control clearance relates.</i></p>
AIR TRAFFIC CONTROL INSTRUCTION	Directives issued by air traffic control for the purpose of requiring the pilot to take specific action.
AIR TRAFFIC CONTROL SERVICE	<p>A service provided for the purpose of:</p> <ol style="list-style-type: none">a) preventing collisions:<ol style="list-style-type: none">1. between aircraft, and2. on the manoeuvring area between aircraft and obstructions; andb) expediting and maintaining an orderly flow of air traffic.
AIR TRAFFIC CONTROL UNIT	A generic term meaning variously, area control centre, approach control unit or aerodrome control tower.
AIR TRAFFIC CONTROL (ATC) SKILL-SET	A category of skills specific to an air traffic controller rating that are required in order to exercise the privileges associated with that rating.

AIR TRAFFIC CONTROLLER RATING	An authorisation entered on or associated with an air traffic controller licence and forming part thereof, stating special conditions, privileges or limitations pertaining to such licence granted or issued under paragraph 62A(2) of the Air Navigation Order (Cap. 6, O 2).
AIR TRAFFIC FLOW MANAGEMENT (ATFM)	A service established with the objective of contributing to a safe, orderly and expeditious flow of air traffic by ensuring that ATC capacity is utilized to the maximum extent possible, and that the traffic volume is compatible with the capacities declared by the appropriate ATS authority.
AIR TRAFFIC MANAGEMENT	The aggregation of the airborne functions and ground-based functions (air traffic services, airspace management and air traffic flow management) required to ensure the safe and efficient movement of aircraft during all phases of operations.
AIR TRAFFIC MANAGEMENT SYSTEM	A system that provides ATM through the collaborative integration of humans, information, technology, facilities and services, supported by air and ground-and/or space-based communications, navigation and surveillance.
AIR TRAFFIC SERVICE (ATS)	A generic term meaning variously, flight information service, alerting service, air traffic advisory service, air traffic control service (area control service, approach control service or aerodrome control service).
AIR TRAFFIC SERVICES (ATS) AIRSPACE	Airspaces of defined dimensions, alphabetically designated, within which specific types of flights may operate and for which air traffic services and rules of operation are specified. <i>Note: —ATS airspaces are classified as Class A to G as shown in Annex 11, Appendix 4.</i>
AIR TRAFFIC SERVICES REPORTING OFFICE	A unit established for the purpose of receiving reports concerning air traffic services and flight plans submitted before departure. <i>Note.— An air traffic services reporting office may be established as a separate unit or combined with an existing unit, such as another air traffic services unit, or a unit of the aeronautical information service.</i>
AIR TRAFFIC SERVICES UNIT	A generic term meaning variously, air traffic control unit, flight information centre or air traffic services reporting office.

AIRWAY	A control area or portion thereof established in the form of a corridor.
ALERFA	The code word used to designate the alert phase.
ALERTING SERVICE	A service provided to notify appropriate organisations regarding aircraft in need of search and rescue aid, and assist such organisations as required.
ALERT PHASE	A situation wherein apprehension exists as to the safety of an aircraft and its occupants.
ALLOCATION, ALLOCATE	Distribution of frequencies, SSR Codes, etc. to a State, unit or service. Distribution of 24-bit aircraft addresses to a State or common mark registering authority.
ALPHANUMERIC CHARACTERS	A collective term for letters and figures (digits).
ALTERNATE AERODROME	<p>An aerodrome to which an aircraft may proceed when it becomes either impossible or inadvisable to proceed to or to land at the aerodrome of intended landing.</p> <p>Alternate aerodrome includes the following:</p> <p><i>Take-off alternate.</i> An alternate aerodrome at which an aircraft can land should this become necessary shortly after take-off and it is not possible to use the aerodrome of departure.</p> <p><i>En-route alternate.</i> An aerodrome at which an aircraft would be able to land after experiencing an abnormal or emergency condition while en-route.</p> <p><i>ETOPS en-route alternate.</i> A suitable and appropriate alternate aerodrome at which an aeroplane would be able to land after experiencing an engine shut-down or other abnormal or emergency condition while en-route in an ETOPS operation.</p> <p><i>Destination alternate.</i> An alternate aerodrome to which an aircraft may proceed should it become either impossible or inadvisable to land at the aerodrome of intended landing.</p> <p><i>Note.</i> – <i>The aerodrome from which a flight departs may also be an en-route or a destination alternate aerodrome for that flight.</i></p>
ALTITUDE	The vertical distance of a level, a point or an object considered as a point, measured from mean sea level.

APPROACH CONTROL SERVICE	Air traffic control service for arriving or departing controlled flights.
APPROACH CONTROL UNIT	A unit established to provide air traffic control service to controlled flights arriving at, or departing from, one or more aerodromes.
APPROACH SEQUENCE	The order in which two or more aircraft are cleared for an approach to land at the aerodrome.
APPROPRIATE AUTHORITY	a) Regarding flight over the high seas: The relevant authority of the State of Registry. b) Regarding flight other than over the high seas: The relevant authority of the State having sovereignty over the territory being overflown.
APRON	A defined area, on a land aerodrome, intended to accommodate aircraft for purposes of loading or unloading passengers, mail or cargo, fuelling, parking or maintenance.
APRON MANAGEMENT SERVICE	A service provided to regulate the activities and movement of aircraft and vehicles on an apron.
AREA CONTROL CENTRE	A unit established to provide air traffic control service to controlled flights in control areas under its jurisdiction.
AREA CONTROL SERVICE	Air traffic control service for controlled flights in control areas.
AREA NAVIGATION (RNAV)	A method of navigation which permits aircraft operation on any desired flight path within the coverage of ground- or space-based navigation aids or within the limits of the capability of self-contained aids, or a combination of these.
AREA NAVIGATION ROUTE	An ATS route established for the use of aircraft capable of employing area navigation.
ASSIGNMENT, ASSIGN	Distribution of frequencies to stations. Distribution of SSR Codes or 24-bit aircraft addresses to aircraft.
ATIS	The symbol used to designate automatic terminal information service.

ATS ROUTE	<p>A specified route designed for channelling the flow of traffic as necessary for the provision of air traffic services.</p> <p><i>Note 1. — The term "ATS route" is used to mean variously, airway, advisory route, controlled or uncontrolled route, arrival or departure route, etc.</i></p> <p><i>Note 2. — An ATS route is defined by route specifications which include an ATS route designator, the track to or from significant points (waypoints), distance between significant points, reporting requirements and, as determined by the ANSP, the lowest safe altitude.</i></p>
ATS SURVEILLANCE SERVICE	<p>A term used to indicate a service provided directly by means of an ATS surveillance system.</p>
ATS SURVEILLANCE SYSTEM	<p>A generic term meaning variously, ADS-B, PSR, SSR or any comparable ground-based system that enables the identification of aircraft.</p> <p><i>Note.— A comparable ground-based system is one that has been demonstrated, by comparative assessment or other methodology, to have a level of safety and performance equal to or better than monopulse SSR.</i></p>
AUTOMATIC DEPENDENT SURVEILLANCE – BROADCAST (ADS-B)	<p>A means by which aircraft, aerodrome vehicles and other objects can automatically transmit and/or receive data such as identification, position and additional data, as appropriate, in a broadcast mode via a data link.</p>
AUTOMATIC DEPENDENT SURVEILLANCE – CONTRACT (ADS-C)	<p>A means by which the terms of an ADS-C agreement will be exchanged between the ground system and the aircraft, via a data link, specifying under what conditions ADS-C reports would be initiated, and what data would be contained in the reports.</p> <p><i>Note.— The abbreviated term "ADS contract" is commonly used to refer to ADS event contract, ADS demand contract, ADS periodic contract or an emergency mode.</i></p>
AUTOMATIC TERMINAL INFORMATION SERVICE (ATIS)	<p>The automatic provision of current, routine information to arriving and departing aircraft throughout 24 hours or a specified portion thereof:</p> <p><i>Data link-automatic terminal information service (D-ATIS).</i> The provision of ATIS via data link.</p> <p><i>Voice-automatic terminal information service (Voice-ATIS).</i></p> <p>The provision of ATIS by means of continuous and repetitive voice broadcasts.</p>

B**BASE TURN**

A turn executed by the aircraft during the initial approach between the end of the outbound track and the beginning of the intermediate or final approach track. The tracks are not reciprocal.

Note. – Base turns may be designated as being made either in level flight or while descending, according to the circumstances of each individual procedure.

BLIND TRANSMISSION

A transmission from one station to another station in circumstances where two-way communication cannot be established but where it is believed that the called station is able to receive the transmission.

BROADCAST

A transmission of information relating to air navigation that is not addressed to a specific station or stations.

C**CEILING**

The height above the ground or water of the base of the lowest layer of cloud below 6000 metres (20 000 feet) covering more than half the sky.

CHANGE-OVER POINT

The point at which an aircraft navigating on an ATS route segment defined by reference to very high frequency omnidirectional radio ranges is expected to transfer its primary navigational reference from the facility behind the aircraft to the next facility ahead of the aircraft.

Note: — Change-over points are established to provide the optimum balance in respect of signal strength and quality between facilities at all levels to be used and to ensure a common source of azimuth guidance for all aircraft operating along the same portion of a route segment.

CIRCLING APPROACH

An extension of an instrument approach procedure which provides for visual circling of the aerodrome prior to landing.

CLEARANCE LIMIT

The point to which an aircraft is granted an air traffic control clearance.

CODE (SSR)

The number assigned to a particular multiple pulse reply signal transmitted by a transponder in mode A or mode C.

COMMON POINT	A point on the surface of the earth common to the tracks of two aircraft, used as a basis for the application of separation (e.g. significant point, waypoint, navigation aid, fix).
COMPUTER	A device which performs sequences of arithmetical and logical steps upon data without human intervention. <i>Note. – When the word “computer” is used in this document it may denote a computer complex, which includes one or more computers and peripheral equipment.</i>
CONFERENCE COMMUNICATIONS	Communication facilities whereby direct speech conversation may be conducted between three or more locations simultaneously.
CONTROL AREA	A controlled airspace extending upwards from a specified limit above the earth.
CONTROL ASSISTANT	A person who assists in the provision of air traffic services but who is not authorized to make decisions regarding clearances, advice or information to be issued to aircraft.
CONTROLLED AERODROME	An aerodrome at which air traffic control service is provided to aerodrome traffic. <i>Note. – The term “controlled aerodrome” includes that air traffic control service is provided to aerodrome traffic but does not necessarily imply that a control zone exists.</i>
CONTROLLED AIRSPACE	An airspace of defined dimensions within which air traffic control service is provided to IFR flights and to VFR flights in accordance with the airspace classification. <i>Note: — Controlled airspace is a generic term which covers ATS airspace CLASSES A, B, C, D and E as described in Annex 11, 2.6.</i>
CONTROLLED FLIGHT	Any flight which is subject to an air traffic control clearance.
CONTROLLER-PILOT DATA LINK COMMUNICATIONS (CPDLC)	A means of communication between controller and pilot, using data link for ATC communications.
CONTROLLER WORKING POSITIONS	A defined area of location or discrete function, within an air traffic services unit, at or for which an air traffic service is provided by the air traffic controller.

CONTROL ZONE	A controlled airspace extending upwards from the surface of the earth to a specified upper limit.
CRUISING LEVEL	A level maintained during a significant portion of a flight.
CURRENT DATA AUTHORITY	The designated ground system through which a CPDLC dialogue between a pilot and a controller currently responsible for the flight is permitted to take place.
CURRENT FLIGHT PLAN (CPL)	The flight plan, including changes, if any, brought about by subsequent clearances. <i>Note. – When the word “message” is used as a suffix to this term, it denotes the content and format of the current flight plan data sent from one unit to another.</i>
D	
DANGER AREA	An airspace of defined dimensions within which activities dangerous to the flight of aircraft may exist at specified times.
DATA CONVENTION	An agreed set of rules governing the manner or sequence in which a set of data may be combined into a meaningful communication.
DATA LINK COMMUNICATIONS	A form of communication intended for the exchange of messages via a data link.
DATA LINK INITIATION CAPABILITY (DLIC)	A data link application that provides the ability to exchange addresses, names and version numbers necessary to initiate data link applications.
DATA PROCESSING	A systematic sequence of operations performed on data. <i>Note. – Examples of operations are the merging, sorting, computing or any other transformation or rearrangement with the object of extracting or revising information, or of altering the representation of information.</i>
DATA QUALITY	A degree or level of confidence that the data provided meets the requirements of the data user in terms of accuracy, resolution and integrity.
DATUM	Any quantity or set of quantities that may serve as a reference or basis for the calculation of other quantities.

DECISION ALTITUDE (DA) or DECISION HEIGHT (DH)	<p>A specified altitude, or height, in the precision approach or approach with vertical guidance at which a missed approach must be initiated if the required visual reference to continue the approach has not been established.</p> <p><i>Note 1. — Decision altitude (DA) is referenced to mean sea level and decision height (DH) is referenced to the threshold elevation.</i></p> <p><i>Note 2. — The required visual reference means that section of the visual aids or of the approach area which should have been in view for sufficient time for the pilot to have made an assessment of the aircraft position and rate of change of position, in relation to the desired flight path.</i></p> <p><i>Note 3—For convenience where both expressions are used they may be written in the form “decision altitude/height” and abbreviated “DA/H”.</i></p>
DECLARED CAPACITY	<p>A measure of the ability of the ATC system or any of its subsystems or operating positions to provide service to aircraft during normal activities. It is expressed as the number of aircraft entering a specified portion of airspace in a given period of time, taking due account of weather, ATC unit configuration, staff and equipment available, and any other factors that may affect the workload of the controller responsible for the airspace.</p>
DEPENDENT PARALLEL APPROACHES	<p>Simultaneous approaches to parallel or near-parallel instrument runways where ATS surveillance system separation minima between aircraft on adjacent extended runway centre lines are prescribed.</p>
DETRESFA	<p>The code word used to designate a distress phase.</p>
DISCRETE CODE	<p>A four-digit SSR code with the last two digits not being "00".</p>
DISTRESS PHASE	<p>A situation wherein there is reasonable certainty that an aircraft and its occupants are threatened by grave and imminent danger or require immediate assistance.</p>
DME DISTANCE	<p>The line of sight distance (slant range) from the source of a DME signal to the receiving antenna.</p>
DME SEPARATION	<p>Spacing of aircraft in terms of distance determined by reference to distance measuring equipment.</p>

E

ELEVATION	The vertical distance of a point or a level, on or affixed to the surface of the earth, measured from mean sea level.
EMERGENCY PHASE	A generic term meaning, as the case may be uncertainty phase, alert phase or distress phase.
ESTIMATED ELAPSED TIME	The estimated time required to proceed from one significant point to another.
ESTIMATED OFF-BLOCK TIME	The estimated time at which the aircraft will commence movement associated with departure.
ESTIMATED TIME OF ARRIVAL	For IFR flights, the time at which it is estimated that the aircraft will arrive over that designated point, defined by reference to navigation aids, from which it is intended that an instrument approach procedure will be commenced, or if no navigation aid is associated with the aerodrome, the time at which the aircraft will arrive over the aerodrome. For VFR flights, the time at which it is estimated that the aircraft will arrive over the aerodrome.
EXPECTED APPROACH TIME	The time at which ATC expects that an arriving aircraft, following a delay, will leave the holding point to complete its approach for a landing. <i>Note. – The actual time of leaving the holding point will depend upon the approach clearance.</i>
EXPECTED ONWARD CLEARANCE TIME	The time at which it is expected that an aircraft held en-route, will leave the holding point to continue on its flight.

F

FILED FLIGHT PLAN (FPL)	The flight plan as filed with an ATS unit by the pilot or his designated representative, without any subsequent changes. <i>Note. – When the word “message” is used as a suffix to this term, it denotes the content and format of the filed flight plan data as transmitted.</i>
--------------------------------	--

FINAL APPROACH	<p>That part of an instrument approach procedure which commences at the specified final approach fix or point, or where such a fix or point is not specified,</p> <p>a) at the end of the last procedure turn, base turn or inbound turn of a racetrack procedure, if specified; or</p> <p>b) at the point of interception of the last track specified in the approach procedure; and</p> <p>ends at a point in the vicinity of an aerodrome from which:</p> <p>1) a landing can be made; or</p> <p>2) a missed approach procedure is initiated.</p>
FIX	<p>A geographical position determined by visual reference to the surface of the earth; by reference to one or more radio navigational aids; by celestial plotting, or by any other navigational device.</p>
FLIGHT CREW MEMBER	<p>A licensed crew member charged with duties essential to the operation of an aircraft during a flight duty period.</p>
FLIGHT INFORMATION CENTRE	<p>A unit established to provide flight information service and alerting service.</p>
FLIGHT INFORMATION REGION (FIR)	<p>An airspace of defined dimensions within which flight information service and alerting service are provided.</p>
FLIGHT INFORMATION SERVICE	<p>A service provided for the purpose of giving advice and information useful for the safe and efficient conduct of flights.</p>
FLIGHT LEVEL	<p>A surface of constant atmospheric pressure which is related to a specific pressure datum, 1013.2 hectopascals (hPa), and is separated from other such surfaces by specific pressure intervals.</p> <p><i>Note 1: A pressure type altimeter calibrated in accordance with the Standard Atmosphere:</i></p> <p>a) when set to a QNH altimeter setting, will indicate altitude;</p> <p>b) when set to QFE altimeter setting, will indicate height above the QFE reference datum;</p> <p>c) when set to a pressure of 1 013.2 hPa, may be used to indicate flight levels.</p> <p><i>Note 2: The terms "height" and "altitude", used in Note 1 above, indicate altimetric rather than geometric heights and altitudes.</i></p>

FLIGHT PATH MONITORING	The use of ATS surveillance systems for the purpose of providing aircraft with information and advice relative to significant deviations from nominal flight path, including deviations from terms of their air traffic control clearances.
FLIGHT PLAN	Specified information provided to air traffic services units, relative to an intended flight or portion of a flight of an aircraft. <i>Note. – Specifications for flight plans are contained in Annex 2. A Model Flight Plan Form is contained in Appendix 2 to this document.</i>
FLIGHT VISIBILITY	The visibility forward from the cockpit of an aircraft in flight.
FLOW CONTROL	Measures designed to adjust the flow of traffic into a given airspace, along a given route, or bound for a given aerodrome, so as to ensure the most effective utilisation of the airspace.
FORCED LANDING	Landing performed not in accordance with the flight plan, as a result of engine failure and/or malfunctioning.
FORECAST	A statement of expected meteorological conditions for a specified time or period, and for a specified area or portion of airspace.
FORMATION FLIGHT	Flight during which two or more aircraft fly close to each other in the same direction with full coordination between them and one of the aircraft is the leader.
G	
GENERAL AIR TRAFFIC	Flights operating in accordance with civil air traffic services procedures.
GEODETIC DATUM	A minimum set of parameters required to define location and orientation of the local reference system with respect to the global reference system/frame.
GLIDE PATH	A descent profile determined for vertical guidance during a final approach.

GREGORIAN CALENDAR	<p>Calendar in general use; first introduced in 1582 to define a year that more closely approximates the tropical year than the Julian calendar.</p> <p><i>Note: In the Gregorian calendar, common years have 365 days and leap years 366 days divided into twelve sequential months.</i></p>
GROUND EFFECT	<p>A condition of improved performance (lift) due to the interference of the surface with the airflow pattern of the rotor system when a helicopter or other VTOL aircraft is operating near the ground.</p> <p><i>Note: Rotor efficiency is increased by ground effect to a height of about one rotor diameter for most helicopters.</i></p>
GROUND VISIBILITY	<p>The visibility of an aerodrome as reported by an accredited observer or automatic systems.</p>
H	
HEADING	<p>The direction in which the longitudinal axis of an aircraft is pointed, usually expressed in degrees from North (true, magnetic, compass or grid).</p>
HEIGHT	<p>The vertical distance of a level, a point or an object considered as a point, measured from a specified datum.</p>
HOLDING FIX	<p>A geographical location that serves as a reference for a holding procedure.</p>
HOLDING PROCEDURE	<p>A predetermined manoeuvre which keeps an aircraft within a specified airspace while awaiting further clearance.</p>
HOT SPOT	<p>A location on the aerodrome movement area with a history or potential risk of collision or runway incursion, and where heightened attention by pilots/drivers is necessary.</p>
HUMAN FACTORS PRINCIPLES	<p>Principles which apply to aeronautical design, certification, training, operations and maintenance and which seek safe interface between the human and other system components by proper consideration to human performance.</p>
HUMAN PERFORMANCE	<p>Human capabilities and limitations which have impact on safety and efficiency of aeronautical operations.</p>

I

IDENTIFICATION	The situation which exists when the position indication of a particular aircraft is seen on a situation display and positively identified.
IFR	A symbol used to designate the instrument flight rules.
IFR FLIGHT	A flight conducted in accordance with the instrument flight rules.
IMC	The symbol used to designate instrument meteorological conditions.
INCERFA	The word used to designate an uncertainty phase.
INCIDENT	<p>An occurrence, other than an accident, associated with the operation of an aircraft which affects or could affect the safety of operation.</p> <p><i>Note. – The type of incidents which are of main interest to ICAO for accident prevention studies are listed in Annex 13, Attachment C.</i></p>
INDEPENDENT PARALLEL APPROACHES	Simultaneous approaches to parallel or near-parallel instrument runways where radar separation minima between aircraft on adjacent extended runway centre lines are not prescribed.
INDEPENDENT PARALLEL DEPARTURES	Simultaneous departures from parallel or near-parallel instrument runways.
INITIAL APPROACH SEGMENT	That segment of an instrument approach procedure between the initial approach fix and the intermediate approach fix or, where applicable, the final approach fix or point.

**INSTRUMENT APPROACH
PROCEDURE**

A series of predetermined manoeuvres by reference to flight instruments with specified protection from obstacles from the initial approach fix or, where applicable from the beginning of defined arrival route, to a point from which a landing can be completed and thereafter, if a landing is not completed, to a position at which holding or en-route obstacle clearance criteria apply. Instrument approach procedures are classified as follows:

Non-precision approach (NPA) procedure. An instrument approach procedure which utilizes lateral guidance but does not utilize vertical guidance.

Approach procedure with vertical guidance (APV). An instrument procedure which utilizes lateral and vertical guidance but does not meet the requirements established for precision approach and landing operations.

Precision approach (PA) procedure. An instrument approach procedure using precision lateral and vertical guidance with minima as determined by the category of operation.

Note 1: The specified minima for visual meteorological conditions are contained in Chapter 3 of Annex 2.

Note 2: In a control zone, a VFR flight may proceed under instrument meteorological conditions if and as authorized by air traffic control.

**INSTRUMENT
METEOROLOGICAL
CONDITIONS (IMC)**

Meteorological conditions expressed in terms of visibility, distance from cloud, and ceiling, less than the minima specified for visual meteorological conditions.

Note: The specified minima for visual meteorological conditions are contained in Annex 2.

INSTRUMENT RUNWAY

One of the following types of runways intended for the operation of aircraft using instrument approach procedures:

(a) NON-PRECISION APPROACH RUNWAY

An instrument runway served by visual aids and a non-visual aid providing at least directional guidance adequate for a straight-in approach.

(b) PRECISION APPROACH RUNWAY, CATEGORY I -

An instrument runway served by ILS and visual aids intended for operations down to 60 m (200 ft) decision height and down to an RVR of the order of 800m.

(c) PRECISION APPROACH RUNWAY, CATEGORY II -

An instrument runway served by ILS and visual aids intended for operations down to 30 m (100 ft) decision height and down to an RVR of the order of 400m.

(d) PRECISION APPROACH RUNWAY, CATEGORY III -

An instrument runway served by ILS to and along the surface of the runway and:-

A: intended for operations down to an RVR of the order of 200 m (no decision height being applicable) using visual aids during the final phase of landing;

B: intended for operations down to an RVR of the order of 50 m (no decision height being applicable) using visual aids for taxiing;

C: intended for operations without reliance on visual reference for landing or taxiing.

**INTEGRITY
(AERONAUTICAL DATA)**

A degree of assurance that an aeronautical data and its value has not been lost nor altered since the data origination or authorized amendment.

**INTERNATIONAL NOTAM
OFFICE**

An office designated by a State for the exchange of NOTAM internationally.

K**KNOWN TRAFFIC**

Traffic which is in communication with or the current flight details and intentions of which are known to the controller concerned.

L**LANDING AREA**

That part of a movement area intended for the landing or take-off of aircraft.

LANDING SEQUENCE

The order in which arriving aircraft are positioned for landing.

LEVEL

A generic term relating to the vertical position of an aircraft in flight and meaning variously height, altitude or flight level.

LOCATION INDICATOR

A four-letter code group formulated in accordance with rules prescribed by ICAO and assigned to the location of an aerodrome fixed station.

M**MANOEUVRING AREA**

That part of an aerodrome to be used for the take-off, landing and taxiing of aircraft, excluding aprons.

**MANUAL OF STANDARDS –
LICENSING OF AIR TRAFFIC
CONTROL PERSONNEL**

The Manual of Standards – Licensing of Air Traffic Control Personnel published under paragraph 62A(3B) of the Air Navigation Order (Cap. 6, O 2).

MESSAGE FIELD

An assigned area of a message containing specified elements of data.

METEOROLOGICAL INFORMATION	Meteorological report, analysis, forecast and any other statement relating to existing or expected meteorological conditions.
METEOROLOGICAL OFFICE	An office designated to provide meteorological service for international air navigation.
METEOROLOGICAL INFORMATION	Meteorological report, analysis, forecast and any other statement relating to existing or expected meteorological conditions.
METEOROLOGICAL OFFICE	An office designated to provide meteorological service for international air navigation.
METEOROLOGICAL REPORT	A statement of observed meteorological conditions related to a specified time and location.
MINIMUM DESCENT ALTITUDE/HEIGHT	<p>A specified altitude/height in a non-precision approach or circling approach below which descent must not be made without the required visual reference.</p> <p><i>Note 1: — Minimum descent altitude (MDA) is referenced to mean sea level and minimum descent height (MDH) is referenced to the aerodrome elevation or to the threshold elevation if that is more than 2 m (7 ft) below the aerodrome elevation. A minimum descent height for a circling approach is referenced to the aerodrome elevation.</i></p> <p><i>Note 2: — The required visual reference means that section of the visual aids or of the approach area which should have been in view for sufficient time for the pilot to have made an assessment of the aircraft position and rate of change of position, in relation to the desired flight path. In the case of a circling approach the required visual reference is the runway environment.</i></p>
MINIMUM FUEL	The term used to describe a situation in which an aircraft's fuel supply has reached a state where the flight is committed to land at a specific aerodrome and no additional delay can be accepted.
MINIMUM SECTOR ALTITUDE	The lowest altitude which may be used under emergency conditions which will provide a minimum clearance of 300 metres above all objects located in an area contained within a sector of a circle of 46 km (25 nm) radius centred on a radio aid to navigation.
MISSED APPROACH PROCEDURE	The procedure to be followed if the approach cannot be continued.

MODE (SSR)	The conventional identifier related to specific function of the interrogation signals transmitted by an SSR interrogator. There are 4 modes specified in ICAO Annex 10: A, C, S and intermode.
MOVEMENT AREA	That part of an aerodrome to be used for the take-off, landing and taxiing of aircraft, consisting of the manoeuvring area and the apron(s).
MULTILATERATION (MLAT) SYSTEM	A group of equipment configured to provide position derived from the secondary surveillance radar (SSR) transponder signals (replies and squitters) primarily using time difference of arrival (TDOA) techniques. Additional information, including identification, can be extracted from the received signals.
N	
NAVIGATION SPECIFICATION	A set of aircraft and flight crew requirements needed to support performance-based navigation operations within a defined airspace. There are two kinds of navigation specifications: <i>RNP specification.</i> A navigation specification based on area navigation that includes the requirement for performance monitoring and alerting, designated by the prefix RNP, e.g. RNP 4, RNP APCH. <i>RNAV specification.</i> A navigation specification based on area navigation that does not include the requirement for performance monitoring and alerting, designated by the prefix RNAV, e.g. RNAV 5, RNAV 1.
NEAR-PARALLEL RUNWAYS	Non-intersecting runways whose extended centre lines have an angle of convergence/divergence of 15 degrees or less.
NEXT DATA AUTHORITY	The ground system so designated by the current data authority through which an onward transfer of communications and control can take place.
NORMAL OPERATING ZONE (NOZ)	Airspace of defined dimensions extending to either side of an ILS course centre line. Only the inner half of the normal operating zone is taken into account in independent parallel approaches.

NOTAM	A notice distributed by means of telecommunication containing information concerning the establishment, condition or change in any aeronautical facility, service, procedure or hazard, the timely knowledge of which is essential to personnel concerned with flight operations.
NO TRANSGRESSION ZONE (NTZ)	In the context of independent parallel approaches, a corridor of airspace of defined dimensions located centrally between the two extended runway centre lines, where a penetration by an aircraft requires a controller intervention to manoeuvre any threatened aircraft on the adjacent approach.
O	
OBSTACLE	All fixed (whether temporary or permanent) and mobile objects, or parts thereof, that are located on an area intended for the surface movement of aircraft or that extend above a defined surface intended to protect aircraft in flight.
OBSTACLE CLEARANCE ALTITUDE (OCA) or OBSTACLE CLEARANCE HEIGHT (OCH)	<p>The lowest altitude or the lowest height or the elevation of the relevant runway threshold or the aerodrome elevation as applicable, used in establishing compliance with appropriate obstacle clearance criteria.</p> <p><i>Note 1: — Obstacle clearance altitude is referenced to mean sea level and obstacle clearance height is referenced to the threshold elevation or in the case of non-precision approaches to the aerodrome elevation or the threshold elevation if that is more than 2 m (7 ft) below the aerodrome elevation. An obstacle clearance height for a circling approach is referenced to the aerodrome elevation.</i></p> <p><i>Note 2: — For convenience when both expressions are used they may be written in the form "obstacle clearance altitude/height" and abbreviated "OCA/H".</i></p>
OBSTACLE FREE ZONE (OFZ)	The airspace above the inner approach surface, inner transitional surfaces and balked landing surface and that position of the strip bounded by these surfaces, which is not penetrated by any fixed obstacle other than a low mass and frangibly mounted one required for air navigation purposes.
OPERATIONAL AIRCRAFT	All military aircraft operated in the defensive, offensive and support role.
OPERATIONAL CONTROL	The exercise of authority over the initiation, continuation, diversion or termination of a flight in the interest of the safety of the aircraft and the regularity and efficiency of the flight.

OPERATOR	A person, organization or enterprise engaged in or offering to engage in an aircraft operation.
P	
PERFORMANCE-BASED COMMUNICATION (PBC)	Communication based on performance specifications applied to the provision of air traffic services.
PERFORMANCE-BASED NAVIGATION (PBN)	Area navigation based on performance requirements for aircraft operating along an ATS route, on an instrument approach procedure or in a designated airspace. <i>Note.— Performance requirements are expressed in navigation specifications (RNAV specification, RNP specification) in terms of accuracy, integrity, continuity, availability and functionality needed for the proposed operation in the context of a particular airspace concept.</i>
PERFORMANCE-BASED SURVEILLANCE (PBS)	Surveillance based on performance specifications applied to the provision of air traffic services.
PILOT-IN-COMMAND	The pilot designated by the operator, or in the case of general aviation, the owner, as being in command and charged with the safe conduct of a flight.
POSITION INDICATION	The visual indication, in non-symbolic and/or symbolic form, on a situation display, of the position of an aircraft, aerodrome vehicle or other object.
POSITION SYMBOL	The visual indication in symbolic form, on a situation display, of the position of an aircraft, aerodrome vehicle or other object, obtained after automatic processing of positional data derived from any source.
PRECAUTIONARY APPROACH	A procedure designed to afford a military pilot experiencing flight difficulties a means of landing safely and expeditiously.
PRECIPITATION	Any or all forms of water particles whether liquid or solid, that fall from the atmosphere and reach the surface. It is a major class of hydrometeor, distinguished from cloud and virga in that it must reach the surface of the earth.
PRESSURE-ALTITUDE	An atmospheric pressure expressed in terms of altitude which corresponds to that pressure in the Standard Atmosphere (as defined in Annex 8).
PRIMARY RADAR	A radar system which uses reflected radio signals.

PRIMARY SURVEILLANCE RADAR (PSR)	A surveillance radar system which uses reflected radio signals.
PRINTED COMMUNICATIONS	Communications which automatically provide a permanent printed record at each terminal of a circuit of all messages which pass over such circuit.
PROCEDURAL CONTROL	Term used to indicate that information derived from an ATS surveillance system is not required for provision of air traffic control service.
PROCEDURAL SEPARATION	The separation used when providing procedural control.
PROCEDURE TURN	<p>A manoeuvre in which a turn is made away from a designated track followed by a turn in the opposite direction to permit the aircraft to intercept and proceed along the reciprocal of the designated track.</p> <p><i>Note 1. – Procedure turns are designated “left” or “right” according to the direction of the initial turn.</i></p> <p><i>Note 2. – Procedure turns may be designated as being made either in level flight or while descending, according to the circumstances of each individual procedure.</i></p>
PROFILE	The orthogonal projection of a flight path or portion thereof on the vertical surface containing the nominal track.
PROHIBITED AREA	An airspace of defined dimensions above the land areas or territorial waters of a state within which the flight of aircraft is prohibited.
PSR BLIP	The visual indication, in non-symbolic form, on a radar display of the position of an aircraft obtained by primary radar.
Q	
QUADRANTAL CRUISING LEVEL	Specified cruising levels determined in relation to magnetic track within quadrants of the compass.
R	
RADAR	A radio detection device which provides information on range, azimuth and/or elevation of objects.
RADAR APPROACH	An approach, in which the final approach phase is executed under the direction of a controller using radar.

RADAR CLUTTER	The visual indication on a radar display of unwanted signals.
RADAR CONTACT	The situation which exists when the radar position of a particular aircraft is seen and identified on a situation display.
RADAR HANDOVER	Transfer of responsibility for the control of aircraft between two controllers using radar, following identification of the aircraft by both controllers.
RADAR SEPARATION	The separation used when aircraft position information is derived from radar sources.
RADAR SURVEILLANCE	Observation of the movements of aircraft on a radar display and the passing of advice and information to identified aircraft and, where appropriate, to other ATS units.
RADIO NAVIGATION SERVICE	A service providing guidance information or position data for the efficient and safe operation of aircraft supported by one or more radio navigation aids.
RADIOTELEPHONY	A form of radiocommunication primarily intended for the exchange of information in the form of speech.
RAMP CONTROL SERVICE	A service provided by the ANSP to manage the activities and movement of aircraft and vehicles at the apron comprising of the following functions: <ol style="list-style-type: none">start-up clearance to aircraft;push-back clearance to aircraft;taxi and towing clearance to aircraft on apron taxiways;control of vehicular movements on apron taxiways.
READBACK	A procedure whereby a receiving station repeats a received message or an appropriate thereof back to the transmitting station so as to obtain confirmation of correct reception.
RECEIVING UNIT/CONTROLLER	Air traffic services unit/air traffic controller to which a message is sent. <i>Note. – See definition of “sending unit/controller”.</i>
REPETITIVE FLIGHT PLAN (RPL)	A flight plan related to a series of frequently recurring, regularly operated individual flights with identical basic features, submitted by an operator for retention and

repetitive use by ATS units.

REPORTING POINT

A specified geographical location in relation to which the position of an aircraft can be reported.

**REQUIRED
COMMUNICATION
PERFORMANCE (RCP)**

A set of requirements for air traffic service provision and associated ground equipment, aircraft capability, and operations needed to support performance-based communication.

**REQUIRED NAVIGATION
PERFORMANCE (RNP)**

A statement of the navigation performance accuracy necessary for operation within a defined airspace.

Note. – Navigation performance and requirements are defined for a particular RNP type and or application.

**REQUIRED SURVEILLANCE
PERFORMANCE
SPECIFICATION (RSP)**

A set of requirements for air traffic service provision and associated ground equipment, aircraft capability, and operations needed to support performance-based surveillance.

**RESCUE COORDINATION
CENTRE**

A unit responsible for promoting efficient organisation of search and rescue service and for coordinating the conduct of search and rescue operations within a search and rescue region.

RESCUE UNIT

A unit composed of trained personnel and provided with equipment suitable for the expeditious conduct of search and rescue.

RESTRICTED AREA

An airspace of defined dimensions above the land areas or territorial waters of a state within which the flight of aircraft is restricted in accordance with certain specified conditions.

RNP TYPE

A containment value expressed as a distance in nautical miles from the intended position within which flights would be for at least 95 per cent of the total flying time.

Example. – RNP4 represents a navigation accuracy of plus or minus 7.4km (4NM) on a 95 percent containment basis.

ROUTE SEGMENT

A route or portion of route usually flown without an intermediate stop.

RUNWAY

A defined rectangular area on a land aerodrome selected or prepared for the landing and take-off of aircraft.

RUNWAY-HOLDING

A designated position intended to protect a runway, an

POSITION	obstacle limitation surface, or an ILS/MLS critical/sensitive area at which taxiing aircraft and vehicles shall stop and hold, unless otherwise authorized by the aerodrome control tower. <i>Note.— In radiotelephony phraseologies, the expression “holding point” is used to designate the runway-holding position.</i>
RUNWAY INCURSION	Any occurrence at an aerodrome involving the incorrect presence of an aircraft, vehicle or person on the protected area of a surface designated for the landing and take-off of aircraft.
RUNWAY VISUAL RANGE	The range over which the pilot of an aircraft on the centre line of a runway can see the runway surface markings or the lights delineating the runway or identifying its centre line.
S	
SAFETY MANAGEMENT SYSTEM (SMS)	A systematic approach to managing safety, including the necessary organizational structures, accountabilities, policies and procedures.
SAFETY PROGRAMME	An integrated set of regulations and activities aimed at improving safety.
SEARCH AREA	The area in which an aircraft is believed to have crashed or forced landed.
SECONDARY RADAR	A radar system wherein a radio signal transmitted from the radar station initiates the transmission of a radio signal from another station.
SECONDARY SURVEILLANCE RADAR (SSR)	A surveillance radar system which uses transmitters /receivers (interrogators) and transponders.
SEGREGATED PARALLEL OPERATIONS	Simultaneous operations on parallel or near-parallel instrument runways in which one runway is used exclusively for approaches and the other runway is used exclusively for departures.
SENDING UNIT/CONTROLLER	Air traffic services unit/air traffic controller transmitting a message. <i>Note. – See definition of “receiving unit/controller”.</i>
SHORELINE	A line following the general contour of the shore, except that in cases of inlets or bays less than 30

nautical miles in width, the line shall pass directly across the inlet or bay to intersect the general contour on the opposite side.

SIGMET INFORMATION

Information issued by a meteorological watch office concerning the occurrence or expected occurrence of specified en-route weather and other phenomena in the atmosphere that may affect the safety of aircraft operations.

SIGNIFICANT POINT

A specified geographical location used in defining an ATS route or the flight path of an aircraft and for other navigation and ATS purposes.

Note: — There are three categories of significant points: ground-based navigation aid, intersection and waypoint. In the context of this definition, intersection is a significant point expressed as radials, bearings and/or distances from ground-based navigation aids.

SITUATION DISPLAY

An electronic display depicting the position and movement of aircraft and other information as required.

SIMULTANEOUS IFR APPROACH

Radar vectoring of aircraft for simultaneous ILS approaches to parallel runways.

SPECIAL VFR FLIGHT

A VFR flight cleared by air traffic control to operate within a control zone in meteorological conditions below VMC.

SSR RESPONSE

The visual indication, in non-symbolic form, on a radar display, of a response from an SSR transponder in reply to an interrogation.

STANDARD INSTRUMENT ARRIVAL (STAR)

A designated instrument flight rule (IFR) arrival route linking a significant point, normally on an ATS route, with a point from which a published instrument approach procedure can be commenced.

STANDARD INSTRUMENT DEPARTURE (SID)

A designated instrument flight rule (IFR) departure route linking the aerodrome or a specified runway of the aerodrome with a specified significant point, normally on a designated ATS route, at which the en-route phase of a flight commences.

STOPWAY

A defined rectangular area on the ground at the end of take-off run available prepared as a suitable area in which an aircraft can be stopped in the case of an abandoned take-off.

SURVEILLANCE RADAR

Radar equipment used to determine the position of an aircraft in range and azimuth.

**SURVEILLANCE RADAR
APPROACH**

An approach to an aerodrome or a runway by an aircraft under the direction of a radar controller using surveillance radar.

T**TAXIING**

Movement of an aircraft on the surface of an aerodrome under its own power, excluding take-off and landing.

TAXIWAY

A defined path on a land aerodrome established for the taxiing of aircraft and intended to provide a link between one part of the aerodrome and another, including:

- (a) Aircraft stand taxilane. A portion of an apron designated as a taxiway and intended to provide access to aircraft stands only.
- (b) Apron taxiway. A portion of a taxiway system located on an apron and intended to provide a through taxi route across the apron.
- (c) Rapid exit taxiway. A taxiway connected to a runway at an acute angle and designed to allow landing aeroplanes to turn off at higher speeds than are achieved on other exit taxiways and thereby minimizing runway occupancy times.

TERMINAL CONTROL AREA

A control area normally established at the confluence of ATS routes in the vicinity of one or more major aerodromes.

THRESHOLD

The beginning of that portion of the runway usable for landing.

**TIME DIFFERENCE OF
ARRIVAL (TDOA)**

The difference in relative time that a transponder signal from the same aircraft (or ground vehicle) is received at different receivers.

**TOTAL ESTIMATED
ELAPSED TIME**

For IFR flights, the estimated time required from take-off to arrive over that designated point, defined by reference to navigation aids, from which it is intended that an instrument approach procedure will be commenced, or, if no navigation aid is associated with the destination aerodrome, to arrive over the destination aerodrome. For VFR flights, the estimated time required from take-off to arrive over the destination aerodrome.

TOUCHDOWN

The point where the nominal glide path intercepts the runway.

Note: — Touchdown as defined above is only a datum and is not necessarily the actual point at which the aircraft will touch the runway.

TRACK	The projection on the earth's surface of the path of an aircraft, the direction of which path at any point is usually expressed in degrees from North (true, magnetic or grid).
TRAFFIC AVOIDANCE ADVICE	Advice provided by an air traffic services unit specifying manoeuvres to assist a pilot to avoid a collision.
TRAFFIC INFORMATION	Information issued by an air traffic services unit to alert a pilot to other known or observed air traffic which may be in proximity to the position or intended route of flight and to help the pilot avoid a collision.
TRANSFER OF CONTROL	Transfer of responsibility for providing air traffic control service.
TRANSFER OF CONTROL POINTS	A defined point located along the flight path of an aircraft, at which the responsibility for providing air traffic control service to the aircraft is transferred from one control unit or control position to the next.
TRANSFERRING UNIT	Air traffic control unit/air traffic controller in the process of transferring the responsibility for providing air traffic control service to an aircraft to the next air traffic control unit/air traffic controller along the route of flight.
TRANSITION ALTITUDE	The altitude at or below which the vertical position of an aircraft is controlled by reference to altitudes.
TRANSITION LAYER	The airspace between the transition altitude and the transition level.
TRANSITION LEVEL	The lowest flight level available for use above the transition altitude.
U	
UNCERTAINTY PHASE	A situation wherein uncertainty exists as to the safety of an aircraft and its occupants.
UNLAWFUL INTERFERENCE	An unlawful attempt, successful or otherwise, being made to take over control of an aircraft, or any act of violence against an aircraft being committed, attempted or threatened.

UNMANNED FREE BALLOON	<p>A non-power-driven, unmanned, lighter-than-air aircraft in free flight.</p> <p><i>Note.</i>— <i>Unmanned free balloons are classified as heavy, medium or light in accordance with specifications contained in Annex 2, Appendix 4.</i></p>
V	
VECTORIZING	<p>Provision of navigation guidance to aircraft in the form of specific headings, based on the use of an ATS surveillance system.</p>
VFR	<p>The symbol used to designate the visual flight rules.</p>
VFR FLIGHT	<p>A flight conducted in accordance with the visual flight rules.</p>
VIDEO MAPPING	<p>The electronic superimposing of a map or plan on a radar display.</p>
VISIBILITY	<p>Visibility for aeronautical purposes is the greater of:</p> <ul style="list-style-type: none">(a) the greatest distance at which a black object of suitable dimensions, situated near the ground, can be seen and recognised when observed against a bright background;(b) the greatest distance at which lights in the vicinity of 1,000 candelas can be seen and identified against an unlit background. <p><i>Note 1:</i> — <i>The two distances have different values in air of a given extinction coefficient and the latter (b) varies with the background illumination. The former (a) is represented by the meteorological optical range (MOR).</i></p> <p><i>Note 2:</i> — <i>The definition applies to the observations of visibility in local routine and special reports, to the observations of prevailing and minimum visibility reported in METAR and SPECI and to the observations of ground visibility.</i></p>
VISUAL APPROACH	<p>An approach by an IFR flight when either part or all of an instrument approach procedure is not completed and the approach is executed in visual reference to terrain.</p>
VISUAL APPROACH (CIRCLING)	<p>The visual phase of flight, after completing an instrument approach, to bring the aircraft into position for landing on a runway which is not suitably located for straight-in approach.</p>

VISUAL METEOROLOGICAL CONDITIONS Meteorological conditions expressed in terms of visibility, distance from cloud and ceiling, equal to or better than specified minima.

Note.— The specified minima are contained in Annex 2, Chapter 4.

VISUAL SURVEILLANCE SYSTEM An electro-optical system providing an electronic visual presentation of traffic and any other information necessary to maintain situational awareness at an aerodrome and its vicinity.

VMC The symbol used to designate visual meteorological conditions.

W

WAKE TURBULENCE CONDITIONS The disturbance to the surrounding atmosphere created by an operating aircraft and may be used to refer to any or all of the following:

- (a) Jet-engine blast
- (b) Prop wash
- (c) Wing-tip vortices
- (d) Rotor vortices

WAYPOINT A specified geographical location used to define an area navigation route or the flight path of an aircraft employing area navigation. Waypoints are identified as either:

Fly-by waypoint. A waypoint which requires turn anticipation to allow tangential interception of the next segment of a route or procedure, or

Flyover waypoint. A waypoint at which a turn is initiated in order to join the next segment of a route or procedure.

WIND SHEAR A change in wind speed and/or direction in space, including updrafts and downdrafts.

Chapter 2

ATS ORGANISATION REQUIREMENTS

2.1 Safety Management System

- 2.1.1 The ANSP shall implement a safety management system (SMS) acceptable to the ANS Regulator that, as a minimum:
- a) identifies safety hazards;
 - b) ensures the implementation of remedial action necessary to maintain agreed safety performance;
 - c) provides for continuous monitoring and regular assessment of the safety performance; and
 - d) aims at a continuous improvement of the overall performance of the safety management system.
- 2.1.2 The framework for the implementation and maintenance of a safety management system must include, as a minimum, the elements as listed in Appendix 10.
- 2.1.3 A safety management system shall clearly define lines of safety accountability throughout the air traffic services provider, including a direct accountability for safety on the part of senior management.
- 2.1.4 All activities undertaken in an ATS SMS shall be fully documented. All documentation shall be kept for a minimum of 3 years.
- 2.1.5 The ANSP shall submit the SMS manual and relevant materials to illustrate its implementation to the ANS Regulator for acceptance.
- 2.1.6 The ANSP shall submit any amendments to the SMS manual to the ANS Regulator for acceptance in a timely manner prior to implementation.
- 2.1.7 The ANSP must establish and implement a mechanism to review and mitigate any deficiencies identified for Singapore within the framework of ICAO's Planning and Implementation Regional Group. Where there are such deficiencies, the ANSP must inform the ANS Regulator immediately, and provide periodic updates on the actions taken by the ANSP to address such deficiencies until they are eliminated or mitigated to a level acceptable by the ANS regulator.
- 2.1.8 The ANSP shall propose safety performance indicators (SPIs), alert levels and target levels for the ANS Regulator's agreement. These shall:

- a) be pertinent to the ANSP's aviation activities;
- b) be commensurate with the scope and complexity of the ANSP's aviation activities.
- c) be congruent with the relevant safety indicators in the Singapore State Safety Programme; and
- d) include a combination of high and lower-consequence SPIs as appropriate.

2.1.9 The ANSP shall submit a report on its achievement of the SPIs to the ANS Regulator on an agreed time interval.

2.1.10 The ANSP shall establish and maintain a hazard database for the analysis of the hazards.

2.2 [Reserved]

2.3 [Reserved]

2.4 [Reserved]

2.5 SAFETY REVIEWS

2.5.1 General requirements

2.5.1.1 The ANSP must conduct systematic safety reviews of each of its ATC units at least once a year. The safety reviews are to be conducted by qualified personnel who is trained and experienced in the unit under review and is familiar with the relevant Standards and Recommended Practices (SARPs), Procedures for Air Navigation Services (PANS), safe operating practices and Human Factors principles.

2.5.2 Scope

2.5.2.1 The scope of ATC units' safety reviews should include at least the following issues:

Regulatory issues to ensure that:

- a) ATC operations manuals, ATC unit instructions and air traffic control (ATC) coordination procedures are complete, concise, and up-to-date;
- b) the ATS route structure, where applicable, provides for:
 - 1) adequate route spacing; and
 - 2) crossing points for ATS routes located so as to reduce the need for controller intervention and for inter-and intra-unit coordination;

- c) the separation minima used in the airspace or at the aerodrome are appropriate and all the provisions applicable to those minima are being complied with;
- d) where applicable, provision is made for adequate observation of the manoeuvring area, and procedures and measures aimed at minimizing the potential for inadvertent runway incursions are in place. This observation may be performed visually or by means of an ATS surveillance system;
- e) Appropriate procedures for low visibility aerodrome operations are in place;
- f) Traffic volumes and associated controller workloads do not exceed defined, safe levels and that procedures are in place for regulating traffic volumes whenever necessary;
- g) Procedures to be applied in the event of failures or degradations of ATS systems, including communications, navigation and surveillance systems, are practicable and will provide for an acceptable level of safety; and
- h) Procedures for the reporting of incidents and other safety-related occurrences are implemented, that the reporting of incidents is encouraged and that such reports are reviewed to identify the need for any remedial action.

Operational and technical issues to ensure that:

- a) The environmental working conditions meet established levels for temperature, humidity, ventilation, noise and ambient lighting, and do not adversely affect controller performance;
- b) Automation systems generate and display flight plan, control and coordination data in a timely, accurate and easily recognizable manner and in accordance with Human Factors principles;

Note.— The ANSP should take into account relevant human factors aspects when designing or certifying equipment and operating procedures and when training and licensing personnel.

- c) Equipment, including input/output devices for automation systems, are designed and positioned in the working position in accordance with ergonomic principles;
- d) Communications, navigation, surveillance and other safety significant systems and equipment;
 - 1) are tested for normal operations on a routine basis;
 - 2) meet the required level of reliability and availability as defined by the ANSP and accepted by AAR;

- 3) provide for the timely and appropriate detection and warning of system failures and degradation;
 - 4) Include documentation on the consequences of system, sub-system and equipment failures and degradations;
 - 5) Include measures to control the probability of failures and degradations; and
 - 6) Include adequate back-up facilities and/or procedures in the event of a system failure or degradation; and
- e) Detailed records of systems and equipment serviceability are kept and periodically reviewed.

Note. — In the context above, the terms reliability and availability have the following meanings:

1) *Reliability.* The probability that a device or system will function without failure over a specified time period or amount of usage; and

2) *Availability.* The ratio of the percentage of the time that a system is operating correctly to the total time in that period.

Licensing and training issues to ensure that:

- a) Controllers are adequately trained and properly licensed with valid ratings;
- b) Controller competency is maintained by adequate and appropriate refresher training, including the handling of aircraft emergencies and operations under conditions with failed and degraded facilities and systems;
- c) Controllers, where the ATC unit/control sector is staffed by teams, are provided relevant and adequate training in order to ensure efficient teamwork;
- d) The implementation of new or amended procedures, and new or updated communications, surveillance and other safety significant systems and equipment is preceded by appropriate training and instruction;
- e) Controller competency in the English language is satisfactory in relation to providing ATS to international air traffic; and
- f) Standard phraseology is used.

2.6 [Reserved]

2.7 [Reserved]

2.8 Human Resources Management

2.8.1 Objective

2.8.1.1 To ensure that human resources are properly managed with a view to minimizing their contribution to accident/incident in the provision of ATM services.

2.8.2 Requirement

2.8.2.1 The ANSP shall systematically address human resources management in the following key aspects:

- (i) Management responsibilities and accountabilities;
- (ii) Staff deployment;
- (iii) Operational watch rostering; and
- (iv) Operational support arrangements.

2.8.2.2 The ANSP should identify the key personnel responsible for the safe conduct of the ATM services. Their positions, responsibilities, functions, accountabilities and authorities are to be clearly defined. The ANSP should also develop job descriptions for other ATS staff & technical staff. Organization chart indicating the specific responsibilities should be provided.

2.8.2.3 The ANSP must document its policies and procedures used for determining its staffing levels to ensure the provision of a safe ATS system.

2.8.2.4 The ANSP shall deploy sufficient number of personnel with valid air traffic controller licences to provide ATC at the ATC units.

2.8.2.4.1 The ANSP shall ensure that only personnel with valid air traffic controller licences are permitted to perform ATC service in accordance with the rating as endorsed on their licence unless such personnel is engaged in On-the-Job Training (OJT) which is conducted in accordance with the ANSP's procedures.

2.8.2.5 The ANSP should plan the level of ATC staffing requirements taking into account the following factors:

- (i) Training requirements;
- (ii) Rest days or rest periods between shifts;
- (iii) Leave requirements;
- (iv) Sick leave reserve;
- (v) Traffic volume, pattern and trend; and

(vi) Mid- to long-term projection on the development of ATM system.

2.8.2.6 The ANSP should ensure that adequate operations support staff are trained and maintained to fill established positions of the organization so as to fulfill the necessary functions, such as Flight Service Officers by providing them with adequate training and that their proficiency should be checked on a recurrent basis.

2.8.2.7 The ANSP should develop policies and procedures to enable recruitment and retention of adequate ATS staff.

2.9 Training and assessment for air traffic controllers

2.9.1 General

Note: The terms “training” and “assessment” in this section of the MOS-ATS refers to the training described under paragraph 2.9.2; requirements regarding the training and assessment that lead to an ATC licence may be found in the MOS-PEL and MOS-ATCTO.

2.9.1.1 The ANSP shall document its policies and procedures on training and assessment of its air traffic controllers in an appropriate manual.

2.9.1.2 The ANSP shall establish a process for the timely amendment of this manual and bringing the amendments to the notice of the relevant staff and to the ANS Regulator within a reasonable period of time.

2.9.1.3 The ANSP shall establish the competencies and performance criteria required of its air traffic controllers.

2.9.2 Requirements on training

2.9.2.1 The ANSP shall establish an appropriate training programme for its air traffic controllers to maintain the competency of its air traffic controllers. The ANSP shall review its training programme periodically to ensure that it remains relevant.

2.9.2.2 The ANSP shall ensure that recurrent training is provided to its air traffic controllers where appropriate. The recurrent training shall include, but is not limited to, the handling of aircraft emergencies and operations under conditions with failed and degraded facilities and systems.

2.9.2.3 The ANSP shall ensure that its air traffic controllers are provided with appropriate training in order to ensure efficient teamwork.

2.9.2.4 The ANSP shall ensure that its air traffic controllers are appropriately trained prior to the implementation of changes to ATC systems and procedures.

2.9.2.5 The ANSP shall ensure that an air traffic controller who performs operational instructional duties, including those related to recency requirements stated

under paragraph 2.9.4.2, fulfill the requirements as an On-The-Job Training Instructor (OJTI) as stated under paragraph 3.1.3.3 of the Manual of Standards – Licensing of Air Traffic Control Personnel.

2.9.3 Requirements on assessments

2.9.3.1 The ANSP shall ensure that an annual assessment (i.e. proficiency checks) is conducted on each of its air traffic controllers during his deployment as operational air traffic controller, to ensure that he continues to possess the required competencies.

2.9.3.2 The ANSP shall implement and establish a mechanism to monitor the operational performance of its air traffic controllers.

2.9.3.3 The ANSP shall submit a monthly report to the ANS Regulator containing:

- (a) a summary of the results of the annual assessments (referred to in 2.9.3.1) done in the month, and follow-up actions where appropriate; and
- (b) a summary of the operational performance monitoring (referred to in 2.9.3.2) done in the month, and follow-up actions where appropriate.

2.9.4 Requirements on recency

2.9.4.1 The ANSP must ensure each air traffic controller whom it deploys to provide air traffic services fulfils the recency requirements for the skill sets required for their air traffic controller ratings.

2.9.4.2 For the purpose of paragraph 2.9.4.1, the ANSP must establish a recency programme which shall specify:

- (a) the ATC skill sets required for each rating;
- (b) a minimum of 10 hours of duty to be accumulated for each rating in a preceding 60-day period by an air traffic controller;
- (c) the mechanism, which may include re-training, supervision and assessment, for ensuring that an air traffic controller fulfils the requirements referred to in subparagraph (b); and
- (d) the mechanism to monitor an air traffic controller's suitability to be deployed.

2.9.4.3 The ANSP must:

- (a) submit the recency programme mentioned in paragraph 2.9.4.2 to the ANS Regulator for the ANS Regulator's acceptance before the programme is implemented;
- (b) document the recency programme in the ANSP's operations manual; and

- (c) submit details of any change to the recency programme to the ANS Regulator for acceptance prior to the implementation of the changes.

2.10 Requirements for aeronautical station operators

2.10.1 The ANSP shall ensure that every aeronautical station operator meets the following requirements:

- a) Be not less than 18 years of age at the point of initial deployment;
- b) Shall have completed training, and have demonstrated a level of knowledge that is acceptable to the ANSP, in at least the following subjects:
 - i. General knowledge of air traffic services provided within Singapore;
 - ii. Operational procedures (i.e. radiotelephony procedures, phraseology, telecommunication network);
 - iii. Applicable rules and regulations; and
 - iv. Telecommunication equipment (i.e. principles, use and limitations of relevant telecommunication equipment).
- c) Shall have demonstrated the ability to speak and understand the language used for radiotelephony communications minimally to the level of ICAO Operational Level (Level 4) of the ICAO Language Proficiency Rating Scale;
- d) Shall have completed On-the-Job training, and have demonstrated a level of competency that is acceptable to the ANSP, in at least the following areas:
 - i. Operating the relevant telecommunications equipment in use; and
 - ii. Transmitting and receiving radiotelephony messages with efficiency and accuracy.

Note: Aeronautical station operators are in charge of communications between aircraft and air traffic controllers in oceanic areas where HF radio communications are used.

2.10.2 The ANSP shall establish and implement a mechanism to formally evaluate *the language proficiency of its aeronautical station operators who have demonstrated a language proficiency below Expert Level (Level 6) at intervals in accordance with the person's demonstrated proficiency level, as follows:*

- a) those demonstrating language proficiency at the Operational Level (Level 4) shall be evaluated at least once every three years; and
- b) those demonstrating language proficiency at the Extended Level (Level 5) shall be evaluated at least once every six years.

CHAPTER 3

ATS SYSTEM CAPACITY AND AIR TRAFFIC FLOW MANAGEMENT

3.1 Capacity Management

3.1.1 General

3.1.1.1 In order to ensure that the number of aircraft provided with an ATC service does not exceed that which can be safely handled by the ATC unit concerned under the prevailing circumstances, the ANSP must determine the declared capacity for each area and approach control sector and each aerodrome.

3.1.1.2 The ANSP must also document its methodologies for determining the declared capacities, which shall take into consideration factors such as weather-related factors, ATC unit configuration, staff and equipment available, and any other factors that may affect the workload of a controller responsible for that control sector or aerodrome.

3.1.1.3 The ANSP must implement air traffic flow management (ATFM) measures for airspace where air traffic demand at times exceeds, or is expected to exceed, the declared capacity.

3.1.1.4 In implementing any measures to increase its declared capacity, the ANSP must apply its SMS procedures to ensure that safety levels are not jeopardized.

3.1.1.5 The ANSP must periodically review its ATC capacities to ensure that the declared capacities continue to be relevant

3.1.2 Capacity assessment

3.1.2.1 In assessing capacity values, factors to be taken into account should include, *inter alia*:

- a) the level and type of ATS provided;
- b) the structural complexity of the control area, the control sector or the aerodrome concerned;
- c) controller workload, including control and coordination tasks to be performed;
- d) the types of communications, navigation and surveillance systems in

use, their degree of technical reliability and availability as well as the availability of back-up systems and/or procedures;

- e) availability of ATC systems providing controller support and alert functions; and
- f) any other factor or element deemed relevant to controller workload.

Note:- Summaries of techniques which may be used to estimate control sector/position capacities are contained in the Air Traffic Services Planning Manual (Doc 9426).

3.1.3 Regulation of ATC capacity and traffic volumes

3.1.3.1 Where traffic demand varies significantly on a daily or periodic basis, facilities and procedures should be implemented to vary the number of operational sectors or working positions to meet the prevailing and anticipated demand. Applicable procedures should be contained in local instructions.

3.1.3.2 In case of particular events which have a negative impact on the declared capacity of an airspace or aerodrome, the capacity of the airspace or aerodrome concerned shall be reduced accordingly for the required time period. Whenever possible, the capacity pertaining to such events should be pre-determined.

3.1.3.3 To ensure that safety is not compromised whenever the traffic demand in an airspace or at an aerodrome is forecast to exceed the available ATC capacity, measures shall be implemented to regulate traffic volumes accordingly.

3.1.4 Enhancement of ATC capacity

3.1.4.1 The ANSP should:

- a) periodically review ATS capacities in relation to traffic demand; and
- b) provide for flexible use of airspace in order to improve the efficiency of operations and increase capacity.

3.1.4.2 In the event that traffic demand regularly exceeds ATC capacity, resulting in continuing and frequent traffic delays, or it becomes apparent that forecast traffic demand will exceed capacity values, the ANSP should, as far as practicable:

- a) implement steps aimed at maximizing the use of the existing system capacity; and
- b) develop plans to increase capacity to meet the actual or forecast demand.

3.1.5 Flexible use of airspace

3.1.5.1 The appropriate authorities should, through the establishment of agreements and procedures, make provision for the flexible use of all airspace in order to increase airspace capacity and to improve the efficiency and flexibility of aircraft operations.

3.1.5.2 Agreements and procedures providing for a flexible use of airspace should specify, *inter alia*:

- a) the horizontal and vertical limits of the airspace concerned;
- b) the classification of any airspace made available for use by civil air traffic;
- c) units or authorities responsible for transfer of the airspace;
- d) conditions for transfer of the airspace to the ATC unit concerned;
- e) conditions for transfer of the airspace from the ATC unit concerned;
- f) periods of availability of the airspace;
- g) any limitations on the use of the airspace concerned; and
- h) any other relevant procedures or information.

3.2 AIR TRAFFIC FLOW MANAGEMENT

3.2.1 General

3.2.1.1 An air traffic flow management (ATFM) service shall be implemented for airspace where traffic demand at times exceeds the defined ATC capacity.

3.2.1.2 Certain flights may be exempt from ATFM measures, or be given priority over other flights.

3.2.2 Flow management procedures

3.2.2.1 ATFM should be carried out in three phases:

- a) *strategic planning*, if the action is carried out more than one day before the day on which it will take effect. Strategic planning is normally carried out well in advance, typically two to six months ahead;
- b) *pre-tactical planning*, if the action to be taken on the day before the day on which it will take effect;

- c) *tactical operations*, if the action is taken on the day on which it will take effect.

3.2.3 Strategic planning

3.2.3.1 Strategic planning should be carried out in conjunction with ATC and the aircraft operators. It should consist of examining the demand for the forthcoming season, assessing where and when demand is likely to exceed the available ATC capacity and taking steps to resolve the imbalance by:

- a) arranging with the ANSP to provide adequate capacity at the required place and time;
- b) re-routing certain traffic flows (traffic orientation);
- c) scheduling or rescheduling flights as appropriate; and
- d) identifying the need for tactical ATFM measures.

3.2.3.2 Where traffic orientation scheme (TOS) is to be introduced, the routes should, as far as practicable, minimize the time and distance penalties for the flights concerned, and allow some degree of flexibility in the choice of routes, particularly for long-range flights.

3.2.3.3 When a TOS has been agreed, details should be published by the ANSP concerned in a common format.

3.2.4 Pre-tactical planning

3.2.4.1 Pre-tactical planning should entail fine tuning of the strategic plan in the light of updated demand data. During this phase:

- a) certain traffic flows may be re-routed;
- b) off-load routes may be coordinated;
- c) tactical measures will be decided upon; and
- d) details for the ATFM plan for the following day should be published and made available to all concerned.

3.2.5 Tactical operations

3.2.5.1 Tactical ATFM operations should consist of:

- a) executing the agreed tactical measures in order to provide a reduced and even flow of traffic where demand would otherwise

have exceeded capacity;

- b) monitoring the evolution of the air traffic situation to ensure that the ATFM measures applied are having the desired effect and to take or initiate remedial action when long delays are reported, including re-routing of traffic and flight level allocation, in order to utilize the available ATC capacity to the maximum extent.

3.2.5.2 When the traffic demand exceeds, or is foreseen to exceed, the capacity of a particular sector or aerodrome, the responsible ATC unit shall advise the responsible ATFM unit, where such a unit is established, and other ATC units concerned. Flight crews of aircraft planned to fly in the affected area and operators should be advised, as soon as practicable, of the delays expected or the restrictions which will be applied.

Note:- Operators known or believed to be concerned will normally be advised by the regional air traffic flow management service, when established.

3.2.6 Liaison

3.2.6.1 During all phases of ATFM the responsible units should liaise closely with ATC and the aircraft operators in order to ensure an effective and equitable service.

Note:- Attention is drawn to the guidance material contained in the Air Traffic Services Planning Manual (Doc 9426) regarding flow control as well as to procedures contained in the Regional Supplementary Procedures (Doc 7030) and regional ATFM Handbooks.

Chapter 4

GENERAL PROVISIONS FOR AIR TRAFFIC SERVICES

4.0 ESTABLISHMENT OF AUTHORITY

4.01 The ANSP shall determine those portions of the airspace and aerodromes where air traffic services will be provided. They shall arrange for such services to be established and provided in accordance with the provisions of this Manual. Where air traffic services are established, information shall be published as necessary to permit the utilization of such services.

4.1 RESPONSIBILITY FOR THE PROVISION OF AIR TRAFFIC CONTROL SERVICE

4.1.1 Area control service

4.1.1.1 Area control service shall be provided:

- a) by an area control centre (ACC); or
- b) by the unit providing approach control service in a control zone or in a control area of limited extent which is designated primarily for the provision of approach control service, when no ACC is established.

4.1.2 Approach control service

4.1.2.1 Approach control service shall be provided:

- a) by an aerodrome control tower or an ACC, when it is necessary or desirable to combine under the responsibility of one unit the functions of the approach control service and those of the aerodrome control service or the area control service; or
- b) by an approach control unit, when it is necessary or desirable to establish a separate unit.

Note.— Approach control service may be provided by a unit co-located with an ACC, or by a control sector within an ACC.

4.1.3 Aerodrome control service

4.1.3.1 Aerodrome control service shall be provided by an aerodrome control tower.

Note:- Specifications for flight information region, control areas and control zones, including the minimum flight altitudes, shall be effected in accordance with the provisions of ICAO Annex 11. Areas of responsibility for the control of flights on airways and the units providing this service, as well as control zones dimensions and controlling authorities, shall be specified in AIP Singapore.

4.1.4 Objectives of the air traffic services

4.1.4.1 The objectives of the air traffic services shall be to:

- a) prevent collisions between aircraft;
- b) prevent collisions between aircraft on the manoeuvring area and obstructions on that area;
- c) expedite and maintain an orderly flow of air traffic;
- d) provide advice and information useful for the safe and efficient conduct of flights;
- e) notify appropriate organizations regarding aircraft in need of search and rescue aid, and assist such organizations as required.

4.1.5 Classification of airspaces

4.1.5.1 The ANSP shall select the airspace classes appropriate to their needs. The requirements for flights within each class shall be in accordance with Appendix 4 of ICAO Annex 11.

4.1.6 Establishment and identification of ATS routes

4.1.6.1 When ATS routes are established, a protected airspace along each ATS route and a safe spacing between adjacent ATS routes shall be provided. Designators for ATS routes shall be in accordance with the principles found in ICAO Annex 11, *Appendix 1*. Standard departure and arrival routes and associated procedures shall be identified in accordance with Annex 11, *Appendix 3*.

4.1.7 Establishment and identification of significant points

4.1.7.1 Significant points shall be established for the purpose of defining an ATS route and/or in relation to the requirements of air traffic services for information regarding the progress of aircraft in flight. Significant points shall be identified by designators. Significant points shall be established and identified in accordance with the principles set forth in Annex 11, *Appendix 2*.

4.1.8 Establishment and identification of standard routes for taxiing aircraft

4.1.8.1 Standard routes for taxiing aircraft should be established on an aerodrome between runways, aprons and maintenance areas. Such routes should be direct, simple and where practicable, designed to avoid traffic conflicts. Standard routes for taxiing aircraft should be identified by designators distinctively different from those of the runways and ATS routes.

4.1.9 Aeronautical data

4.1.9.1 The determination and reporting of air traffic services-related aeronautical data with the accuracy and integrity requirements shall be in accordance with the provisions of ICAO Annex 11, Chapter 2.

4.2 RESPONSIBILITY FOR THE PROVISION OF FLIGHT INFORMATION SERVICE AND ALERTING SERVICE

4.2.1 Flight information service and alerting service shall be provided as follows:

- a) *within a flight information region (FIR)*: by a flight information centre, unless the responsibility for providing such services is assigned to an air traffic control unit having adequate facilities for the exercise of such responsibilities;
- b) *within controlled airspace and at controlled aerodromes*: by the relevant air traffic control units.

Note: - A flight information region shall be delineated to cover the whole of the air route structure and shall include all airspace within its lateral limits.

4.3 DIVISION OF RESPONSIBILITY FOR CONTROL BETWEEN AIR TRAFFIC CONTROL UNITS

4.3.1 General

4.3.1.1 The ANSP must designate the area of responsibility for each air traffic control (ATC) unit and, when applicable, for individual control sectors within an ATC unit. Where there is more than one ATC working position within a unit or sector, the duties and responsibilities of the individual working positions shall be defined.

4.3.2 Between a unit providing aerodrome control service and a unit providing approach control service

4.3.2.1 Except for flights which are provided aerodrome control service only, the control of arriving and departing controlled flights shall be divided between units providing aerodrome control service and units providing approach control service as follows:

4.3.2.1.1 *Arriving aircraft.* Control of an arriving aircraft shall be transferred from the unit providing approach control service to the unit providing aerodrome control service when the aircraft:

- a) is in the vicinity of the aerodrome, and
 - 1) it is considered that approach and landing will be completed in visual reference to the ground, or
 - 2) has reached uninterrupted visual meteorological conditions, or
- b) is at a prescribed point or level, or
- c) has landed,

as specified in ATS unit instructions.

4.3.2.1.2 Transfer of communications to the aerodrome controller should be effected at such a point, level or time that clearance to land or alternative instructions, as well as information on essential local traffic, can be issued in a timely manner.

Note.— Even though there is an approach control unit, control of certain flights may be transferred directly from an ACC to an aerodrome control tower and vice versa, by prior arrangement between the units concerned for the relevant part of approach control service to be provided by the ACC or the aerodrome control tower, as applicable.

4.3.2.1.3 *Departing aircraft.* Control of a departing aircraft shall be transferred from the unit providing aerodrome control service to the unit providing approach control service:

- a) when visual meteorological conditions prevail in the vicinity of the aerodrome:

- 1) prior to the time the aircraft leaves the vicinity of the aerodrome,
- 2) prior to the aircraft entering instrument meteorological conditions, or
- 3) when the aircraft is at a prescribed point or level,

as specified in ATS unit instructions;

b) when instrument meteorological conditions prevail at the aerodrome:

- 1) immediately after the aircraft is airborne, or
- 2) when the aircraft is at a prescribed point or level,

as specified in local instructions.

Note.— See Note following 4.3.2.1.2.

4.3.3 Between a unit providing approach control service and a unit providing area control service

4.3.3.1 When area control service and approach control service are not provided by the same air traffic control unit, responsibility for controlled flights shall rest with the unit providing area control service except that a unit providing approach control service shall be responsible for the control of:

- a) arriving aircraft that have been released to it by the ACC;
- b) departing aircraft until such aircraft are released to the ACC.

4.3.3.2 A unit providing approach control service shall assume control of arriving aircraft, provided such aircraft have been released to it, upon arrival of the aircraft at the point, level or time agreed for transfer of control, and shall maintain control during approach to the aerodrome.

4.3.4 Between two units providing area control service

4.3.4.1 The responsibility for the control of an aircraft shall be transferred from a unit providing area control service in a control area to the unit providing area control service in an adjacent control area at the time of crossing the common control area boundary as estimated by the ACC having control of the aircraft or at such other point, level or time as has been agreed between the two units.

4.3.5 Between control sectors/positions within the same air traffic control unit

4.3.5.1 The responsibility for the control of an aircraft shall be transferred from one control sector/position to another control sector/position within the same ATC unit at a point, level or time, as specified in local instructions.

4.4 FLIGHT PLAN

Note.— Procedures for the use of repetitive flight plans are contained in Chapter 16, Section 16.4.

4.4.1. Flight Plan Form

4.4.1.1. A flight plan form based on the model in **Appendix 2** should be provided and should be used by operators and air traffic services units for the purpose of completing flight plans.

Note.— A different form may be provided for use in completing repetitive flight plan listings.

4.4.1.2 The flight plan form should be printed in English.

4.4.1.3 Operators and air traffic services units should comply with the instructions for completion of the flight plan form and the repetitive flight plan listing form given in **Appendix 2**.

4.4.1.4 An operator shall, prior to departure:

- a) ensure that, where the flight is intended to operate on a route or in an area where a required navigation performance (RNP) type is prescribed, the aircraft has an appropriate RNP approval, and that all conditions applying to that approval will be satisfied; and
- b) ensure that, where operation in reduced vertical separation minimum (RVSM) airspace is planned, the aircraft has the required RVSM approval. The letter W shall be inserted in Item 10 (Equipment) of the flight plan if the aircraft and operator have received RVSM State approval, regardless of the requested flight level. The aircraft registration shall be inserted in Item 18 of the flight plan.

Note.— Operators must obtain airworthiness and operational approval from the State of Registry or State of the Operator, as appropriate, to conduct RVSM operations (see AIP Singapore ENR 1.8-2).

- c) ensure that, where the flight is intended to operate where an RCP type is prescribed, the aircraft has an appropriate RCP approval, and that all conditions applying to that approval will be satisfied.

4.4.2 Submission of a flight plan

4.4.2.1 Information relative to an intended flight or portion of a flight, to be provided to air traffic services units, shall be in the form of a flight plan.

4.4.2.2 A flight plan shall be submitted prior to operating:

- a) any flight or portion thereof to be provided with air traffic control service;

- b) any flight within or into designated areas, or along designated routes to facilitate the provision of flight information, alerting and search and rescue services;
- c) any flight within or into designated areas, or along designated routes to facilitate coordination with appropriate military units or with air traffic services units in adjacent States in order to avoid the possible need for interception for the purpose of identification;
- d) any flight across international borders.

4.4.2.3 PRIOR TO DEPARTURE

4.4.2.3.1 Except when other arrangements have been made for submission of repetitive flight plans, a flight plan submitted prior to departure should be submitted to the aeronautical information service at the departure aerodrome. A flight plan for a flight to be provided with air traffic control service shall be submitted at least sixty minutes before departure.

4.4.2.3.2 In the event of a delay of 30 minutes in excess of the estimated off-block time for a controlled flight or a delay of one hour for an uncontrolled flight for which a flight plan has been submitted, the flight plan should be amended or a new flight plan submitted and the old flight plan cancelled, whichever is applicable.

4.4.2.4 DURING FLIGHT

4.4.2.4.1 A flight plan to be submitted during flight should normally be transmitted to the ATS unit in charge of the FIR or control area in or on which the aircraft is flying, or in or through which the aircraft wishes to fly or to the aeronautical telecommunication station serving the air traffic services unit concerned. When this is not practicable, it should be transmitted to another ATS unit or aeronautical telecommunication station for retransmission as required to the appropriate air traffic services unit.

4.4.2.4.2 The submission of flight plan during flight should ensure its receipt by the appropriate air traffic services unit at least ten minutes before the aircraft is estimated to reach:

- a) the intended point of entry into a control area; or
- b) the point of crossing an airway.

4.4.3 Acceptance of a flight plan

4.4.3.1 The first ATS unit receiving a flight plan, or change thereto, shall:

- a) check it for compliance with the format and data conventions;
- b) check it for completeness and, to the extent possible, for accuracy;

- c) take action, if necessary, to make it acceptable to the air traffic services;
and
- d) indicate acceptance of the flight plan or change thereto, to the originator.

4.5 AIR TRAFFIC CONTROL CLEARANCES

4.5.1 Scope and purpose

4.5.1.1 Clearances are issued solely for expediting and separating air traffic and are based on known traffic conditions which affect safety in aircraft operation. Such traffic conditions include not only aircraft in the air and on the manoeuvring area over which control is being exercised, but also any vehicular traffic or other obstructions not permanently installed on the manoeuvring area in use.

4.5.1.2 If an air traffic control clearance is not suitable to the pilot-in-command of an aircraft, the flight crew may request and, if practicable, obtain an amended clearance.

4.5.1.3 The issuance of air traffic control clearances by air traffic control units constitutes authority for an aircraft to proceed only in so far as known air traffic is concerned. ATC clearances do not constitute authority to violate any applicable regulations for promoting the safety of flight operations or for any other purpose; neither do clearances relieve a pilot-in-command of any responsibility whatsoever in connection with a possible violation of applicable rules and regulations.

4.5.1.4 ATC units shall issue such ATC clearances as are necessary to prevent collisions and to expedite and maintain an orderly flow of air traffic.

4.5.1.5 ATC clearances must be issued early enough to ensure that they are transmitted to the aircraft in sufficient time for it to comply with them.

4.5.2 Aircraft subject to ATC for part of flight

4.5.2.1 When a flight plan specifies that the initial portion of a flight will be uncontrolled, and that the subsequent portion of the flight will be subject to ATC, the aircraft shall be advised to obtain its clearance from the ATC unit in whose area controlled flight will be commenced.

4.5.2.2 When a flight plan specifies that the first portion of a flight will be subject to ATC, and that the subsequent portion will be uncontrolled, the aircraft shall normally be cleared to the point at which the controlled flight terminates.

4.5.3 Flights through intermediate stops

4.5.3.1 When an aircraft files, at the departure aerodrome, flight plans for the various stages of flight through intermediate stops, the initial clearance limit will be the

first destination aerodrome and new clearances shall be issued for each subsequent portion of flight.

4.5.3.2 The flight plan for the second stage, and each subsequent stage, of a flight through intermediate stops will become active for ATS and search and rescue (SAR) purposes only when the appropriate ATS unit has received notification that the aircraft has departed from the relevant departure aerodrome, except as provided for in 4.5.3.3.

4.5.3.3 By prior arrangement between ATC units and the operators, aircraft operating on an established schedule may if the proposed route of flight is through more than one control area, be cleared through intermediate stops within other control areas but only after coordination between the ACCs concerned.

4.5.4 Contents of clearances

4.5.4.1 Clearances shall contain positive and concise data and shall, as far as practicable, be phrased in a standard manner.

4.5.4.2 Clearances shall, except as provided for in Chapter 6, Section 6.3.2, concerning standard departure clearances, contain the items specified in Chapter 11, 11.4.2.5.2.1.

4.5.5 Departing aircraft

4.5.5.1 ACCs shall, except where procedures providing for the use of standard departure clearances have been implemented, forward a clearance to approach control units or aerodrome control towers with the least possible delay after receipt of request made by these units, or prior to such request if practicable.

4.5.6 En-route aircraft

4.5.6.1 GENERAL

4.5.6.1.1 An ATC unit may request an adjacent ATC unit to clear aircraft to a specified point during a specified period.

4.5.6.1.2 After the initial clearance has been issued to an aircraft at the point of departure, it will be the responsibility of the appropriate ATC unit to issue an amended clearance whenever necessary and to issue traffic information, if required.

4.5.7 Description of air traffic control clearances

4.5.7.1 CLEARANCE LIMIT

4.5.7.1.1 A clearance limit shall be described by specifying the name of the appropriate significant point, or aerodrome, or controlled airspace boundary.

4.5.7.1.2 When prior coordination has been effected with units under whose control the aircraft will subsequently come, or if there is reasonable assurance that it can be effected a reasonable time prior to their assumption of control, the clearance limit shall

be the destination aerodrome or, if not practicable, an appropriate intermediate point, and coordination shall be expedited so that a clearance to the destination aerodrome may be issued as soon as possible.

4.5.7.1.3 If an aircraft has been cleared to an intermediate point in adjacent controlled airspace, the appropriate ATC unit will then be responsible for issuing, as soon as practicable, an amended clearance to the destination aerodrome.

4.5.7.1.4 When the destination aerodrome is outside controlled airspace, the ATC unit responsible for the last controlled airspace through which an aircraft will pass shall issue the appropriate clearance for flight to the limit of that controlled airspace.

4.5.7.2 ROUTE OF FLIGHT

4.5.7.2.1 The route of flight shall be detailed in each clearance when deemed necessary. The phrase “cleared via flight planned route” may be used to describe any route or portion thereof, provided the route or portion thereof is identical to that filed in the flight plan and sufficient routing details are given to definitely establish the aircraft on its route. The phrases “cleared via (designation) departure” or “cleared via (designation) arrival” may be used when standard departure or arrival routes have been established and published in Singapore Aeronautical Information Publication (AIP).

4.5.7.2.2 The phrase “cleared via flight planned route” shall not be used when granting a reclearance.

4.5.7.2.3 Subject to airspace constraints, ATC workload and traffic density, and provided coordination can be effected in a timely manner, an aircraft should whenever possible be offered the most direct routing.

4.5.7.3 LEVELS

Except as provided for in Chapter 6, 6.3.2 and 6.5.1.5, use of standard departure and arrival clearances, instructions included in clearances relating to levels shall consist of the items specified in Chapter 11, 11.4.2.5.2.2.

4.5.7.4 CLEARANCE OF A REQUESTED CHANGE IN FLIGHT PLAN

4.5.7.4.1 When issuing a clearance covering a requested change in route or level, the exact nature of the change shall be included in the clearance.

4.5.7.4.2 When traffic conditions will not permit clearance of a requested change, the word “UNABLE” shall be used. When warranted by circumstances, an alternative route or level should be offered.

4.5.7.4.3 When an alternative route is offered and accepted by the flight crew under the procedures described in 4.5.7.4.2, the amended clearance issued shall describe the route to the point where it joins the previously cleared route, or, if the aircraft will not re-join the previous route, to the destination.

4.5.7.5 READ-BACK OF CLEARANCES

4.5.7.5.1 The flight crew shall read back to the air traffic controller safety-related parts of ATC clearances and instructions which are transmitted by voice. The following items shall always be read back:

- a) ATC route clearances;
- b) clearances and instructions to enter, land on, take off from, hold short of, cross, taxi and backtrack on any runway; and
- c) runway-in-use, altimeter settings, SSR codes, level instructions, heading and speed instructions and, whether issued by the controller or contained in automatic terminal information service (ATIS) broadcasts, transition levels.

Note.— If the level of an aircraft is reported in relation to standard pressure 1 013.2 hPa, the words “FLIGHT LEVEL” precede the level figures. If the level of the aircraft is reported in relation to QNH/QFE, the figures are followed by the word “FEET”.

4.5.7.5.1.1 Other clearances or instructions, including conditional clearances, shall be read back or acknowledged in a manner to clearly indicate that they have been understood and will be complied with.

4.5.7.5.2 The controller shall listen to the read-back to ascertain that the clearance or instruction has been correctly acknowledged by the flight crew and shall take immediate action to correct any discrepancies revealed by the read-back.

4.5.7.5.2.1 Unless specified by the ANSP, voice read-back of controller-pilot data link communications (CPDLC) messages shall not be required.

Note.— The procedures and provisions relating to the exchange and acknowledgement of CPDLC messages are contained in ICAO Annex 10, Volume II and the PANS-ATM, Chapter 14.

4.6 HORIZONTAL SPEED CONTROL INSTRUCTIONS

4.6.1 General

4.6.1.1 In order to facilitate a safe and orderly flow of traffic, aircraft may be instructed to adjust speed in a specified manner. Flight crews should be given adequate notice of planned speed control.

Note 1.— Application of speed control over a long period of time may affect aircraft fuel reserves.

Note 2.— Provisions concerning longitudinal separation using the Mach number technique are contained in Chapter 5, Separation methods and minima.

4.6.1.2 Speed control shall not be applied to aircraft entering or established in a holding pattern.

4.6.1.3 Speed adjustments should be limited to those necessary to establish and/or maintain a desired separation minimum or spacing. Instructions involving frequent changes of speed, including alternate speed increases and decreases, should be avoided.

4.6.1.4 The flight crew shall inform the ATC unit concerned if at any time they are unable to comply with a speed instruction. In such cases, the controller shall apply an alternative method to achieve the desired spacing between the aircraft concerned.

4.6.1.5 At levels at or above FL 250, speed adjustments should be expressed in multiples of 0.01 Mach; at levels below FL 250, speed adjustments should be expressed in multiples of 10 knots based on indicated airspeed (IAS).

Note 1.— Mach 0.01 equals approximately 6 kt IAS at higher flight levels.

Note 2.— When an aircraft is heavily loaded and at a high level, its ability to change speed may, in cases, be very limited.

4.6.1.6 Aircraft shall be advised when a speed control restriction is no longer required.

4.6.2 Methods of application

4.6.2.1 In order to establish a desired spacing between two or more successive aircraft, the controller should first either reduce the speed of the last aircraft, or increase the speed of the lead aircraft, then adjust the speed(s) of the other aircraft in order.

4.6.2.2 In order to maintain a desired spacing using speed control techniques, specific speeds need to be assigned to all the aircraft concerned.

Note 1.— The true airspeed (TAS) of an aircraft will decrease during descent when maintaining a constant IAS. When two descending aircraft maintain the same IAS, and the leading aircraft is at the lower level, the TAS of the leading aircraft will be lower than that of the following aircraft. The distance between the two aircraft will thus be reduced, unless a sufficient speed differential is applied. For the purpose of calculating a desired speed differential between two succeeding aircraft, 6 kt IAS per 1 000 ft height difference may be used as a general rule. At levels below 8000 ft, the difference between IAS and TAS is negligible for speed control purposes.

Note 2.— Time and distance required to achieve a desired spacing will increase with higher levels, higher speeds, and when the aircraft is in a clean configuration.

4.6.3 Descending and arriving aircraft

4.6.3.1 An aircraft should, when practicable, be authorized to absorb a period of notified terminal delay by cruising at a reduced speed for the latter portion of its flight.

4.6.3.2 An arriving aircraft may be instructed to maintain its “maximum speed”, “minimum clean speed”, “minimum speed”, or a specified speed.

Note.— “Minimum clean speed” signifies the minimum speed at which an aircraft can be flown in a clean configuration, i.e. without deployment of lift-augmentation devices, speed brakes or landing gear.

4.6.3.3 Speed reductions to less than 250 knots IAS for turbojet aircraft during initial descent from cruising level should be applied only with the concurrence of the flight crew.

4.6.3.4 Instructions for an aircraft to simultaneously maintain a high rate of descent and reduce its speed should be avoided as such manoeuvres are normally not compatible. Any significant speed reduction during descent may require the aircraft to temporarily level off to reduce speed before continuing descent.

4.6.3.5 Arriving aircraft should be permitted to operate in a clean configuration for as long as possible. Below FL 150, speed reductions for turbojet aircraft to not less than 220 knots IAS, which will normally be very close to the minimum speed of turbojet aircraft in a clean configuration, may be used.

4.6.3.6 Only minor speed adjustments not exceeding plus/minus 20 knots IAS should be used for aircraft on intermediate and final approach.

4.6.3.7 Speed control should not be applied to aircraft after passing a point 4 NM from the threshold on final approach.

Note.— The flight crew has a requirement to fly a stabilized approach (airspeed and configuration) typically by 3 NM from the threshold.

4.7 VERTICAL SPEED CONTROL INSTRUCTIONS

4.7.1 General

4.7.1.1 In order to facilitate a safe and orderly flow of traffic, aircraft may be instructed to adjust rate of climb or rate of descent. Vertical speed control may be applied between two climbing aircraft or two descending aircraft in order to establish or maintain a specific vertical separation minimum.

4.7.1.2 Vertical speed adjustments should be limited to those necessary to establish and/or maintain a desired separation minimum. Instructions involving frequent changes of climb/descent rates should be avoided.

4.7.1.3 The flight crew shall inform the ATC unit concerned if unable, at any time, to comply with a specified rate of climb or descent. In such cases, the controller shall apply an alternative method to achieve an appropriate separation minimum between aircraft, without delay.

4.7.1.4 Aircraft shall be advised when a rate of climb/descent restriction is no longer required.

4.7.2 Methods of application

4.7.2.1 An aircraft may be instructed to expedite climb or descent as appropriate to or through a specified level, or may be instructed to reduce its rate of climb or rate of descent.

4.7.2.2 Climbing aircraft may be instructed to maintain a specified rate of climb, a rate of climb equal to or greater than a specified value or a rate of climb equal to or less than a specified value.

4.7.2.3 Descending aircraft may be instructed to maintain a specified rate of descent, a rate of descent equal to or greater than a specified value or a rate of descent equal to or less than a specified value.

4.7.2.4 In applying vertical speed control, the controller should ascertain to which level(s) climbing aircraft can sustain a specified rate of climb or, in the case of descending aircraft, the specified rate of descent which can be sustained, and shall ensure that alternative methods of maintaining separation can be applied in a timely manner, if required.

Note.— Controllers need to be aware of aircraft performance characteristics and limitations in relation to a simultaneous application of horizontal and vertical speed limitations.

4.8 CHANGE FROM IFR TO VFR FLIGHT

4.8.1 Change from instrument flight rules (IFR) flight to visual flight rules (VFR) flight is only acceptable when a message initiated by the pilot-in-command containing the specific expression “CANCELLING MY IFR FLIGHT”, together with the changes, if any, to be made to the current flight plan, is received by an air traffic services unit. No invitation to change from IFR flight to VFR flight is to be made either directly or by inference.

4.8.2 No reply, other than the acknowledgment “IFR FLIGHT CANCELLED AT ... (time)”, should normally be made by an air traffic services unit.

4.8.3 When an ATS unit is in possession of information that instrument meteorological conditions are likely to be encountered along the route of flight, a pilot changing from IFR flight to VFR flight should, if practicable, be so advised.

Note.— See Chapter 11, 11.4.3.2.1.

4.8.4 An ATC unit receiving notification of an aircraft’s intention to change from IFR to VFR flight shall, as soon as practicable thereafter, so inform all other ATS units to whom the IFR flight plan was addressed, except those units through whose regions or areas the flight has already passed.

4.9 WAKE TURBULENCE CATEGORIES

Note.— The term “wake turbulence” is used in this context to describe the effect of the rotating air masses generated behind the wing tips of large jet aircraft, in preference to the term “wake vortex” which describes the nature of the air masses. Detailed characteristics of wake vortices and their effect on aircraft are contained in the Air Traffic Services Planning Manual (Doc 9426), Part II, Section 5.

4.9.1 Wake turbulence categories of aircraft

4.9.1.1 Wake turbulence separation minima shall be based on a grouping of aircraft types into three categories according to the maximum certificated take-off mass as follows:

- a) HEAVY (H) - all aircraft types of 136 000 kg or more;
- b) MEDIUM (M) - aircraft types less than 136 000 kg but more than 7 000 kg; and
- c) LIGHT (L) - aircraft types of 7 000 kg or less.

4.9.1.2 Helicopters should be kept well clear of light aircraft when hovering or while air taxiing.

Note 1.— Helicopters produce vortices when in flight and there is some evidence that, per kilogramme of gross mass, their vortices are more intense than those of fixed-wing aircraft.

Note 2.— The provisions governing wake turbulence separation minima are set forth in Chapter 5, Section 5.8 and Chapter 8, Section 8.7.3.

4.9.2 Indication of heavy wake turbulence category

4.9.2.1 For A380-800 aircraft, the letter “J” should be entered into the space allocated to wake turbulence under Item 9 of the ICAO flight plan. For A380-800 aircraft the expression “SUPER” and for aircraft in the heavy wake turbulence category the word “Heavy” should be included immediately after the aircraft call sign in the initial radiotelephony contact between such aircraft and ATS units.

*Note.— Wake turbulence categories are specified in the instructions for completing Item 9 of the flight plan in **Appendix 2**.*

4.10 ALTIMETER SETTING PROCEDURES

4.10.1 Expression of vertical position of aircraft

4.10.1.1 For flights in the vicinity of aerodromes and within terminal control areas the vertical position of aircraft shall, except as provided for in 4.10.1.2, be expressed in terms of altitudes at or below the transition altitude and in terms of light levels at or above the transition level. While passing through the transition layer, vertical position

shall be expressed in terms of flight levels when climbing and in terms of altitudes when descending.

4.10.1.2 When an aircraft which has been given clearance to land is completing its approach using atmospheric pressure at aerodrome elevation (QFE), the vertical position of the aircraft shall be expressed in terms of height above aerodrome elevation during that portion of its flight for which QFE may be used, except that it shall be expressed in terms of height above runway threshold elevation:

- a) for instrument runways, if the threshold is 2 metres (7 feet) or more below the aerodrome elevation, and
- b) for precision approach runways.

4.10.1.3 For flights en route the vertical position of aircraft shall be expressed in terms of:

- a) flight levels at or above the lowest usable flight level;
- b) altitudes below the lowest usable flight level; except where, on the basis of regional air navigation agreements, a transition altitude has been established for a specified area, in which case the provisions of 4.10.1.1 shall apply.

4.10.2 Determination of the transition level

4.10.2.1 The ATS unit shall establish the transition level to be used in the vicinity of the aerodrome(s) concerned and, when relevant, the terminal control area (TMA) concerned, for the appropriate period of time on the basis of QNH (altimeter sub-scale setting to obtain elevation when on the ground) reports and forecast mean sea level pressure, if required.

4.10.2.2 The transition level shall be the lowest flight level available for use above the transition altitude established for the aerodrome(s) concerned. Where a common transition altitude has been established for two or more aerodromes which are so closely located as to require coordinated procedures, the ATS units shall establish a common transition level to be used at any given time in the vicinity of the aerodrome and, when relevant, in the TMA concerned.

Note.— See 4.10.3.2 regarding the determination of the lowest usable flight level(s) for control areas.

4.10.3 Minimum cruising level for IFR flights

4.10.3.1 Except when specifically authorized, cruising levels below the minimum flight altitudes established by the State shall not be assigned.

4.10.3.2 ATC units shall, when circumstances warrant it, determine the lowest usable flight level or levels for the whole or parts of the control area for which they are responsible, and use it when assigning flight levels and pass it to pilots on request.

Note 1.— Unless otherwise prescribed, the lowest usable flight level is that flight level which corresponds to, or is immediately above, the established minimum flight altitude.

Note 2.— The portion of a control area for which a particular lowest usable flight level applies is determined in accordance with air traffic services requirements.

Note 3.— The objectives of the air traffic control service as prescribed in ICAO Annex 11 do not include prevention of collision with terrain. The procedures prescribed in this document do not relieve pilots of their responsibility to ensure that any clearances issued by air traffic control units are safe in this respect. When an IFR flight is vectored or is given a direct routing which takes the aircraft off an ATS route, the procedures in Chapter 8, 8.6.5.2 apply.

4.10.4 Provision of altimeter setting information

4.10.4.1 The ATS units shall at all times have available for transmission to aircraft in flight, on request, the information required to determine the lowest flight level which will ensure adequate terrain clearance on routes or segments of routes for which this information is required.

4.10.4.2 Flight information centres and ACCs shall have available for transmission to aircraft on request an appropriate number of QNH reports or forecast pressures for the FIRs and control areas for which they are responsible, and for those adjacent.

4.10.4.3 The flight crew shall be provided with the transition level in due time prior to reaching it during descent. This may be accomplished by voice communications, ATIS broadcast or data link.

4.10.4.4 The transition level shall be included in approach clearances when requested by the pilot.

4.10.4.5 A QNH altimeter setting shall be included in the descent clearance when first cleared to an altitude below the transition level, in approach clearances or clearances to enter the traffic circuit, and in taxi clearances for departing aircraft, except when it is known that the aircraft has already received the information.

4.10.4.6 A QFE altimeter setting shall be provided to aircraft on request or on a regular basis in accordance with local arrangements; it shall be the QFE for the aerodrome elevation except for:

- a) non-precision approach runways, if the threshold is 2 metres (7 feet) or more below the aerodrome elevation, and
- b) precision approach runways, in which cases the QFE for the relevant runway threshold shall be provided.

4.10.4.7 Altimeter settings provided to aircraft shall be rounded down to the nearest lower whole hectopascal.

Note 1.— Unless otherwise prescribed by the State concerned, the lowest usable flight level is that flight level which corresponds to, or is immediately above, the established minimum flight altitude.

Note 2.— The portion of a control area for which a particular lowest usable flight level applies is determined in accordance with air traffic services requirements.

Note 3.— See Foreword, Note 2 to paragraph 2.1.

4.11 POSITION REPORTING

4.11.1 Transmission of position reports

4.11.1.1 On routes defined by designated significant points, position reports shall be made by the aircraft when over, or as soon as possible after passing, each designated compulsory reporting point, except as provided in 4.11.1.3 and 4.11.3. Additional reports over other points may be requested by the ATS unit.

4.11.1.2 On routes not defined by designated significant points, position reports shall be made by the aircraft as soon as possible after the first half hour of flight and at hourly intervals thereafter, except as provided in 4.11.1.3. Additional reports at shorter intervals of time may be requested by the ATS unit.

4.11.1.3 Flights may be exempted from the requirement to make position reports at each designated compulsory reporting point or interval. In applying this, account should be taken of the meteorological requirement for the making and reporting of routine aircraft observations.

Note.— This is intended to apply in cases where adequate flight progress data are available from other sources, e.g. radar or ADS-B (see Chapter 8, 8.6.4.4), or ADS-C (see Chapter 13) and in other circumstances where the omission of routine reports from selected flights is found to be acceptable.

4.11.1.4 The position reports required by 4.11.1.1 and 4.11.1.2 shall be made to the ATS unit serving the airspace in which the aircraft is operated.

4.11.1.5 If a position report is not received at the expected time, subsequent control shall not be based on the assumption that the estimated time is accurate. Immediate action shall be taken to obtain the report if it is likely to have any bearing on the control of other aircraft.

4.11.2 Contents of voice position reports

4.11.2.1 The position reports required by 4.11.1.1 and 4.11.1.2 shall contain the following elements of information, except that elements (d), (e) and (f) may be omitted from position reports transmitted by radiotelephony:

- a) aircraft identification
- b) position
- c) time

d) flight level or altitude, including passing level and cleared level if not maintaining the cleared level

e) next position and time over

f) ensuing significant point.

4.11.2.1.1 Element (d), flight level or altitude, shall, however, be included in the initial call after a change of air-ground voice communication channel.

4.11.2.2 When assigned a speed to maintain, the flight crew shall include this speed in their position reports. The assigned speed shall also be included in the initial call after a change of air-ground voice communication channel, whether or not a full position report is required.

Note.— Omission of element d) may be possible when flight level or altitude, as appropriate, derived from pressure-altitude information can be made continuously available to controllers in labels associated with the position indication of aircraft and when adequate procedures have been developed to guarantee the safe and efficient use of this altitude information.

4.11.3 Radiotelephony procedures for air-ground voice communication channel changeover

4.11.3.1 When so prescribed by the ANSP, the initial call to an ATC unit after a change of air-ground voice communication channel shall contain the following elements:

- a) designation of the station being called;
- b) call sign and, for aircraft in the heavy wake turbulence category, the word “Super” or “Heavy”;
- c) level, including passing and cleared levels if not maintaining the cleared level;
- d) speed, if assigned by ATC; and
- e) additional elements, as required by The ANSP.

4.11.4 Transmission of ADS-C reports

4.11.4.1 The position reports shall be made automatically to the ATS unit serving the airspace in which the aircraft is operating. The requirements for the transmission and contents of automatic dependent surveillance — contract (ADS-C) reports shall be established by the controlling ATC unit on the basis of current operational conditions and communicated to the aircraft and acknowledged through an ADS-C agreement.

4.11.5 Contents of ADS-C reports

4.11.5.1 ADS-C reports shall be composed of data blocks selected from the following:

a) Aircraft Identification**b) Basic ADS-C**

latitude
longitude
altitude
time
figure of merit

c) Ground vector

track
ground speed
rate of climb or descent

d) Air vector

heading
Mach or IAS
rate of climb or descent

e) Projected profile

next waypoint
estimated altitude at next waypoint
estimated time at next waypoint
(next + 1) waypoint
estimated altitude at (next + 1) waypoint
estimated time at (next + 1) waypoint

f) Meteorological information

wind speed
wind direction
wind quality flag
temperature
turbulence (if available)
humidity (if available)

g) Short-term intent

latitude at projected intent point
longitude at projected intent point
altitude at projected intent point
time of projection

If an altitude, track or speed change is predicted to occur between the aircraft's current position and the projected intent point, additional information would be provided in an intermediate intent block as follows:

distance from current point to change point
track from current point to change point
altitude at change point

predicted time to change point

h) Extended projected profile (in response to an interrogation from the ground system)

next waypoint
 estimated altitude at next waypoint
 estimated time at next waypoint
 (next + 1) waypoint
 estimated altitude at (next + 1) waypoint
 estimated time at (next + 1) waypoint
 (next + 2) waypoint
 estimated altitude at (next + 2) waypoint
 estimated time at (next + 2) waypoint
 [repeated for up to (next + 128) waypoints]

Note. — The specifications for the elements in the meteorological information data block, including their ranges and resolutions, are shown in Appendix 3 to ICAO Annex 3.

4.11.5.2 The basic ADS-C data block shall be required from all ADS-C-equipped aircraft. Remaining ADS-C data blocks shall be included as necessary. In addition to any requirements concerning its transmission for ATS purposes, data block f) (Meteorological information) shall be transmitted in accordance with ICAO Annex 3, 5.3.1. ADS-C emergency and/or urgency reports shall include the emergency and/or urgency status in addition to the relevant ADS-C report information.

4.11.6 Data format of ADS-B messages

Note. — Data formats of ADS-B messages can be found in ICAO Annex 10 — Aeronautical Telecommunications, Volume III — Communication Systems, Part I — Digital Data Communication Systems, and Volume IV — Surveillance Radar and Collision Avoidance Systems.

4.12 REPORTING OF OPERATIONAL AND METEOROLOGICAL INFORMATION

4.12.1 General

4.12.1.1 When operational and/or routine meteorological information is to be reported, using data link, by an aircraft en route at times where position reports are required in accordance with 4.11.1.1 and 4.11.1.2, the position report shall be given in accordance with 4.11.5.2 (requirements concerning transmission of meteorological information from ADS-C equipped aircraft), or in the form of a routine air-report. Special aircraft observations shall be reported as special air-reports. All air-reports shall be reported as soon as is practicable.

4.12.2 Contents of routine air-reports

4.12.2.1 Routine air-reports transmitted by data link, when ADS-C is not being applied, shall give information relating to such of the following elements as are necessary for compliance with 4.12.2.2:

Section 1.— Position information:

- 1) aircraft identification
- 2) position
- 3) time
- 4) flight level or altitude
- 5) next position and time over
- 6) ensuing significant point

Section 2.— Operational information:

- 7) estimated time of arrival
- 8) endurance

Section 3.— Meteorological information:

- 9) wind direction
- 10) wind speed
- 11) wind quality flag
- 12) air temperature
- 13) turbulence (if available)
- 14) humidity (if available).

4.12.2.2 Section 1 of the air-report is obligatory, except that elements (5) and (6) thereof may be omitted. Section 2 of the air-report, or a portion thereof, shall only be transmitted when so requested by the operator or a designated representative, or when deemed necessary by the pilot-in-command. Section 3 of the air-report shall be transmitted in accordance with ICAO Annex 3, Chapter 5.

Note.— While element (4), flight level or altitude, may, in accordance with 4.11.2.1, be omitted from the contents of a position report transmitted by radiotelephony, that element may not be omitted from Section 1 of an air-report.

4.12.3 Contents of special air-reports

4.12.3.1 Special air-reports shall be made by all aircraft whenever the following conditions are encountered or observed:

- a) moderate or severe turbulence; or
- b) moderate or severe icing; or
- c) severe mountain wave; or

-
- d) thunderstorms, without hail that are obscured, embedded, widespread or in squall-lines; or
 - e) thunderstorms, with hail that are obscured, embedded, widespread or in squall-lines; or
 - f) heavy dust storm or heavy sandstorm; or
 - g) volcanic ash cloud; or
 - h) pre-eruption volcanic activity or a volcanic eruption.

Note.— Pre-eruption volcanic activity in this context means unusual and/or increasing volcanic activity which could presage a volcanic eruption.

4.12.3.2 When air-ground data link is used, special air-reports shall contain the following elements:

message type designator
aircraft identification

Data block 1:

latitude
longitude
pressure-altitude
time

Data block 2:

wind direction
wind speed
wind quality flag
air temperature
turbulence (if available)
humidity (if available)

Data block 3:

Condition prompting the issuance of the special air-report; to be selected from the list a) to k) presented under 4.12.3.1.

4.12.3.3 When voice communications are used, special air-reports shall contain the following elements:

Message type designator

Section 1.— Position information

1) aircraft identification

- 2) position
- 3) time
- 4) flight level or altitude

Section 3.— Meteorological information

- 5) Condition prompting the issuance of the special air report, to be selected from the list a) to k) presented under 4.12.3.1.

4.12.4 Compilation and transmission of air-reports by voice communications

4.12.4.1 Forms based on the model AIREP SPECIAL form at **Appendix 1** shall be provided for the use of flight crews in compiling the reports. The detailed instructions for reporting, as given at **Appendix 1**, shall be complied with.

4.12.4.2 The detailed instructions, including the formats of messages and the phraseologies given at **Appendix 1**, shall be used by flight crews when transmitting air-reports and by air traffic services units when retransmitting such reports.

Note.— Increasing use of air-reports in automated systems makes it essential that the elements of such reports be transmitted in the order and form prescribed.

4.12.5 Recording of special air-reports of volcanic activity

4.12.5.1 Special air-reports containing observations of volcanic activity shall be recorded on the special air-report of volcanic activity form. Forms based on the model form for special air-reports of volcanic activity at **Appendix 1** shall be provided for flight crews operating on routes which could be affected by volcanic ash clouds.

Note.— The recording and reporting instructions may conveniently be printed on the back of the special air-report of volcanic activity form.

4.12.6 Forwarding of meteorological information

4.12.6.1 When receiving ADS-C reports which contain a meteorological information block, air traffic services units shall relay the basic ADS-C and meteorological information blocks without delay to the world area forecast centres (WAFCs).

Note.— Specifications concerning the format to be used in the relay of meteorological information to the WAFCs are contained in the Manual on Aeronautical Meteorological Practice (Doc 8896).

4.12.6.2 When receiving special air-reports by data link communications, air traffic services units shall forward them without delay to their associated meteorological watch office and the WAFCs.

4.12.6.3 When receiving special air-reports by voice communications, air traffic services units shall forward them without delay to their associated meteorological watch offices.

4.13 PRESENTATION AND UPDATING OF FLIGHT PLAN AND CONTROL DATA

4.13.1 General

4.13.1.1 ATC units shall establish provisions and procedures for the presentation to controllers, and subsequent updating, of flight plan and control data for all flights being provided with a service by an ATS unit. Provision shall also be made for the presentation of any other information required or desirable for the provision of ATS.

4.13.2 Information and data to be presented

4.13.2.1 Sufficient information and data shall be presented in such a manner as to enable the controller to have a complete representation of the current air traffic situation within the controller's area of responsibility and, when relevant, movements on the manoeuvring area of aerodromes. The presentation shall be updated in accordance with the progress of aircraft, in order to facilitate the timely detection and resolution of conflicts as well as to facilitate and provide a record of coordination with adjacent ATS units and control sectors.

4.13.2.2 An appropriate representation of the airspace configuration, including significant points and information related to such points, shall be provided. Data to be presented shall include relevant information from flight plans and position reports as well as clearance and coordination data. The information display may be generated and updated automatically, or the data may be entered and updated by authorized personnel.

4.13.2.3 Requirements regarding other information to be displayed, or to be available for display, shall be specified by the appropriate authority.

4.13.3 Presentation of information and data

4.13.3.1 The required flight plan and control data may be presented through the use of paper flight progress strips or electronic flight progress strips, by other electronic presentation forms or by a combination of presentation methods.

4.13.3.2 The method(s) of presenting information and data shall be in accordance with Human Factors principles. All data, including data related to individual aircraft, shall be presented in a manner minimizing the potential for misinterpretation or misunderstanding.

4.13.3.3 Means and methods for manually entering data in ATC automation systems shall be in accordance with Human Factors principles.

4.13.3.4 When flight progress strips (FPS) are used, there should be at least one individual FPS for each flight. The number of FPS for individual flights shall be sufficient to meet the requirements of the ATS unit concerned. Procedures for annotating data and provisions specifying the types of data to be entered on FPS, including the use of symbols, shall be specified by the ATS units.

Note.— Guidance material on the use of paper FPS is contained in the Air Traffic Services Planning Manual (Doc 9426).

4.13.3.5 Data generated automatically shall be presented to the controller in a timely manner. The presentation of information and data for individual flights shall continue until such time as the data is no longer required for the purpose of providing control, including conflict detection and the coordination of flights, or until terminated by the controller.

4.14 FAILURE OR IRREGULARITY OF SYSTEMS AND EQUIPMENT

4.14.1 ATC units shall immediately report in accordance with local instructions any failure or irregularity of communication, navigation and surveillance systems or any other safety significant systems or equipment which could adversely affect the safety or efficiency of flight operations and/or the provision of air traffic control service.

4.15 DATA LINK COMMUNICATIONS INITIATION PROCEDURES

4.15.1 Before entering an airspace where data link applications are required by the ATS unit, data link communications shall be initiated between the aircraft and the ATS unit in order to register the aircraft and, when necessary, allow the start of a data link application. This shall be initiated by the aircraft, either automatically or by the pilot, or by the ATS unit on address forwarding.

4.15.1.1 The DLIC address associated with an ATS unit shall be published in Aeronautical Information Publications.

4.15.2 Aircraft initiation

4.15.2.1 Whenever the pilot or the aircraft initiates data link communication procedures, an initiation message shall be sent. Except when the initiation message is corrupted, it shall not be rejected by the ATS unit.

4.15.3 ATS unit forwarding

4.15.3.1 Where the ground system initially contacted by the aircraft is able to pass the necessary aircraft address information to another ATS unit, it shall pass the aircraft updated ground addressing information for data link applications previously coordinated in sufficient time to permit the establishment of data link communications.

4.15.4 Failure

4.15.4.1 In the case of an initiation failure, the originator of the data link initiation process shall be informed.

4.16 REQUIREMENTS FOR COMMUNICATIONS

4.16.1 Communications are a vital part of the provision of air traffic services (ATS) and their timely and dependable availability have a most significant bearing on the quality of the service provided by ATS. Radiotelephony and/or data link shall be used in air-ground communications for air traffic services purposes. The basic provisions regarding requirements for communications by different air traffic services and ATS units are contained in ICAO Annex 11, Chapter 6 for the ANSP's compliance. Information on facility requirements can be found in Appendix 8.

4.16.2 Recording and retention of data for investigative purposes

4.16.2.1 Surveillance data from primary and secondary radar equipment or other systems (e.g. ADS-B, ADS-C), used as an aid to air traffic services, shall be automatically recorded for use in accident and incident investigations, search and rescue, air traffic control and surveillance systems evaluation and training. Automatic recordings shall be retained for a period of at least thirty days. When the recordings are pertinent to accident and incident investigations, they shall be retained for longer periods until it is evident that they will no longer be required. Paper FPS shall be retained for a period of at least 30 days. Electronic flight progress and coordination data shall be recorded and retained for at least the same period of time (see Appendix 9).

4.17 TIME IN AIR TRAFFIC SERVICES

4.17.1 Air traffic services units shall use Coordinated Universal Time (UTC) and shall express the time in hours and minutes and, when required, seconds of the 24-hour day beginning at midnight.

4.17.2 Air traffic services units shall be equipped with clocks indicating the time in hours, minutes and seconds, clearly visible from each operating position in the unit concerned.

4.17.3 Air traffic services unit clocks and other time-recording devices shall be checked as necessary to ensure correct time to within plus or minus 30 seconds of UTC. Wherever data link communications are utilized by an air traffic services unit, clocks and other time-recording devices shall be checked as necessary to ensure correct time to within 1 second of UTC.

4.17.4 The correct time shall be obtained from a standard time station or, if not possible, from another unit which has obtained the correct time from such station.

4.17.5 Aerodrome control towers shall, prior to an aircraft taxiing for take-off, provide the pilot with the correct time, unless arrangements have been made for the pilot to obtain it from other sources. Air traffic services units shall, in addition, provide

aircraft with the correct time on request. Time checks shall be given to the nearest half minute.

4.18 IDENTIFICATION AND DELINEATION OF PROHIBITED, RESTRICTED AND DANGER AREAS

4.18.1 Each prohibited area, restricted area, or danger area established by the air navigation service provider shall, upon initial establishment, be given an identification and full details shall be promulgated.

Note. – See Annex 15, Appendix 1, ENR 5.1.

4.18.2 The identification so assigned shall be used to identify the area in all subsequent notifications pertaining to the area.

4.18.3 The identification shall be composed of a group of letters and figures as follows:

- a) WS;
- b) A letter P for prohibited area, R for restricted area and D for danger area as appropriate; and
- c) A number, unduplicated within Singapore.

4.18.4 To avoid confusion, identification numbers shall not be reused for a period of at least one year after cancellation of the area to which they refer.

4.18.5 When a prohibited, restricted or danger area is established, the area should be as small as practicable and be contained within simple geometric limits, so as to permit ease of reference by all concerned.

CHAPTER 5

SEPARATION METHODS AND MINIMA

5.1 INTRODUCTION

Note 1: — With the exceptions stated below, Chapter 5 contains procedures and procedural separation minima for use in the separation of aircraft in the en route phase as well as aircraft in the arrival and departure phases of flight.

Note 2: — Procedures and separation minima applicable to approaches to parallel runways are contained in Chapter 6. Procedures and separation minima applicable in the provision of aerodrome control service are contained in Chapter 7 and procedures and separation minima applicable to the use of ATS surveillance systems are contained in Chapter 8.

Note 3: — Attention is drawn to the use of strategic lateral offset procedures (SLOP) described in Chapter 16, 16.5.

5.2 PROVISIONS FOR THE SEPARATION OF CONTROLLED TRAFFIC

5.2.1 General

5.2.1.1 Vertical or horizontal separation shall be provided:

- a) between all flights in Class A and B airspaces;
- b) between IFR flights in Class C, D and E airspaces;
- c) between IFR flights and VFR flights in Class C airspace;
- d) between IFR flights and special VFR flights; and
- e) between special VFR flights, when so prescribed by the ANSP

5.2.1.2 No clearance shall be given to execute any manoeuvre that would reduce the spacing between two aircraft to less than the separation minimum applicable in the circumstances.

5.2.1.3 Larger separations than the specified minima should be applied whenever exceptional circumstances such as unlawful interference or navigational difficulties call

for extra precautions. This should be done with due regard to all relevant factors so as to avoid impeding the flow of air traffic by the application of excessive separations.

Note — Unlawful interference with an aircraft constitutes a case of exceptional circumstances which might require the application of separations larger than the specified minima, between the aircraft being subjected to unlawful interference and other aircraft.

5.2.1.4 Where the type of separation or minimum used to separate two aircraft cannot be maintained, another type of separation or another minimum shall be established prior to the time when the current separation minimum would be infringed.

5.2.2 Performance-based navigation (PBN) operations

5.2.2.1 In implementing performance-based navigation, the ANSP must:

- a) establish and publish in the AIP navigation specifications that are
 - i. based on regional air navigation agreements, when applicable; and
 - ii. appropriate to the level of communications, navigation and air traffic services provided in the airspace concerned; and
- b) take into consideration the guidance on PBN in ICAO Doc 9613 (Performance-Based Navigation Manual).

5.2.3 Performance-based communication (PBC) operations

5.2.3.1 In implementing performance-based communication (PBC), the ANSP must:

- a) establish and publish in the AIP the required communication performance (RCP) specifications that are:
 - i. based on regional air navigation agreements, when applicable; and
 - ii. appropriate to the air traffic services provided; and
- b) take into consideration the guidance on performance-based communication and surveillance (PBCS) in ICAO Doc 9869 (PBCS Manual).

5.2.4 Performance-based surveillance (PBS) operations

5.2.4.1 In implementing performance-based surveillance (PBS), the ANSP must:

- a) establish and publish in the AIP the required surveillance performance (RSP) specifications that are
 - i. based on regional air navigation agreements, when applicable; and
 - ii. appropriate to the air traffic services provided; and
- b) take into consideration the guidance on performance-based communication and surveillance (PBCS) in ICAO Doc 9869 (PBCS Manual); and

- c) ensure that it is equipped with systems capable of performance consistent with the prescribed RSP specifications.

5.2.5 Degraded aircraft performance

5.2.5.1 Whenever, as a result of failure or degradation of navigation, communications, altimetry, flight control or other systems, aircraft performance is degraded below the level required for the airspace in which it is operating, the flight crew shall advise the ATC unit concerned without delay. Where the failure or degradation affects the separation minimum currently being employed, the controller shall take action to establish another appropriate type of separation or separation minimum.

5.3 VERTICAL SEPARATION

5.3.1 Vertical separation application

5.3.1.1 Vertical separation is obtained by requiring aircraft using prescribed altimeter setting procedures to operate at different levels expressed in terms of flight levels or altitudes in accordance with the provisions in Chapter 4, Section 4.10. The ANSP shall establish requirements for carriage and operation of pressure-altitude reporting transponders within its airspace so as to improve the effectiveness of air traffic services as well as airborne collision avoidance systems.

5.3.2 Vertical separation minimum

5.3.2.1 The vertical separation minimum (VSM) shall be:

- a) a nominal 1 000 ft below FL 290 and a nominal 2 000 ft at or above this level, except as provided for in b) below; and
- b) within designated airspace, where a nominal 1 000 ft below FL 410 or a higher level is so prescribed for use under specified conditions, and a nominal 2 000 ft at or above this level.

Note.— Guidance material relating to vertical separation is contained in the Manual on Implementation of a 1 000 ft Vertical Separation Minimum Between FL 290 and FL 410 Inclusive (Doc 9574).

5.3.3 Assignment of cruising levels for controlled flights

5.3.3.1 An ATC unit shall normally authorize only one level for an aircraft beyond its control area, i.e. that level at which the aircraft will enter the next control area whether contiguous or not. It is the responsibility of the accepting ATC unit to issue clearance for further climb as appropriate. When relevant, aircraft will be advised to request en route any cruising level changes desired.

5.3.3.2 If it is necessary to change the cruising level of an aircraft operating along an established ATS route extending partly within and partly outside controlled airspace and where the respective series of cruising levels are not identical, the change shall, whenever possible, be effected within controlled airspace.

5.3.3.3 When an aircraft has been cleared into a control area at a cruising level which is below the established minimum cruising level for a subsequent portion of the route, the ATC unit responsible for the area should issue a revised clearance to the aircraft even though the pilot has not requested the necessary cruising level change.

5.3.3.4 An aircraft may be cleared to change cruising level at a specified time, place or rate.

Note.— See Chapter 5, 5.3.4.1.1 concerning procedures for vertical speed control.

5.3.3.5 In so far as practicable, cruising levels of aircraft flying to the same destination shall be assigned in a manner that will be correct for an approach sequence at destination.

5.3.3.6 An aircraft at a cruising level shall normally have priority over other aircraft requesting that cruising level. When two or more aircraft are at the same cruising level, the preceding aircraft shall normally have priority.

5.3.3.7 The cruising levels to be assigned to controlled flights shall be selected from those allocated to IFR flights in:

- a) the tables of cruising levels in *Appendix 3* of ICAO Annex 2; or
- b) a modified table of cruising levels, when so prescribed in accordance with *Appendix 3* of ICAO Annex 2 for flights above flight level 410; except that the correlation of levels to track as prescribed therein shall not apply whenever otherwise indicated in air traffic control clearances or specified in the AIP Singapore.

5.3.4 Vertical separation during climb or descent

5.3.4.1 An aircraft may be cleared to a level previously occupied by another aircraft after the latter has reported vacating it, except when:

- a) severe turbulence is known to exist; or
- b) the difference in aircraft performance is such that less than the applicable separation minimum may result; in which case such clearance shall be withheld until the aircraft vacating the level has reported at or passing another level separated by the required minimum.

5.3.4.1.1 When the aircraft concerned are entering or established in the same holding pattern, consideration shall be given to aircraft descending at markedly different rates and, if necessary, additional measures such as specifying a maximum descent rate for

the higher aircraft and a minimum descent rate for the lower aircraft, should be applied to ensure that the required separation is maintained.

5.3.4.2 Pilots in direct communication with each other may, with their concurrence, be cleared to maintain a specified vertical separation between their aircraft during ascent or descent.

5.4 HORIZONTAL SEPARATION

Note 1.— Nothing in the provisions detailed in Sections 5.4.1 and 5.4.2 hereunder precludes the ATC units from establishing:

- a) other minima for use in circumstances not prescribed; or
- b) additional conditions to those prescribed for the use of a given minimum; provided that the level of safety inherent in the provisions detailed in Sections 5.4.1 and 5.4.2 hereunder is at all times assured.

Note 2.— Details on track spacing between parallel routes are provided in ICAO Annex 11, Attachments A and B.

Note 3.— Attention is drawn to the following guidance material:

- a) Air Traffic Services Planning Manual (Doc 9426);
- b) Manual on Airspace Planning Methodology for the Determination of Separation Minima (Doc 9689); and
- c) Performance-based Navigation (PBN) Manual (Doc 9613).

Note 4.— Provisions concerning reductions in separation minima are contained in Section 5.11 and in Chapter 2, ATS safety management.

5.4.1 Lateral separation

5.4.1.1 LATERAL SEPARATION APPLICATION

5.4.1.1.1 Lateral separation shall be applied so that the distance between those portions of the intended routes for which the aircraft are to be laterally separated is never less than an established distance to account for navigational inaccuracies plus a specified buffer. This buffer shall be determined by the ANSP and included in the lateral separation minima as an integral part thereof.

Note.— In the minima specified in 5.4.1.2 an appropriate buffer has already been included.

5.4.1.1.2 Lateral separation of aircraft is obtained by requiring operation on different routes or in different geographical locations as determined by visual observation, by the use of navigation aids or by the use of area navigation (RNAV) equipment.

5.4.1.1.3 When information is received indicating navigation equipment failure or deterioration below the navigation performance requirements, ATC shall then, as required, apply alternative separation methods or minima.

5.4.1.2 LATERAL SEPARATION CRITERIA AND MINIMA

5.4.1.2.1 Means by which lateral separation may be applied include the following:

5.4.1.2.1.1 *By reference to the same or different geographic locations.* By position reports which positively indicate the aircraft are over different geographic locations as determined visually or by reference to a navigation aid (see Figure 5-1).

5.4.1.2.1.2 *By use of the same navigation aid or method.* By requiring aircraft to fly on specified tracks which are separated by a minimum amount appropriate to the navigation aid or method employed. Lateral separation between two aircraft exists when:

a) **VOR:** both aircraft are established on radials diverging by at least 15 degrees and at least one aircraft is at a distance of 15 NM or more from the facility (see Figure 5-2);

b) **NDB:** both aircraft are established on tracks to or from the NDB which are diverging by at least 30 degrees and at least one aircraft at a distance of 15 NM or more from the facility (see Figure 5-3);

c) **dead reckoning (DR):** both aircraft are established on tracks diverging by at least 45 degrees and at least one aircraft is at a distance of 15 NM or more from the point of intersection of the tracks, this point being determined either visually or by reference to a navigation aid and both aircraft are established outbound from the intersection (see Figure 5-4); or

d) **RNAV operations:** both aircraft are established on tracks which diverge by at least 15 degrees and the protected airspace associated with the track of one aircraft does not overlap with the protected airspace associated with the track of the other aircraft. This is determined by applying the angular difference between two tracks and the appropriate protected airspace value. The derived value is expressed as a distance from the intersection of the two tracks at which lateral separation exists.

5.4.1.2.1.2.1 When aircraft are operating on tracks which are separated by considerably more than the foregoing minimum figures, the distance at which lateral separation is achieved may be reduced.

5.4.1.2.1.3 *By use of different navigation aids or methods.* Lateral separation between aircraft using different navigation aids, or when one aircraft is using RNAV equipment, shall be established by ensuring that the derived protected airspaces for the navigation aid(s) or RNP do not overlap.

5.4.1.2.1.4 *Lateral separation of aircraft on published adjacent instrument flight procedures for arrivals and departures*

5.4.1.2.1.4.1 Lateral separation of departing and/or arriving aircraft, using instrument flight procedures, will exist:

(a) Where the distance between RNAV 1, Basic RNP 1, RNP APCH and/or RNP AR APCH tracks is not less than 7 NM; or

- (b) Where the protected areas of tracks designed using obstacle clearance criteria do not overlap and provided operational error is considered.

Note 1.— The 7 NM value was determined by collision risk analysis using multiple navigation specifications. Information on this analysis is contained in Circular 324, Guidelines for lateral separation of arriving and departing aircraft on published adjacent instrument flight procedures.

Note 2.— Circular 324 also contains information on separation of arrival and departure tracks using non-overlapping protected areas based on obstacle clearance criteria, as provided for in the Procedures for Air Navigation Services – Aircraft Operations, Volume II – Construction of Visual and Instrument Flight Procedures (PANS-OPS, Doc 8168).

Note 3.— Provisions concerning reductions in separation minima are contained in Chapter 2, ATS Safety Management and Chapter 5, Separation Methods and Minima, Section 5.11.

Note 4.— Guidance concerning the navigation specifications is contained in the Performance-based Navigation (PBN) Manual (Doc 9613).

5.4.1.2.1.5 RNAV operations where RNP is specified on parallel tracks or ATS routes. Within designated airspace or on designated routes, where RNP is specified, lateral separation between RNAV-equipped aircraft may be obtained by requiring aircraft to be established on the centre lines of parallel tracks or ATS routes spaced at a distance which ensures that the protected airspace of the tracks or ATS routes does not overlap.

Note.— The spacing between parallel tracks or between parallel ATS route centre lines for which an RNP type is required will be dependent upon the relevant RNP type specified. Guidance material related to the spacing between tracks or ATS routes based on RNP type is contained in ICAO Annex 11, Attachment B.

5.4.1.2.1.6 Lateral separation of aircraft on parallel or non-intersecting tracks or ATS routes. Within designated airspace or on designated routes, lateral separation between aircraft operating on parallel or non-intersecting tracks or ATS routes shall be established in accordance with the following:

- a) for a minimum spacing between tracks of 50 NM a navigational performance of RNAV 10 (RNP 10) or RNP 4 shall be prescribed; and
- b) for a minimum spacing between tracks of 30 NM a navigational performance of RNP 4 shall be prescribed.

Note 1.— Guidance material for the implementation of the navigation capability supporting 50 NM and 30 NM lateral separation is contained in the Performance-based Navigation (PBN) Manual (Doc 9613).

Note 2.— Guidance material for implementation of communication capability supporting 50 NM and 30 NM lateral separation is contained in the Manual on Required Communication Performance (RCP) (Doc 9869). Information regarding RCP allocations for these capabilities is contained in RTCA DO-306/EUROCAE ED-122 Safety and Performance Standard for Air Traffic Data Link Services in Oceanic and Remote Airspace (Oceanic SPR Standard).

Note 3.— Existing implementations of 30 NM lateral separation minimum require a communication capability of direct controller-pilot voice communications or CPDLC and a surveillance capability by an ADS-C system in which a periodic contract and waypoint change and lateral deviation event contracts are applied.

5.4.1.2.1.7 ***RNAV operations (where RNP is specified) on intersecting tracks or ATS routes.*** The use of this separation is limited to intersecting tracks that converge to or diverge from a common point at angles between 15 and 135 degrees.

5.4.1.2.1.7.1 For intersecting tracks, the entry points to and the exit points from the area in which lateral distance between the tracks is less than the required minimum are termed lateral separation points. The area bound by the lateral separation points is termed the area of conflict (see Figure 5-5).

5.4.1.2.1.7.2 The distance of the lateral separation points from the track intersection shall be determined by collision risk analysis and will depend on complex factors such as the navigation accuracy of the aircraft, traffic density, and occupancy.

Note.— Information on the establishment of lateral separation points and collision risk analyses are contained in the Manual on Airspace Planning Methodology for the Determination of Separation Minima (Doc 9689).

5.4.1.2.1.7.3 Lateral separation exists between two aircraft when at least one of the aircraft is outside the area of conflict.

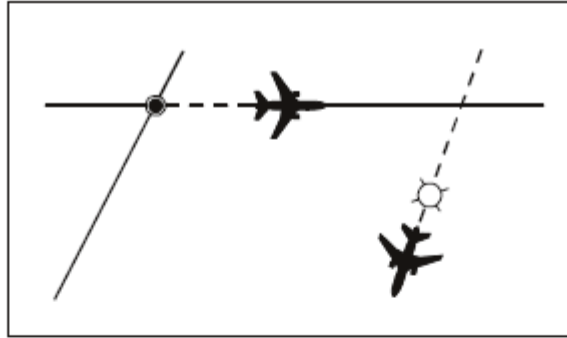

Figure 5-1. Using same or different geographic locations (see 5.4.1.2.1.1)

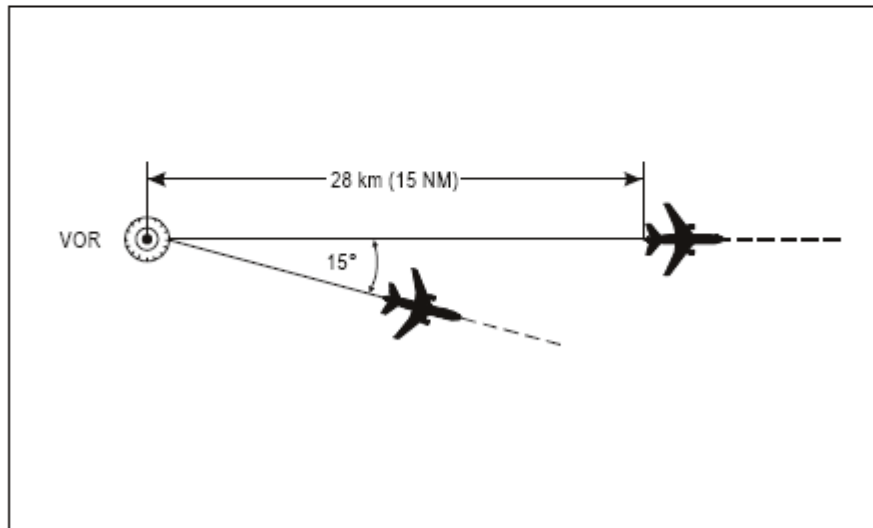

Figure 5-2. Separation using the same VOR (see 5.4.1.2.1.2 a))

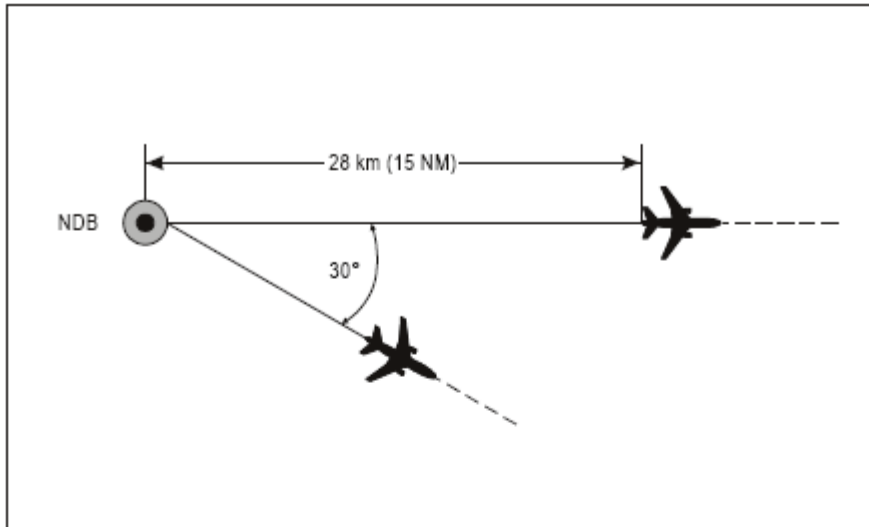

Figure 5-3. Separation using the same NDB (see 5.4.1.2.1.2 b))

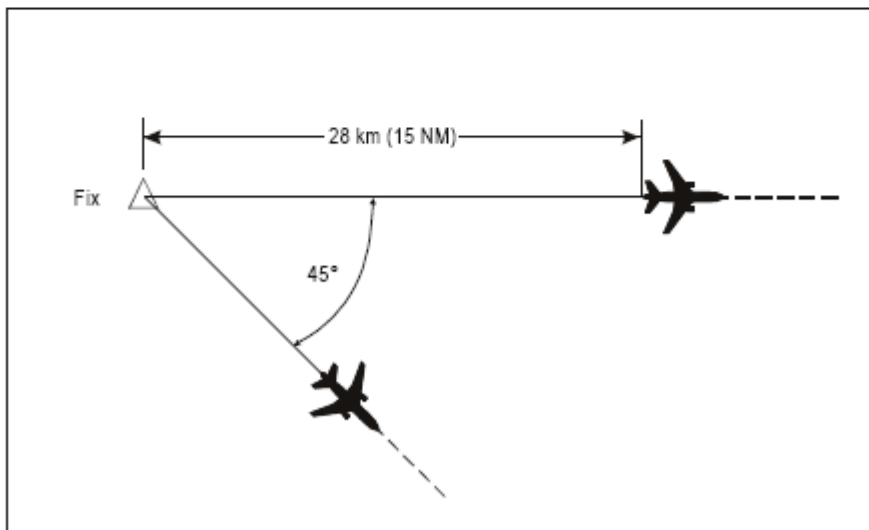

Figure 5-4. Separation using dead reckoning (see 5.4.1.2.1.2 c))

5.4.1.2.1.8 **Transitioning into airspace where a greater lateral separation minimum applies.** Lateral separation will exist when aircraft are established on specified tracks which:

- a) are separated by an appropriate minimum; and
- b) diverge by at least 15 degrees until the applicable lateral separation minimum is established; providing that it is possible to ensure, by means approved by the ANSP, that aircraft have the navigation capability necessary to ensure accurate track guidance.

5.4.2 Longitudinal separation

5.4.2.1 LONGITUDINAL SEPARATION APPLICATION

5.4.2.1.1 Longitudinal separation shall be applied so that the spacing between the estimated positions of the aircraft being separated is never less than a prescribed minimum. Longitudinal separation between aircraft following the same or diverging tracks may be maintained by application of speed control, including the Mach number technique.

Note 1.— Attention is drawn to the guidance material contained in the Air Traffic Services Planning Manual (Doc 9426) regarding the application of the Mach number technique to separation of subsonic aircraft.

Note 2.— The Mach number technique is applied using true Mach number.

5.4.2.1.2 In applying a time- or distance-based longitudinal separation minimum between aircraft following the same track, care shall be exercised to ensure that the separation minimum will not be infringed whenever the following aircraft is maintaining a higher air speed than the preceding aircraft. When aircraft are expected to reach minimum separation, speed control shall be applied to ensure that the required separation minimum is maintained.

5.4.2.1.3 Longitudinal separation may be established by requiring aircraft to depart at a specified time, to arrive over a geographical location at a specified time, or to hold over a geographical location until a specified time.

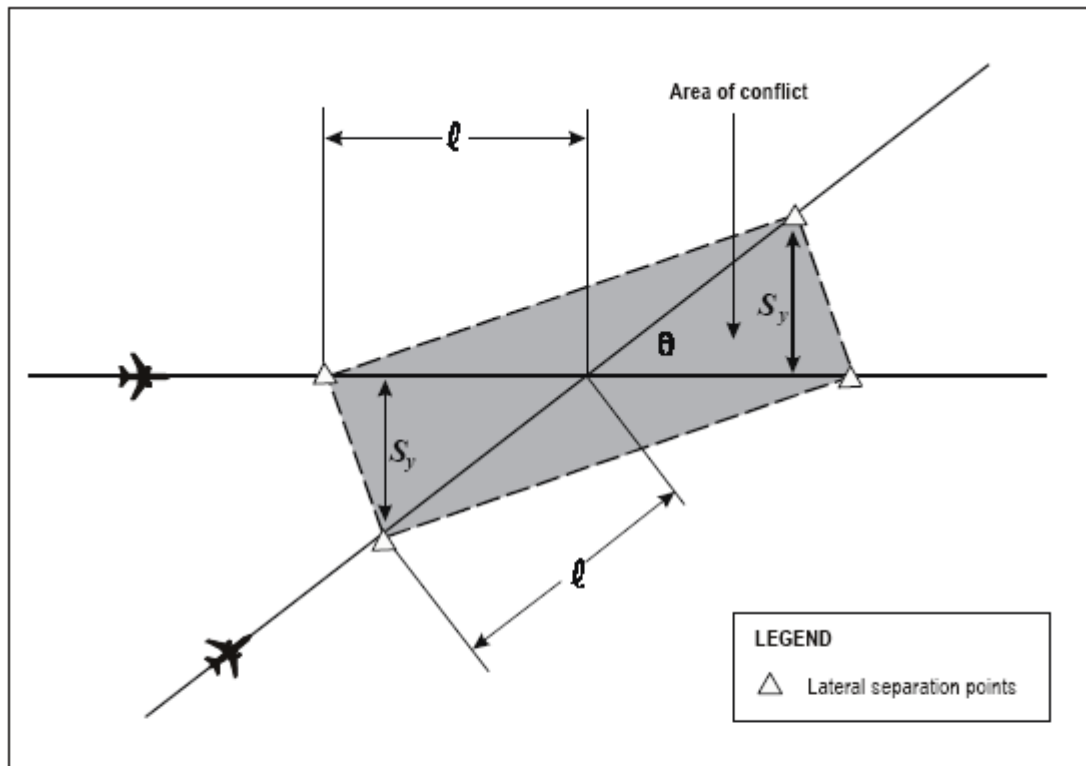

Figure 5-5. Lateral separation points and the area of conflict (see 5.4.1.2.1.5.1)

Note.— The lateral separation points are calculated by the formula: $l = S_y / \sin \theta$

where:

- S_y = the lateral distance between the tracks equal to the lateral separation minimum;
- l = the distance of the lateral separation point from the intersection; and
- θ = the angle between tracks.

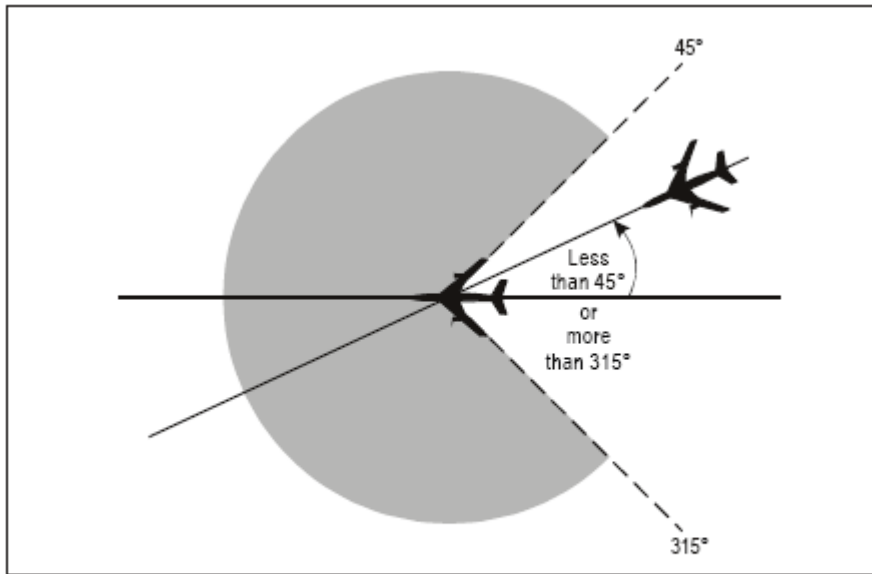

Figure 5-6. Aircraft on same track (see 5.4.2.1.5 a))

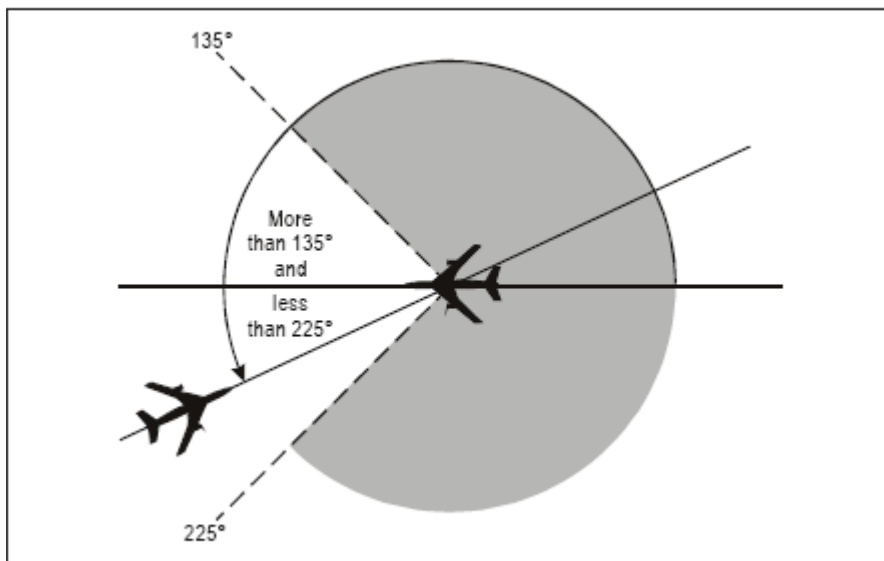

Figure 5-7. Aircraft on reciprocal tracks (see 5.4.2.1.5 b))

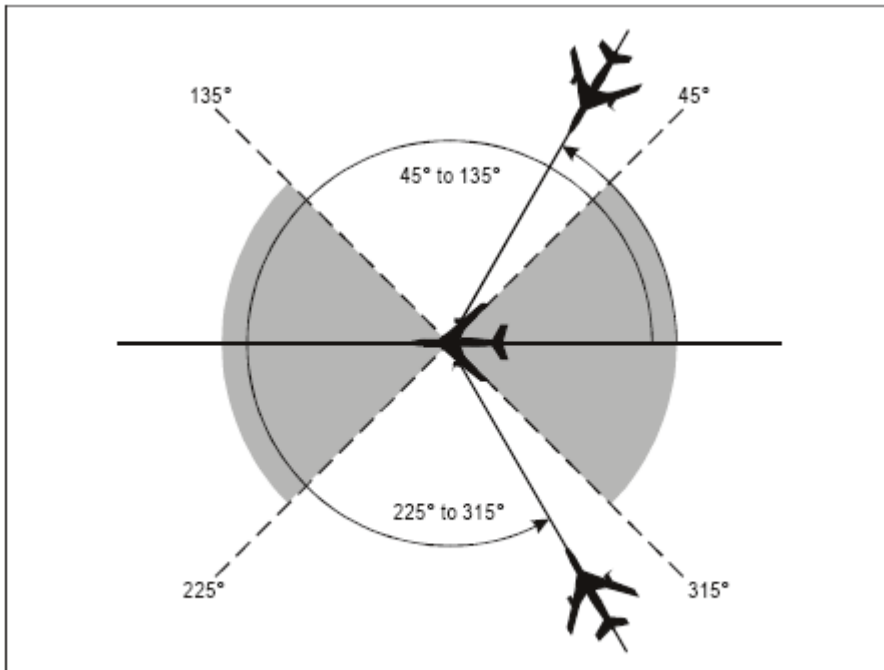

Figure 5-8. Aircraft on crossing tracks (see 5.4.2.1.5 c)

5.4.2.1.4 For the purpose of application of longitudinal separation, the terms *same track*, *reciprocal tracks* and *crossing tracks* shall have the following meanings:

- a) Same track (see Figure 5-6): same direction tracks and intersecting tracks or portions thereof, the angular difference of which is less than 45 degrees or more than 315 degrees, and whose protected airspaces overlap.
- b) Reciprocal tracks (see Figure 5-7): opposite tracks and intersecting tracks or portions thereof, the angular difference of which is more than 135 degrees but less than 225 degrees, and whose protected airspaces overlap.
- c) Crossing tracks (see Figure 5-8): intersecting tracks or portions thereof other than those specified in a) and b) above.

5.4.2.1.5 Time-based separation applied in accordance with 5.4.2.2 and 5.4.2.4 may be based on position information and estimates derived from voice reports, CPDLC or ADS-C.

5.4.2.2 LONGITUDINAL SEPARATION MINIMA BASED ON TIME

5.4.2.2.1 AIRCRAFT MAINTAINING THE SAME LEVEL

5.4.2.2.1.1 Aircraft flying on the same track:

- a) 15 minutes (see Figure 5-9); or

- b) 10 minutes, if navigation aids permit frequent determination of position and speed (see Figure 5-10); or
- c) 5 minutes in the following cases, provided that in each case the preceding aircraft is maintaining a true airspeed of 20 kt or more faster than the succeeding aircraft (see Figure 5-11):
 - 1) between aircraft that have departed from the same aerodrome;
 - 2) between en-route aircraft that have reported over the same exact significant point;
 - 3) between departing and en-route aircraft after the en-route aircraft has reported over a fix that is so located in relation to the departure point as to ensure that five-minute separation can be established at the point the departing aircraft will join the air route; or
- d) 3 minutes in the cases listed under c) provided that in each case the preceding aircraft is maintaining a true airspeed of 40 kt or more faster than the succeeding aircraft (see Figure 5-12).

5.4.2.2.1.2 Aircraft flying on crossing tracks:

- a) 15 minutes at the point of intersection of the tracks (see Figure 5-13); or
- b) 10 minutes if navigation aids permit frequent determination of position and speed (see Figure 5-14).

5.4.2.2.2 AIRCRAFT CLIMBING OR DESCENDING

5.4.2.2.2.1 *Aircraft on the same track.* When an aircraft will pass through the level of another aircraft on the same track, the following minimum longitudinal separation shall be provided:

- a) 15 minutes while vertical separation does not exist (see Figures 5-15A and 5-15B); or
- b) 10 minutes while vertical separation does not exist, provided that such separation is authorized only where ground-based navigation aids or GNSS permit frequent determination of position and speed (see Figures 5-16A and 5-16B); or
- c) 5 minutes while vertical separation does not exist, provided that:
 - a) the level change is commenced within 10 minutes of the time the second aircraft has reported over a common point which must be derived from ground-based navigation aids or by GNSS; and
 - b) When issuing the clearance through third party communication or CPDLC a restriction shall be added to the clearance to ensure that the 10 minute condition is satisfied (see Figures 5-17A and 5-17B).

Note.— To facilitate application of the procedure where a considerable change of level is involved, a descending aircraft may be cleared to some convenient level above the lower aircraft, or a climbing aircraft to some convenient level below the higher aircraft, to permit a further check on the separation that will obtain while vertical separation does not exist.

5.4.2.2.2 Aircraft on crossing tracks:

- a) 15 minutes while vertical separation does not exist (see Figures 5-18A and 5-18B); or
- b) 10 minutes while vertical separation does not exist if navigation aids permit frequent determination of position and speed (see Figures 5-19A and 5-19B).

5.4.2.2.3 *Aircraft on reciprocal tracks.* Where lateral separation is not provided, vertical separation shall be provided for at least ten minutes prior to and after the time the aircraft are estimated to pass, or are estimated to have passed (see Figure 5-20). Provided it has been determined that the aircraft have passed each other, this minimum need not apply.

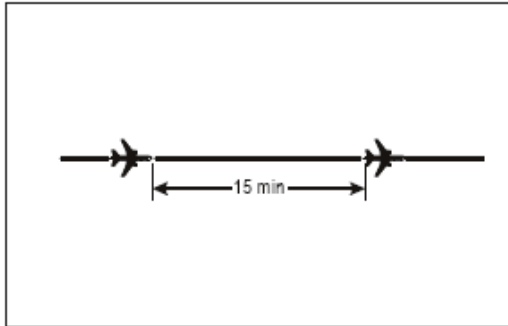

Figure 5-9. Fifteen-minute separation between aircraft on same track and same level (see 5.4.2.2.1.1 a))

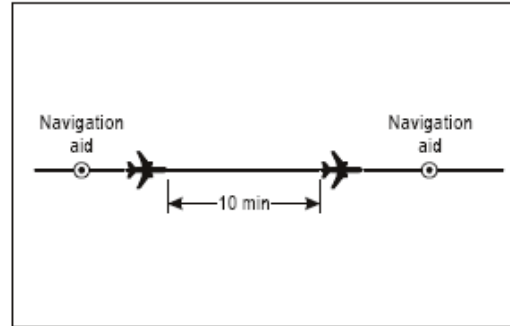

Figure 5-10. Ten-minute separation between aircraft on same track and same level (see 5.4.2.2.1.1 b))

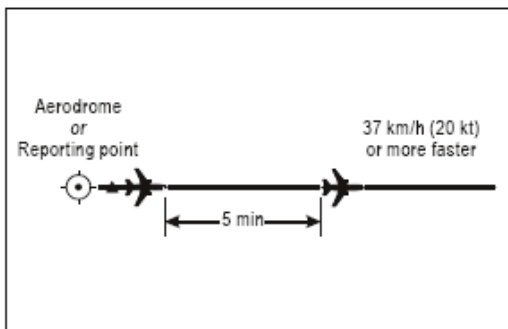

Figure 5-11. Five-minute separation between aircraft on same track and same level (see 5.4.2.2.1.1 c))

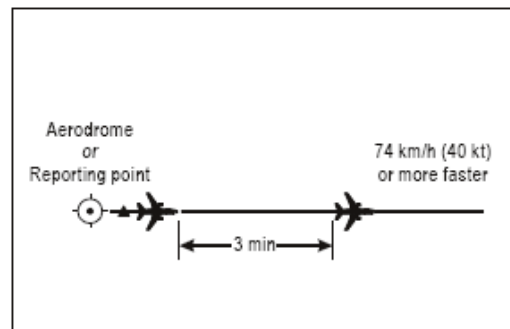

Figure 5-12. Three-minute separation between aircraft on same track and same level (see 5.4.2.2.1.1 d))

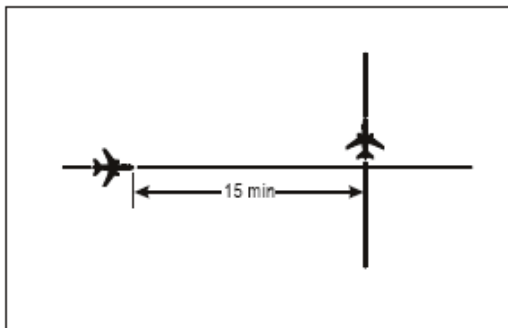

Figure 5-13. Fifteen-minute separation between aircraft on crossing tracks and same level (see 5.4.2.2.1.2 a))

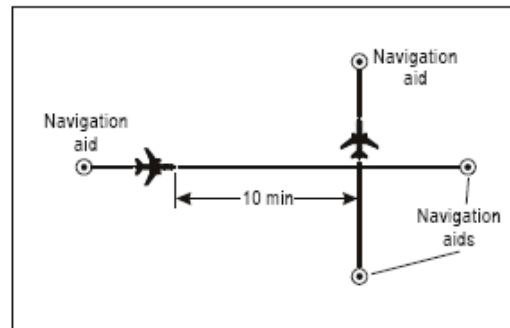

Figure 5-14. Ten-minute separation between aircraft on crossing tracks and same level (see 5.4.2.2.1.2 b))

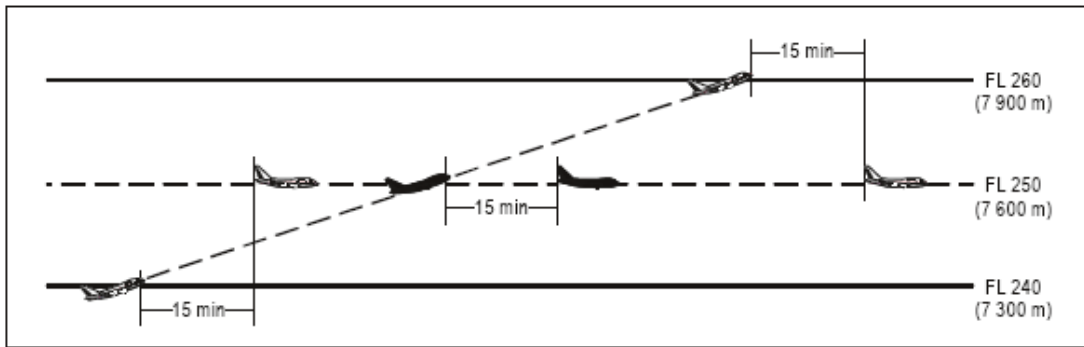

Figure 5-15A. Fifteen-minute separation between aircraft climbing and on same track (see 5.4.2.2.1 a)

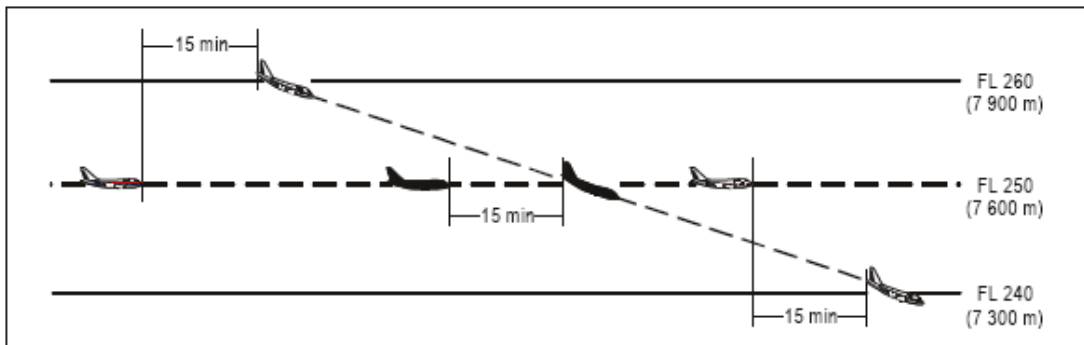

Figure 5-15B. Fifteen-minute separation between aircraft descending and on same track (see 5.4.2.2.1 a)

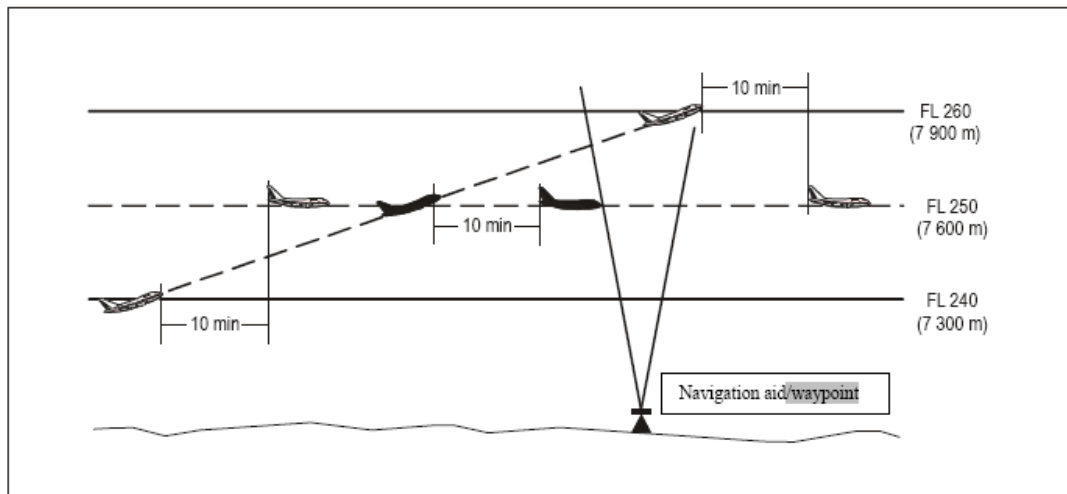

Figure 5-16A. Ten-minute separation between aircraft climbing and on the same track (see 5.4.2.2.2.1 b)

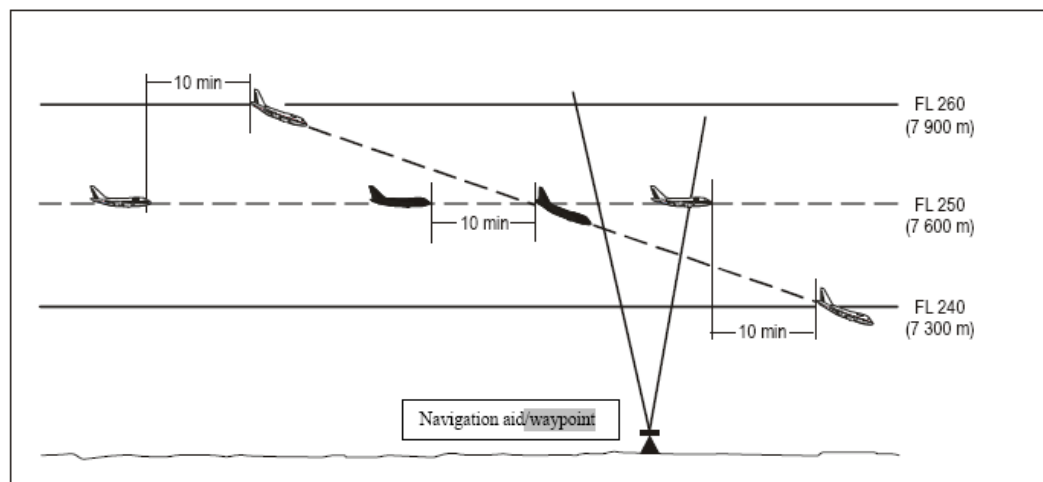

Figure 5-16B. Ten-minute separation between aircraft descending and on same track (see 5.4.2.2.2.1 b)

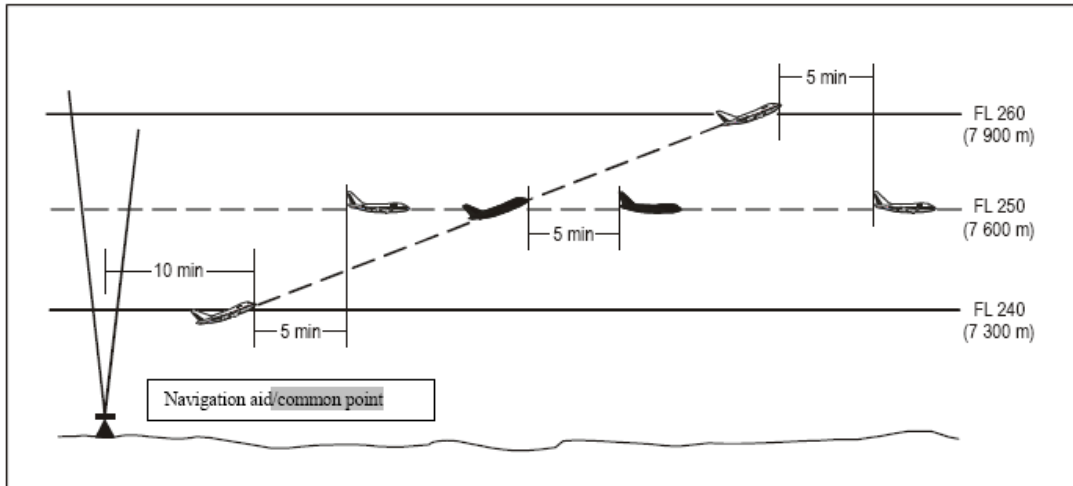

Figure 5-17A. Five-minute separation between aircraft climbing and on same track
(see 5.4.2.2.2.1 c)

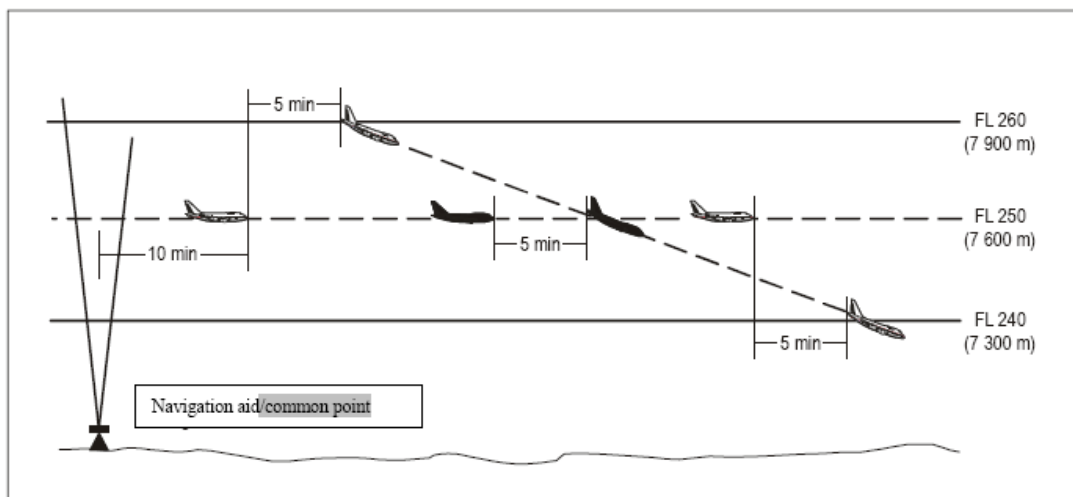

Figure 5-17B. Five-minute separation between aircraft descending and on same track
(see 5.4.2.2.2.1 c)

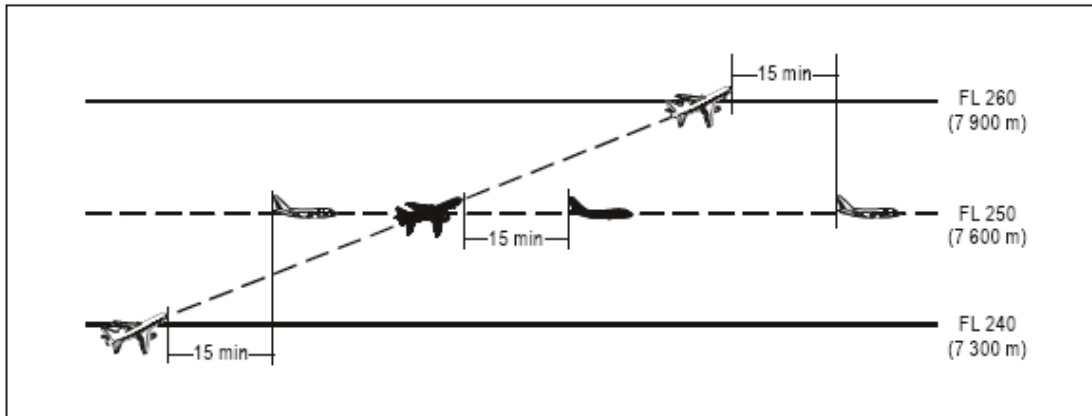

Figure 5-18A. Fifteen-minute separation between aircraft climbing and on crossing tracks (see 5.4.2.2.2.2 a))

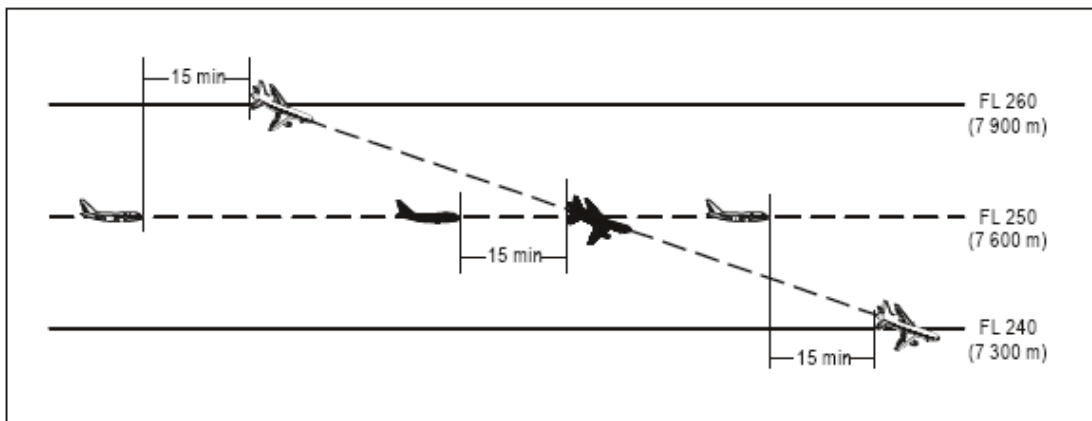

Figure 5-18B. Fifteen-minute separation between aircraft descending and on crossing tracks (see 5.4.2.2.2.2 a))

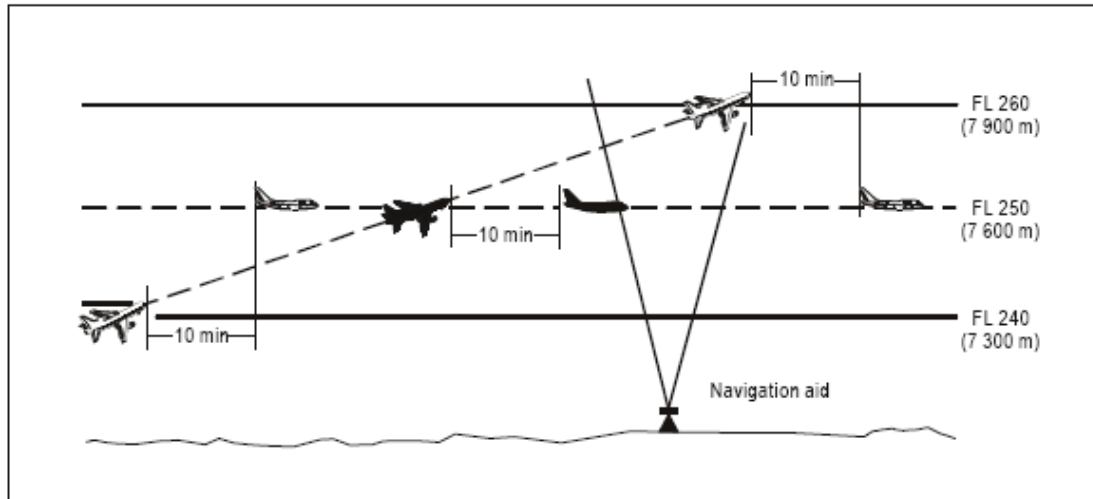

Figure 5-19A. Ten-minute separation between aircraft climbing and on crossing tracks (see 5.4.2.2.2.2 b))

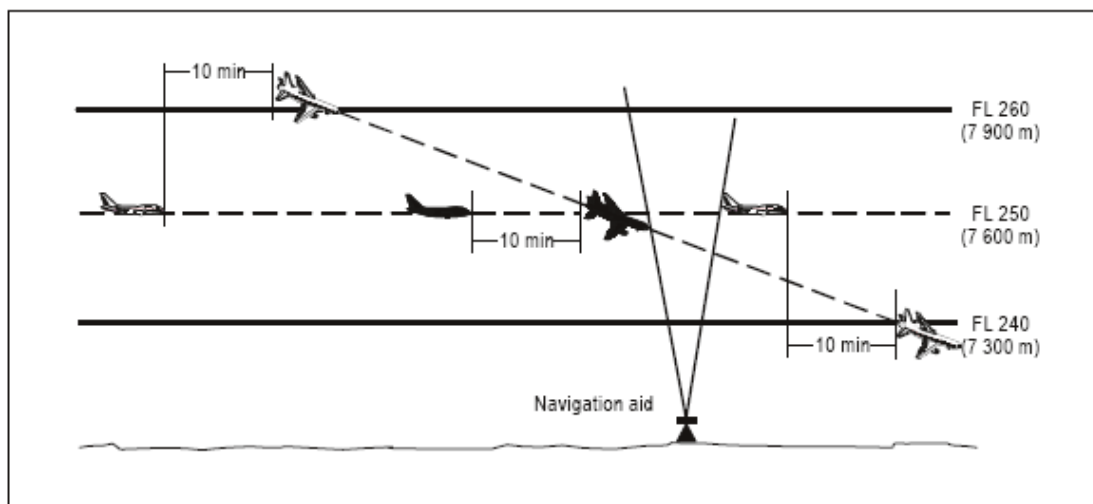

Figure 5-19B. Ten-minute separation between aircraft descending and on crossing tracks (see 5.4.2.2.2.2 b))

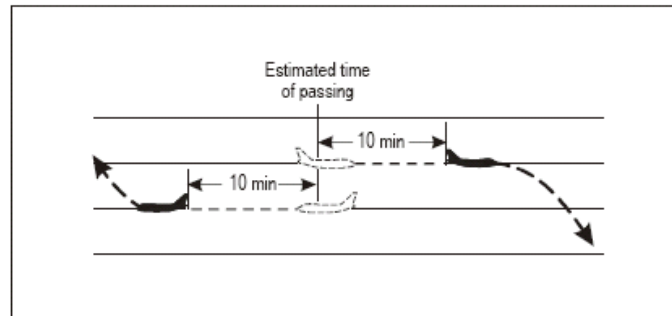

Figure 5-20. Ten-minute separation between aircraft on reciprocal tracks (see 5.4.2.2.3)

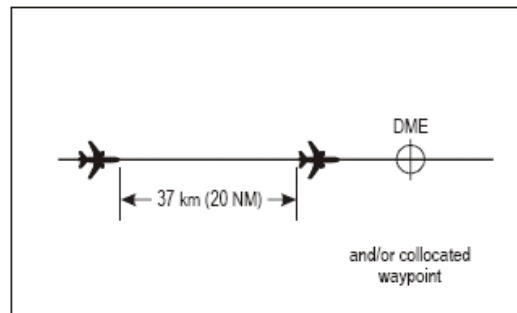

Figure 5-21. 37 km (20 NM) DME or GNSS-based separation between aircraft on same track and same level (see 5.4.2.3.1 a))

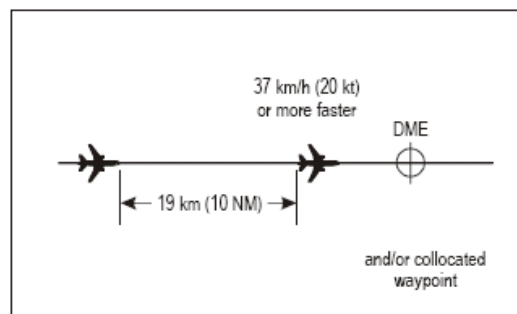

Figure 5-22. 19 km (10 NM) DME or GNSS-based separation between aircraft on same track and same level (see 5.4.2.3.1 b))

5.4.2.3 LONGITUDINAL SEPARATION MINIMA BASED ON DISTANCE USING DISTANCE MEASURING EQUIPMENT (DME) AND/OR GNSS

Note.— Where the term “on track” is used in the provisions relating to the application of longitudinal separation minima using DME and/or GNSS, it means that the aircraft is flying either directly inbound to or directly outbound from the station/waypoint.

5.4.2.3.1 Separation shall be established by maintaining not less than specified distance(s) between aircraft positions as reported by reference to DME in conjunction with other appropriate navigation aids and/or GNSS. This type of separation shall be applied between two aircraft using DME, or two aircraft using GNSS, or one aircraft using DME and one aircraft using GNSS. Direct controller-pilot VHF voice communication shall be maintained while such separation is used.

Note.— For the purpose of applying GNSS-based separation minimum, a distance derived from an integrated navigation system incorporating GNSS input is regarded as equivalent to GNSS distance.

5.4.2.3.2 When applying these separation minima between any aircraft with area navigation capability, controllers shall specifically request GNSS-derived distance.

Note.— Reasons making a pilot unable to provide GNSS distance information may include inadequate on-board equipment, no GNSS input into an integrated navigation system, or a loss of GNSS integrity.

5.4.2.3.3 AIRCRAFT AT THE SAME CRUISING LEVEL

5.4.2.3.3.1 Aircraft on the same track:

a) 20 NM, provided:

1) each aircraft utilizes:

i) the same “on-track” DME stations when both aircraft are utilizing DME; or

ii) an “on-track” DME station and a collocated waypoint when one aircraft is utilizing DME and the other is utilizing GNSS; or

iii) the same waypoint when both aircraft are utilizing GNSS; and

2) separation is checked by obtaining simultaneous DME and/or GNSS readings from the aircraft at frequent intervals to ensure that the minimum will not be infringed (see Figure 5-21);

b) 10 NM, provided:

1) the leading aircraft maintains a true airspeed of 37 km/h (20 kt) or more faster than the succeeding aircraft;

2) each aircraft utilizes:

- i) the same “on-track” DME station when both aircraft are utilizing DME;
or
 - ii) an “on-track” DME station and a collocated waypoint when one aircraft is utilizing DME and the other is utilizing GNSS; or
 - iii) the same waypoint when both aircraft are utilizing GNSS; and
- 3) separation is checked by obtaining simultaneous DME and/or GNSS readings from the aircraft at such intervals as are necessary to ensure that the minimum is established and will not be infringed (see Figure 5-22).

5.4.2.3.3.2 *Aircraft on crossing tracks.* The longitudinal separation prescribed in 5.4.2.3.3.1 shall also apply provided each aircraft reports distance from the DME station and/or collocated waypoint or same waypoint located at the crossing point of the tracks and that the relative angle between the tracks is less than 90 degrees (see Figures 5-23A and 5-23B).

5.4.2.3.4 *Aircraft climbing or descending*

5.4.2.3.4.1 *Aircraft on the same track:* 10 NM while vertical separation does not exist, provided:

- a) each aircraft utilizes:
 - i) the same “on-track” DME station when both aircraft are utilizing DME;
or
 - ii) an “on-track” DME station and a collocated waypoint when one aircraft is utilizing DME and the other is utilizing GNSS; or
 - iii) the same waypoint when both aircraft are utilizing GNSS; and
- b) one aircraft maintains a level while vertical separation does not exist; and
- c) separation is established by obtaining simultaneous DME and/or GNSS readings from the aircraft (see Figures 5-24A and 5-24B).

Note.— To facilitate application of the procedure where a considerable change of level is involved, a descending aircraft may be cleared to some convenient level above the lower aircraft, or a climbing aircraft to some convenient level below the higher aircraft, to permit a further check on the separation that will obtain while vertical separation does not exist.

5.4.2.3.4.2 *Aircraft on reciprocal tracks.* Aircraft utilizing on-track DME and/or collocated waypoint or same waypoint may be cleared to climb or descend through the levels occupied by other aircraft utilizing on-track DME and/or collocated waypoint or same waypoint, provided that it has been positively established that the aircraft have passed each other and are at least 10 NM apart, or such other value as prescribed by the appropriate ATS unit.

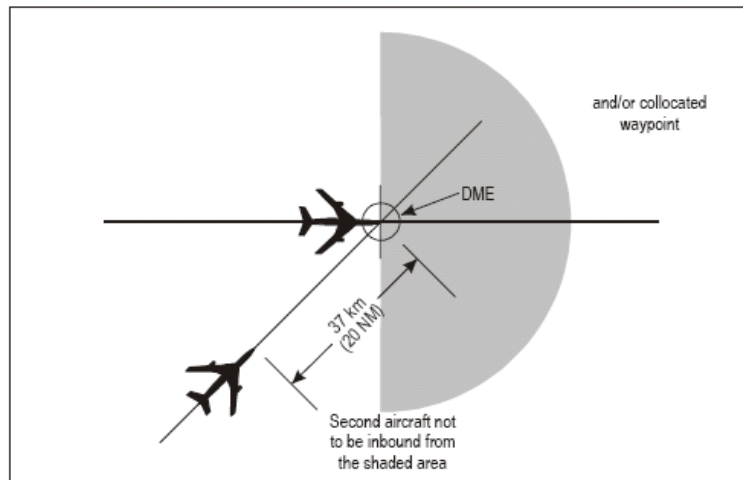

Figure 5-23A. 37 km (20 NM) DME or GNSS-based separation between aircraft on crossing tracks and same level (see 5.4.2.3.3.2)

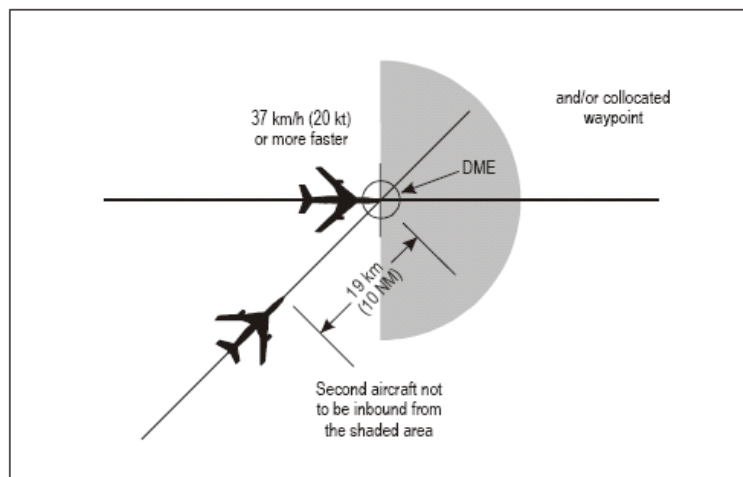

Figure 5-23B. 19 km (10 NM) DME or GNSS-based separation between aircraft on crossing tracks and same level (see 5.4.2.3.3.2)

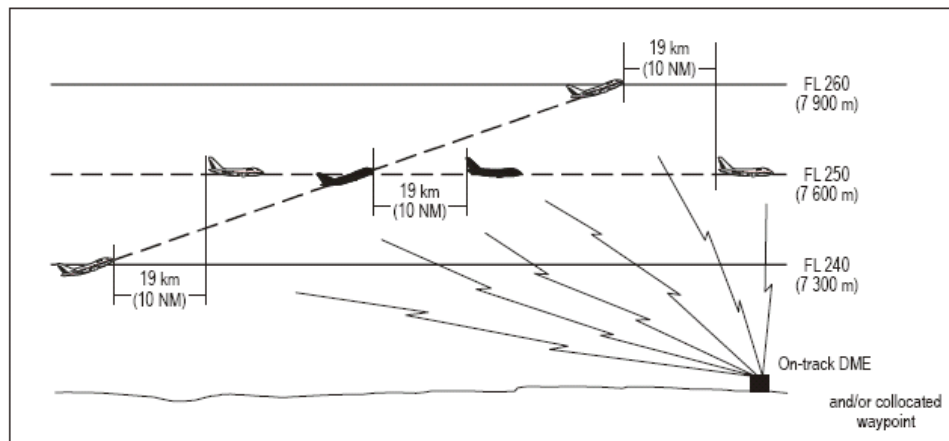

Figure 5-24A. 19 km (10 NM) DME or GNSS-based separation between aircraft climbing and on same track (see 5.4.2.3.4.1 c)

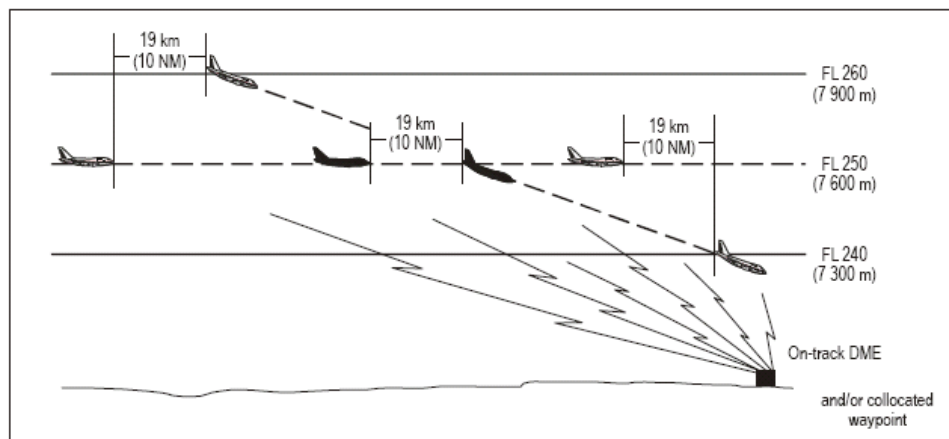

Figure 5-24B. 19 km (10 NM) DME or GNSS-based separation between aircraft descending and on same track (see 5.4.2.3.4.1 c)

5.4.2.4 LONGITUDINAL SEPARATION MINIMA WITH MACH NUMBER TECHNIQUE BASED ON TIME

5.4.2.4.1 Turbojet aircraft shall adhere to the true Mach number approved by ATC and shall request ATC approval before making any changes thereto. If it is essential to make an immediate temporary change in the Mach number (e.g. due to turbulence), ATC shall be notified as soon as possible that such a change has been made.

5.4.2.4.2 If it is not feasible, due to aircraft performance, to maintain the last assigned Mach number during en-route climbs and descents, pilots of aircraft concerned shall advise ATC at the time of the climb/descent request.

5.4.2.4.3 When the Mach number technique is applied and provided that:

a) the aircraft concerned have reported over the same common point and follow the same track or continuously diverging tracks until some other form of separation is provided; or

b) if the aircraft have not reported over the same reporting point and it is possible to ensure, by radar, ADS-B or other means, that the appropriate time interval will exist at the common point from which they either follow the same track or continuously diverging tracks; minimum longitudinal separation between turbojet aircraft on the same track, whether in level, climbing or descending flight shall be:

1) 10 minutes; or

2) between 9 and 5 minutes inclusive, provided that: the preceding aircraft is maintaining a true Mach number greater than the following aircraft in accordance with the following table:

- 9 minutes, if the preceding aircraft is Mach 0.02 faster than the following aircraft;

- 8 minutes, if the preceding aircraft is Mach 0.03 faster than the following aircraft;

- 7 minutes, if the preceding aircraft is Mach 0.04 faster than the following aircraft;

- 6 minutes, if the preceding aircraft is Mach 0.05 faster than the following aircraft;

- 5 minutes, if the preceding aircraft is Mach 0.06 faster than the following aircraft.

5.4.2.4.4 When the 10-minute longitudinal separation minimum with Mach number technique is applied, the preceding aircraft shall maintain a true Mach number equal to or greater than that maintained by the following aircraft.

5.4.2.5 LONGITUDINAL SEPARATION MINIMA WITH MACH NUMBER TECHNIQUE BASED ON DISTANCE USING RNAV

Note.— Guidance material on RNAV operations is contained in the Performance-based Navigation (PBN) Manual (Doc 9613).

5.4.2.5.1 Turbojet aircraft shall adhere to the true Mach number approved by ATC and shall request ATC approval before making any changes thereto. If it is essential to make an immediate temporary change in the Mach number (e.g. due to turbulence), ATC shall be notified as soon as possible that such a change has been made.

5.4.2.5.1.1 If it is not feasible, due to aircraft performance, to maintain the last assigned Mach number during enroute climbs and descents, pilots of aircraft concerned shall advise ATC at the time of the climb/descent request.

5.4.2.5.2 RNAV distance-based separation minima shall not be applied after ATC has received pilot advice indicating navigation equipment deterioration or failure.

5.4.2.5.3 Separation shall be established by maintaining not less than the specified distance between aircraft positions as reported by reference to RNAV equipment. Direct controller-pilot communications should be maintained, while such separation is used. Where high frequency or general purpose extended range very high frequency air-ground communication channels are used for area control service and are worked by air-ground communicators, suitable arrangements shall be made to permit direct controller-pilot communications, or monitoring by the controller of all air-ground communications.

5.4.2.5.3.1 To assist pilots to readily provide the required RNAV distance information, such position reports should, wherever possible, be referenced to a common waypoint ahead of both aircraft.

5.4.2.5.4 RNAV distance-based separation may be applied between RNAV-equipped aircraft when operating on designated RNAV routes or on ATS routes defined by VOR.

5.4.2.5.5 A 80 NM RNAV distance-based separation minimum with Mach number technique may be used on same-direction tracks in lieu of a 10-minute longitudinal separation minimum with Mach number technique, provided:

- a) each aircraft reports its distance to or from the same “on-track” common point;
- b) separation between aircraft at the same level is checked by obtaining simultaneous RNAV distance readings from the aircraft at frequent intervals to ensure that the minimum will not be infringed (see Figure 5-25);

c) separation between aircraft climbing or descending is established by obtaining simultaneous RNAV distance readings from the aircraft (see Figures 5-26A and 5-26B); and

d) in the case of aircraft climbing or descending, one aircraft maintains a level while vertical separation does not exist.

5.4.2.5.6 When the 80 NM longitudinal separation minimum with Mach number technique is applied, the preceding aircraft shall maintain a true Mach number equal to or greater than that maintained by the following aircraft.

Note.— To facilitate application of the procedure where a considerable change of level is involved, a descending aircraft may be cleared to some convenient level above the lower aircraft, or a climbing aircraft to some convenient level below the higher aircraft, to permit a further check on the separation that will obtain while vertical separation does not exist.

5.4.2.5.7 Aircraft on reciprocal tracks.

5.4.2.5.7.1 Aircraft utilizing RNAV may be cleared to climb or descend to or through the levels occupied by other aircraft utilizing RNAV provided it has been positively established by simultaneous RNAV distance readings to or from the same “on-track” common point that the aircraft have passed each other and are at least 80 NM apart (see Figure 5-27).

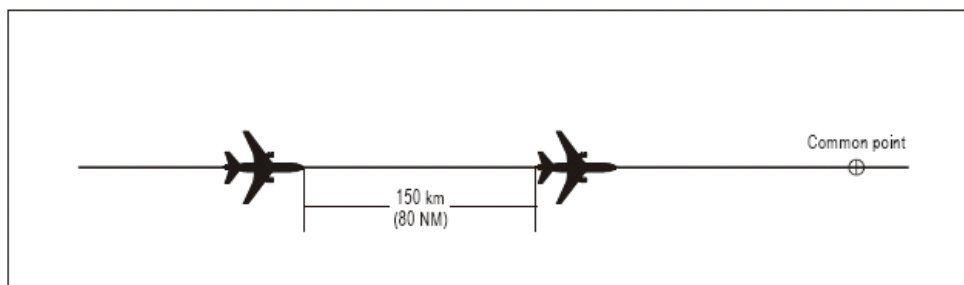

Figure 5-25. 150 km (80 NM) RNAV-based separation between aircraft at the same level (see 5.4.2.5.5 b))

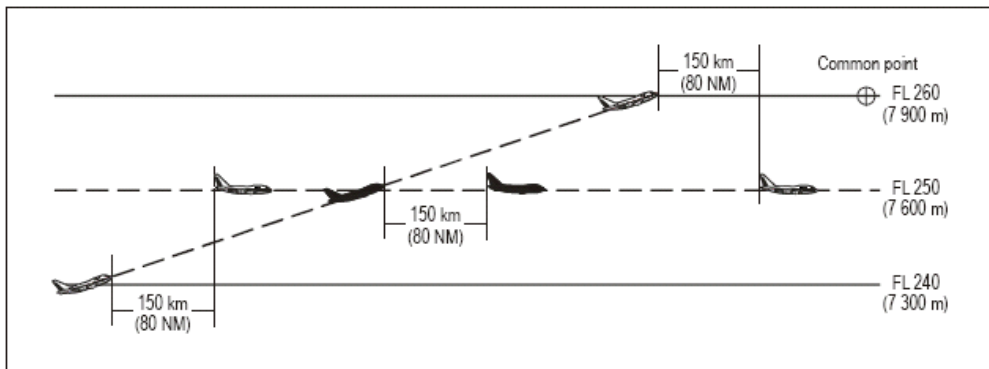

Figure 5-26A. 150 km (80 NM) RNAV-based separation between aircraft climbing and on same track (see 5.4.2.5.5 c))

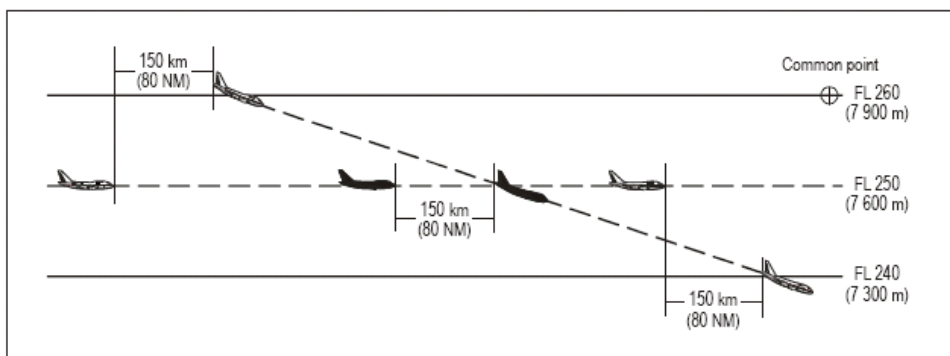

Figure 5-26B. 150 km (80 NM) RNAV-based separation between aircraft descending and on same track (see 5.4.2.5.5 c))

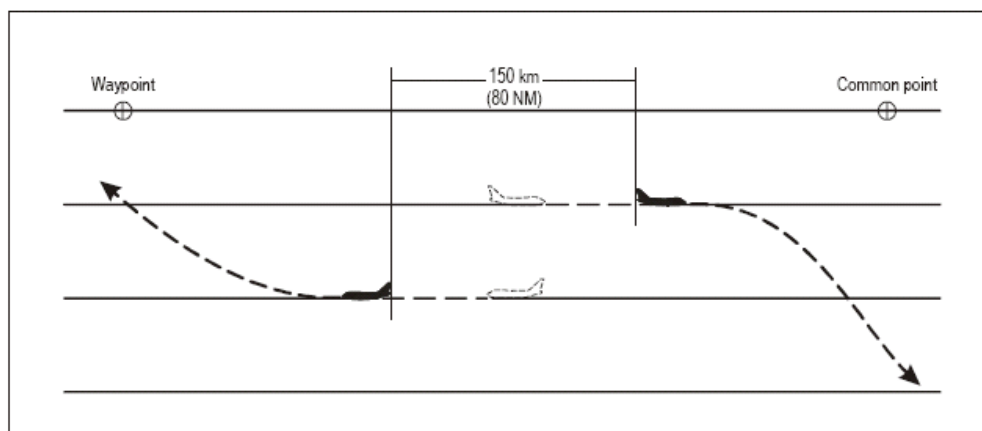

Figure 5-27. 150 km (80 NM) RNAV-based separation between aircraft on reciprocal tracks (see 5.4.2.5.7)

5.4.2.6 LONGITUDINAL SEPARATION MINIMA BASED ON DISTANCE USING RNAV WHERE RNP IS SPECIFIED

Note.— Guidance material is contained in Attachment B to ICAO Annex 11, the Performance-based Navigation (PBN) Manual (Doc 9613), the Air Traffic Services Planning Manual (Doc 9426) and the Manual on Airspace Planning Methodology for the Determination of Separation Minima (Doc 9689).

5.4.2.6.1 Within designated airspace, or on designated routes, separation minima in accordance with the provisions of this section (5.4.2.6) may be used.

5.4.2.6.2 Separation shall be established by maintaining not less than the specified distance between aircraft positions as reported by reference to the same “on track” common point, whenever possible ahead of both aircraft, or by means of an automated position reporting system.

Note.— The term “on track” means that the aircraft is flying either directly inbound to or directly outbound from the station or waypoint.

5.4.2.6.2.1 When information is received indicating navigation equipment failure or deterioration below the navigation performance requirements, ATC shall then, as required, apply alternative separation minima.

5.4.2.6.2.2 Direct controller-pilot communications shall be maintained while applying a distance-based separation minima. Direct controller-pilot communications shall be voice or CPDLC. The communication criteria necessary for CPDLC to satisfy the requirement for direct controller-pilot communications shall be established by an appropriate safety assessment.

Note.— The communication criteria which are used as a basis for the derivation of the separation minima in this section are set out in Appendix 5 of the Manual on Airspace Planning Methodology for the Determination of Separation Minima (Doc 9689). Guidance material for CPDLC is contained in the Manual of Air Traffic Services Data Link Applications (Doc 9694).

5.4.2.6.2.2.1 Prior to and during the application of a distance-based separation minimum, the controller should determine the adequacy of the available communication link, considering the time element required to receive replies from two or more aircraft, and the overall workload/traffic volume associated with the application of such minima.

5.4.2.6.2.3 When aircraft are at, or are expected to reduce to, the minimum separation applicable, speed control techniques, including assigning Mach number, shall be applied to ensure that the minimum distance exists throughout the period of application of the minima.

5.4.2.6.3 LONGITUDINAL DISTANCE-BASED SEPARATION MINIMA IN AN RNP RNAV ENVIRONMENT NOT USING ADS-C

5.4.2.6.3.1 For aircraft cruising, climbing or descending on the same track, the following separation minimum may be used:

<i>Separation minimum</i>	<i>RNP type</i>	<i>Communication requirement</i>	<i>Surveillance requirement</i>	<i>Distance verification requirements</i>
50NM	10	Direct controller-pilot communications	Procedural position reports	At least every 24 minutes

Note 1.— Where a considerable change of level is involved using distance-based separation, a descending aircraft may be cleared to some convenient level above the lower aircraft, or a climbing aircraft to some convenient level below the higher aircraft (e.g. 4 000 ft or less) to permit a further check on the separation that will be maintained while vertical separation does not exist.

Note 2.— It should be noted that the separation minimum depicted above is based on safety assessments performed specifically for a particular network of tracks or routes. As such, the assessments evaluated traffic characteristics which might be unique to the network being assessed.

Note 3.— The separation minimum above was developed in accordance with a collision risk analysis which dictates conditions under which this separation can be applied.

Note 4.— Detailed information on the analysis used to determine the separation minimum and on performing safety assessments is contained in the Manual on Airspace Planning Methodology for the Determination of Separation Minima (Doc 9689).

5.4.2.6.3.2 During the application of the 50 NM separation, when an aircraft fails to report its position, the controller shall take action within 3 minutes to establish communication. If communication has not been established within 8 minutes of the time the report should have been received, the controller shall take action to apply an alternative form of separation.

5.4.2.6.3.3 Where automated position reporting applies, a common time reference shall be used.

5.4.2.6.3.4 *Aircraft on reciprocal tracks.* Aircraft may be cleared to climb or descend to or through the levels occupied by the other provided that it has been positively established that the aircraft have passed each other and the distance between them is equal to at least the applicable separation minimum.

5.4.2.6.4 LONGITUDINAL DISTANCE-BASED SEPARATION MINIMA IN AN RNP RNAV ENVIRONMENT USING ADS-C

5.4.2.6.4.1 Separation based on the use of ADS-C shall be applied so that the distance between the calculated positions of the aircraft is never less than the prescribed minimum. This distance shall be obtained by one of the following methods:

a) when the aircraft are on the same identical track, the distance may be measured between the calculated positions of the aircraft or may be calculated by measuring the distances to a common point on the track (see Figures 5-28 and 5-29);

Note.— Same identical tracks are a special case of same track defined in 5.4.2.1.5 a) where the angular difference is zero degrees or reciprocal tracks defined in 5.4.2.1.5 b) where the angular difference is 180 degrees.

b) when the aircraft are on same or reciprocal non-parallel tracks other than in a) above, the distance shall be calculated by measuring the distances to the common point of intersection of the tracks or projected track (see Figures 5-30 to 5-32); and

c) when the aircraft are on parallel tracks whose protection areas overlap, the distance shall be measured along the track of one of the aircraft as in a) above using its calculated position and the point abeam the calculated position of the other aircraft (see Figure 5-33).

Note.— In all cases presented in Figures 5-28 to 5-33, “d” is calculated by subtracting the distance of the closer aircraft from the common point from the distance of the more distant aircraft from the common point, except in Figure 5-32 where the two distances are added and the order of the aircraft is not important in the calculation.

5.4.2.6.4.2 When aircraft are at, or are expected to reduce to, the minimum separation applicable, speed control techniques, including assigning Mach number, shall be applied to ensure that the minimum distance exists throughout the period of application of the minima.

5.4.2.6.4.3 For aircraft cruising, climbing or descending on the same track, the following separation minima may be used:

<i>Separation minima</i>	<i>RNP type</i>	<i>Maximum ADS-C periodic reporting interval</i>
50 NM	10	27 minutes
	4	32 minutes
30 NM	4	14 minutes

Note 1.— Detailed information on the analysis used to determine these separation minima and on performing safety assessments, including examples of communication media and operational assumptions that can satisfy the intervention requirements, are contained in the Manual on Airspace Planning Methodology for the Determination of Separation Minima (Doc 9689). The indicated periodic reporting intervals are specific to the use of ADS-C and are derived from performed safety assessments. As a result, these intervals may differ from those required for use with other procedural RNAV longitudinal separation minima.

Note 2.— The separation minima shown in the above table require specific RNP values and are based on collision risk modelling which determines communications and surveillance requirements. However, this modelling does not include all operational and technical aspects and is dependent upon parameter values that may vary depending on the particular airspace where the minimum will be applied. Therefore, prior to implementation, a system verification of sufficient duration and integrity must be performed to assess such parameters and conditions including weather deviations or other contingency events for the airspace concerned and to demonstrate that operational and technical requirements are met.

5.4.2.6.4.3.1 Operational and technical requirements for the provision of ADS-C services shall comply with the provisions in Chapter 13.

Note.— Before implementation, particular attention should be given to the requirements in Chapter 13, 13.4.3 and 13.4.3.4.6.

5.4.2.6.4.3.2 The communication system provided to enable the application of the separation minima in 5.4.2.6.4.3 shall allow a controller, within 4 minutes, to intervene and resolve a potential conflict by contacting an aircraft using the normal means of communication. An alternative means shall be available to allow the controller to intervene and resolve the conflict within a total time of 10½ minutes, should the normal means of communication fail.

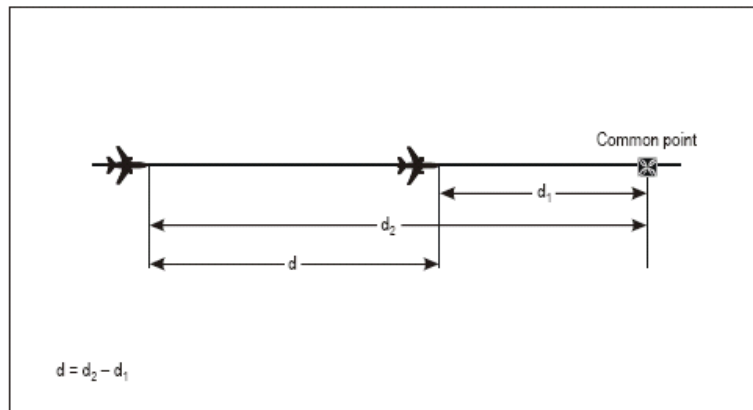

Figure 5-28. Calculation of longitudinal distance between aircraft — identical track, same direction (see 5.4.2.6.4.1 a)

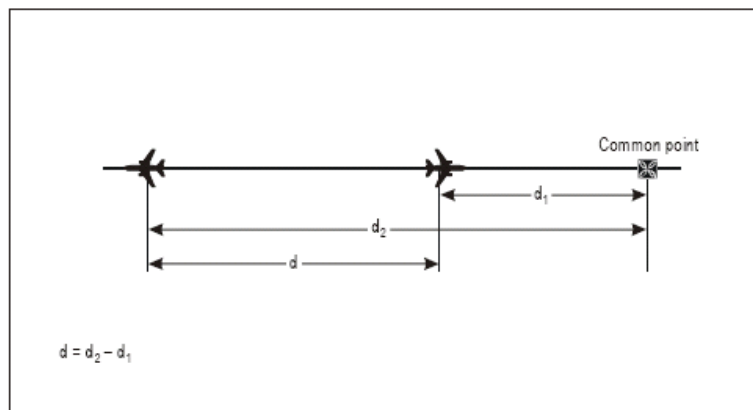

Figure 5-29. Calculation of longitudinal distance between aircraft — identical track, opposite direction (see 5.4.2.6.4.1 a)

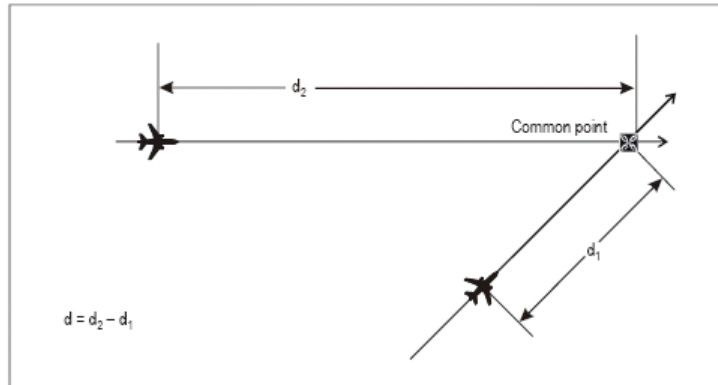

Figure 5-30. Calculation of longitudinal distance between aircraft — same track, but not identical (see 5.4.2.6.4.1 b))

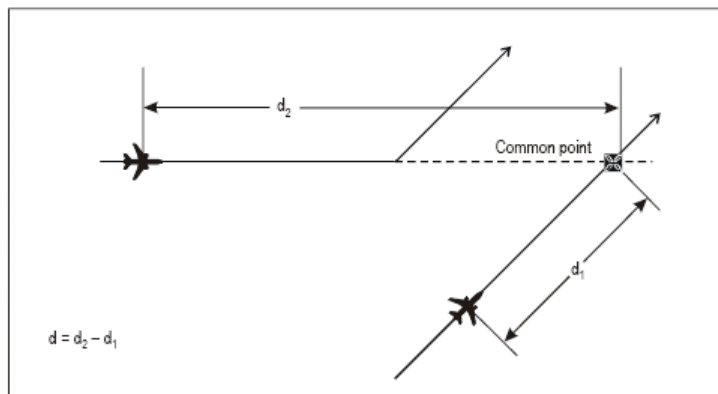

Figure 5-31. Calculation of longitudinal distance between aircraft — same track projected, but not identical (see 5.4.2.6.4.1 b))

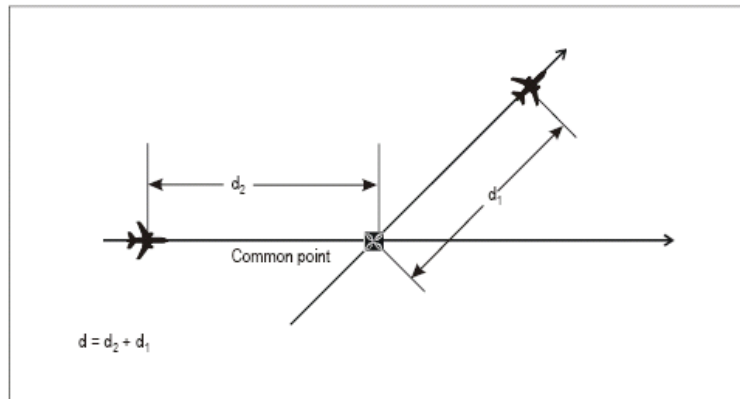

Figure 5-32. Calculation of longitudinal distance between aircraft — opposite sides of the common point (see 5.4.2.6.4.1 b)

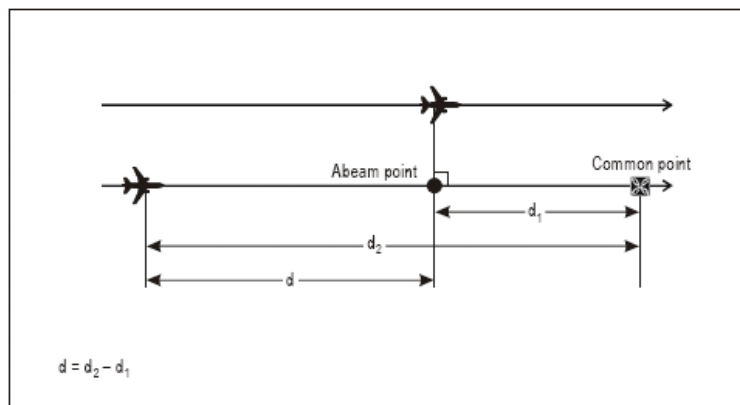

Figure 5-33. Calculation of longitudinal distance between aircraft — parallel tracks (see 5.4.2.6.4.1 c)

5.4.2.6.4.3.3 When an ADS-C periodic or waypoint change event report is not received within 3 minutes of the time it should have been sent, the report is considered overdue and the controller shall take action to obtain the report as quickly as possible, normally by ADS-C or CPDLC. If a report is not received within 6 minutes of the time the original report should have been sent, and there is a possibility of loss of separation with other aircraft, the controller shall take action to resolve any potential conflict(s) as soon as possible. The communication means provided shall be such that the conflict is resolved within a further 7½ minutes.

5.4.2.6.4.4 Opposite-direction aircraft on reciprocal tracks may be cleared to climb or descend to or through the levels occupied by another aircraft provided that the aircraft have passed each other by the applicable separation minimum, calculated in accordance with 5.4.2.6.4.1.

5.5 SEPARATION OF AIRCRAFT HOLDING IN FLIGHT

5.5.1 Aircraft established in adjacent holding patterns shall, except when lateral separation between the holding areas exists as determined by the ANSP, be separated by the applicable vertical separation minimum.

5.5.2 Except when lateral separation exists, vertical separation shall be applied between aircraft holding in flight and other aircraft, whether arriving, departing or en route, whenever the other aircraft concerned are within five minutes flying time of the holding area or within a distance prescribed by the appropriate authority (See Figure 5-34.).

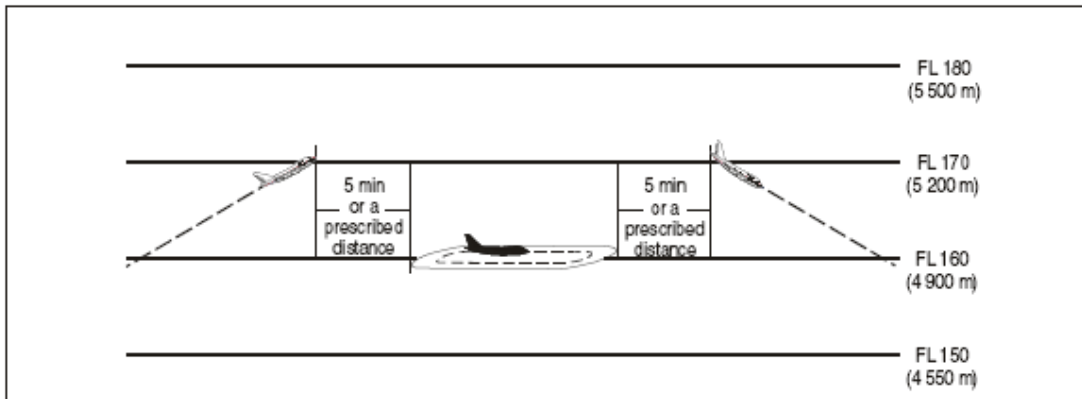

Figure 5-34. Separation between holding aircraft and en route aircraft (see 5.5.2)

5.6 MINIMUM SEPARATION BETWEEN DEPARTING AIRCRAFT

Note.— The following provisions are complementary to the longitudinal separation minima specified in Section 5.4.2.

5.6.1 One-minute separation is required if aircraft are to fly on tracks diverging by at least 45 degrees immediately after take-off so that lateral separation is provided (see Figure 5-35). This minimum may be reduced when aircraft are using parallel runways or when the procedure in Chapter 6, 6.3.3.1, is adopted for operations on diverging runways which do not cross, provided instructions covering the procedure have been approved by the ANSP and lateral separation is effected immediately after take-off.

Note 1.— Wake turbulence categories of aircraft are contained in Chapter 4, Section 4.9.1 and longitudinal separation minima are contained in Section 5.9 and in Chapter 8, Section 8.7.

Note 2.— Detailed characteristics of wake vortices and their effect on aircraft are contained in the Air Traffic Services Planning Manual (Doc 9426), Part II, Section 5.

5.6.2 Two minutes are required between take-offs when the preceding aircraft is 40 kt or more faster than the following aircraft and both aircraft will follow the same track (see Figure 5-36).

Note.— See Chapter 4, Section 4.6, concerning speed control instructions. Calculations, based on TAS, of speed differentials of aircraft during climb may not be sufficiently accurate in all circumstances for determining if the procedure in 5.6.2 can be applied, in which case calculations based on IAS may be more suitable.

5.6.3 Five-minute separation is required while vertical separation does not exist if a departing aircraft will be flown through the level of a preceding departing aircraft and both aircraft propose to follow the same track (see Figure 5-37). Action must be taken to ensure that the five-minute separation will be maintained or increased while vertical separation does not exist.

5.7 SEPARATION OF DEPARTING AIRCRAFT FROM ARRIVING AIRCRAFT

5.7.1 Except as otherwise prescribed by the ANSP, the following separation shall be applied when take-off clearance is based on the position of an arriving aircraft:

5.7.1.1 If an arriving aircraft is making a complete instrument approach, a departing aircraft may take off:

- a) in any direction until an arriving aircraft has started its procedure turn or base turn leading to final approach;
- b) in a direction which is different by at least 45 degrees from the reciprocal of the direction of approach after the arriving aircraft has started procedure turn or base

turn leading to final approach, provided that the takeoff will be made at least 3 minutes before the arriving aircraft is estimated to be over the beginning of the instrument runway (see Figure 5-38).

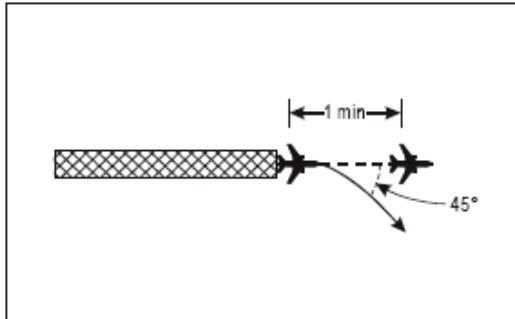

Figure 5-35. One-minute separation between departing aircraft following tracks diverging by at least 45 degrees (see 5.6.1)

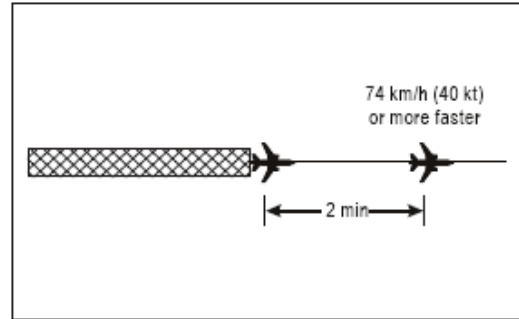

Figure 5-36. Two-minute separation between aircraft following same track (see 5.6.2)

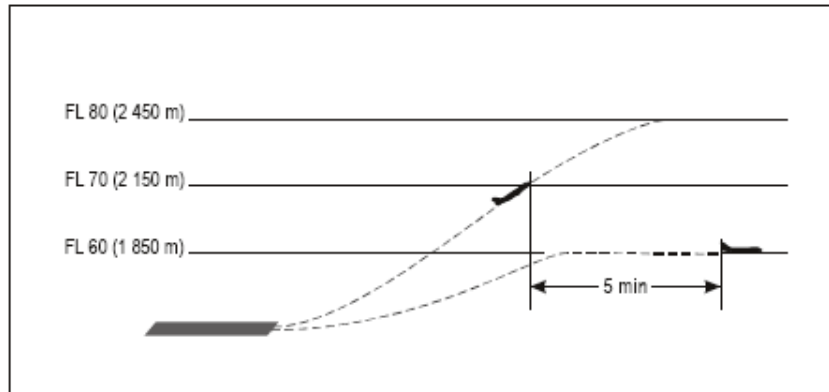

Figure 5-37. Five-minute separation of departing aircraft following the same track (see 5.6.3)

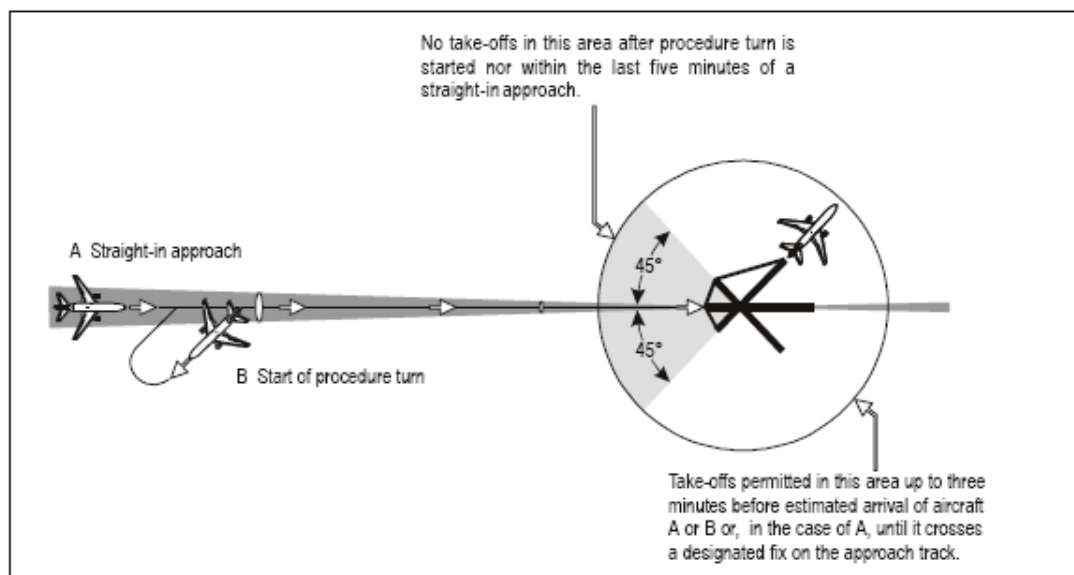

Figure 5-38. Separation of departing aircraft from arriving aircraft (see 5.7.1.1 b) and 5.7.1.2 b))

5.7.1.2 If an arriving aircraft is making a straight-in approach, a departing aircraft may take off:

- a) in any direction until 5 minutes before the arriving aircraft is estimated to be over the instrument runway;
- b) in a direction which is different by at least 45 degrees from the reciprocal of the direction of approach of the arriving aircraft:
 - 1) until 3 minutes before the arriving aircraft is estimated to be over the beginning of the instrument runway (see Figure 5-38), or
 - 2) before the arriving aircraft crosses a designated fix on the approach track; the location of such fix to be determined by the ANSP after consultation with the operators.

5.8 TIME-BASED WAKE TURBULENCE LONGITUDINAL SEPARATION MINIMA

Note.— Distance-based wake turbulence separation minima are set forth in Chapter 8, 8.7.3.4.

5.8.1 Applicability

5.8.1.1 The ATC unit concerned shall not be required to apply wake turbulence separation:

- a) for arriving VFR flights landing on the same runway as a preceding landing HEAVY or MEDIUM aircraft; and
- b) between arriving IFR flights executing visual approach when the aircraft has reported the preceding aircraft in sight and has been instructed to follow and maintain own separation from that aircraft.

5.8.1.2 The ATC unit shall, in respect of the flights specified in 5.8.1.1 (a) and (b), as well as when otherwise deemed necessary, issue a caution of possible wake turbulence. The pilot-in-command of the aircraft concerned shall be responsible for ensuring that the spacing from a preceding aircraft of a heavier wake turbulence category is acceptable. If it is determined that additional spacing is required, the flight crew shall inform the ATC unit accordingly, stating their requirements.

5.8.2 Arriving aircraft

5.8.2.1 Except as provided for in 5.8.1.1 a) and b), the following separation minima shall be applied:

5.8.2.1.1 The following non-radar separation should be applied to aircraft landing behind an A380-800 aircraft; behind a HEAVY or a MEDIUM aircraft:

- a) MEDIUM aircraft behind an A380-800 aircraft — 3 minutes;
- b) LIGHT aircraft behind an A380-800 aircraft — 4 minutes
- c) MEDIUM aircraft behind HEAVY aircraft — 2 minutes;
- d) LIGHT aircraft behind a HEAVY or MEDIUM aircraft — 3 minutes.

5.8.3 Departing aircraft

5.8.3.1 A minimum separation of 3 minutes shall be applied for a LIGHT or MEDIUM aircraft and 2 minutes for a non-A380-800 HEAVY aircraft taking off behind an A380-800 aircraft when the aircraft are using:

- a) the same runway;
- b) parallel runways separated by less than 2 500 ft;
- c) parallel runways separated by 2 500 ft or more, if the projected flight path of the second aircraft will cross the projected flight path of the first aircraft at the same altitude or less than 1 000 ft below.

Note.— See Figures 5-39 and 5-40.

5.8.3.2 A separation minimum of 4 minutes shall be applied for a LIGHT or MEDIUM aircraft when taking off behind an A380-800 and 3 minutes shall be applied between a LIGHT or MEDIUM aircraft when taking off behind a HEAVY aircraft or a LIGHT aircraft when taking off behind a MEDIUM aircraft from:

- a) an intermediate part of the same runway; or
- b) an intermediate part of a parallel runway separated by less than 2 500 ft.

Note.— See Figure 5-41.

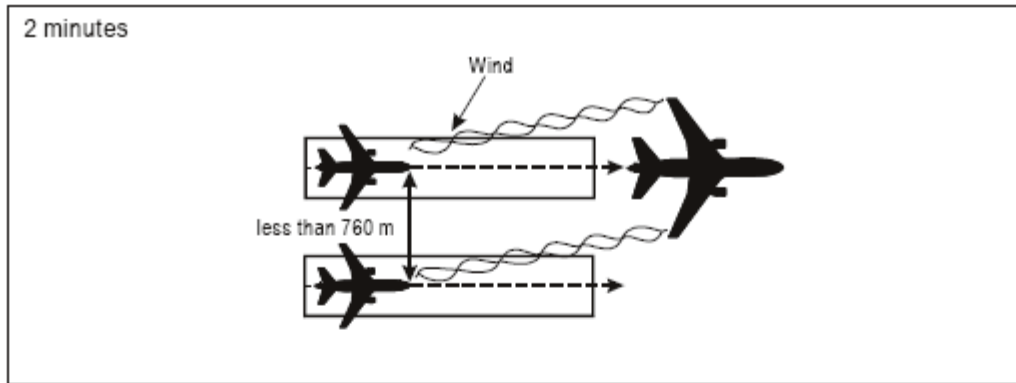

Figure 5-39. Two-minute separation for following aircraft
(see 5.8.3.1 a) and b))

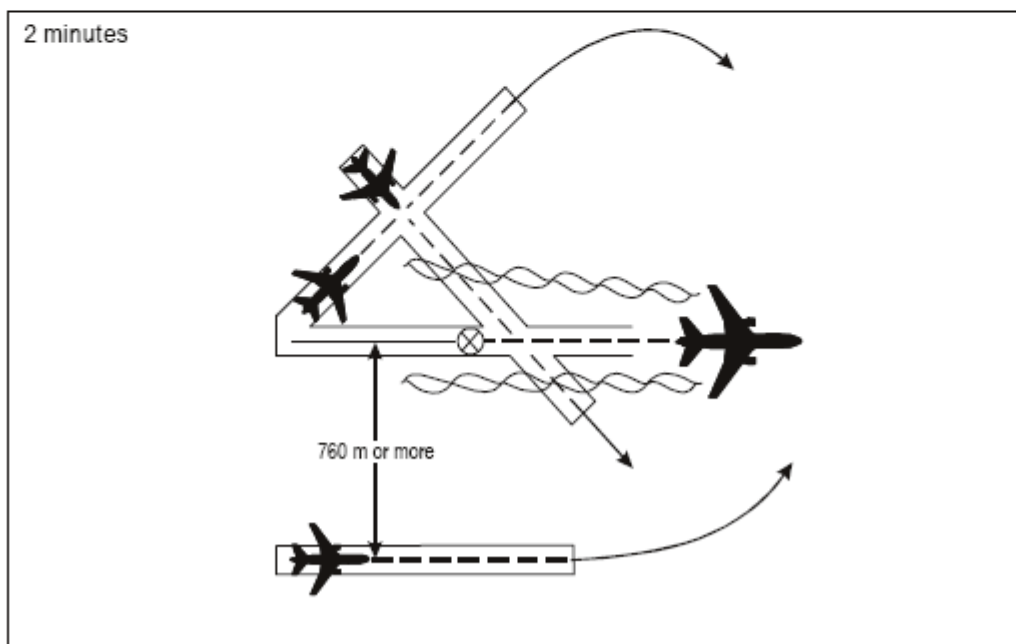

Figure 5-40. Two-minute wake turbulence separation for crossing aircraft
(see 5.8.3.1 c) and d))

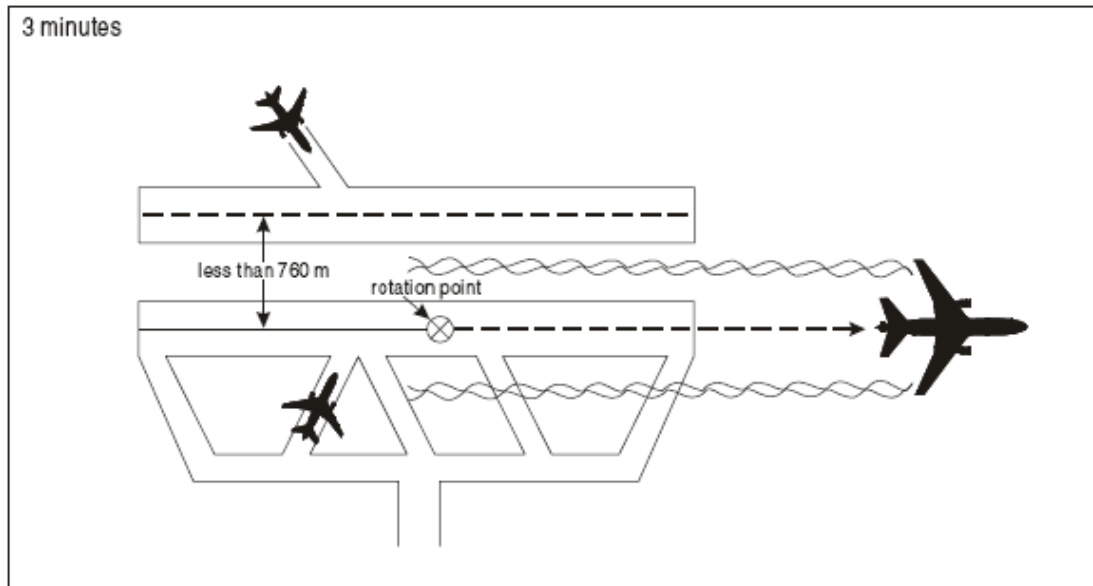

Figure 5-41. Three-minute wake turbulence separation for following aircraft (see 5.8.3.2)

5.8.4 Displaced landing threshold

5.8.4.1 A separation minimum of 3 minutes should be applied between a LIGHT or MEDIUM aircraft and an A380-800 aircraft when operating on a runway with a displaced landing threshold when:

- a) a departing LIGHT or MEDIUM aircraft follows an A380-800 aircraft arrival; or
- b) an arriving LIGHT or MEDIUM aircraft follows an A380-800 aircraft departure if the projected flight paths are expected to cross.

5.8.4.2 A separation minimum of 2 minutes shall be applied between a LIGHT or MEDIUM aircraft and a HEAVY aircraft and between a LIGHT aircraft and a MEDIUM aircraft when operating on a runway with a displaced landing threshold when:

- a) a departing LIGHT or MEDIUM aircraft follows a HEAVY aircraft arrival and a departing LIGHT aircraft follows a MEDIUM aircraft arrival; or
- b) an arriving LIGHT or MEDIUM aircraft follows a HEAVY aircraft departure and an arriving LIGHT aircraft follows a MEDIUM aircraft departure if the projected flight paths are expected to cross.

5.8.5 Opposite direction

5.8.5.1 A separation of 3 minutes should be applied between a LIGHT or MEDIUM aircraft and an A380-800 aircraft when the A380-800 aircraft is making a low or missed approach and the LIGHT or MEDIUM aircraft is:

- a) utilizing an opposite-direction runway for take-off; or
- b) landing on the same runway in the opposite direction, or on a parallel opposite-direction runway separated by less than 2 500 ft.

5.8.5.2 A separation minimum of 2 minutes shall be applied between a LIGHT or MEDIUM aircraft and a HEAVY aircraft and between a LIGHT aircraft and a MEDIUM aircraft when the heavier aircraft is making a low or missed approach and the lighter aircraft is:

- a) utilizing an opposite-direction runway for take-off; or

Note.— See Figure 5-42.

- b) landing on the same runway in the opposite direction, or on a parallel opposite-direction runway separated by less than 2 500 ft.

Note.— See Figure 5-43.

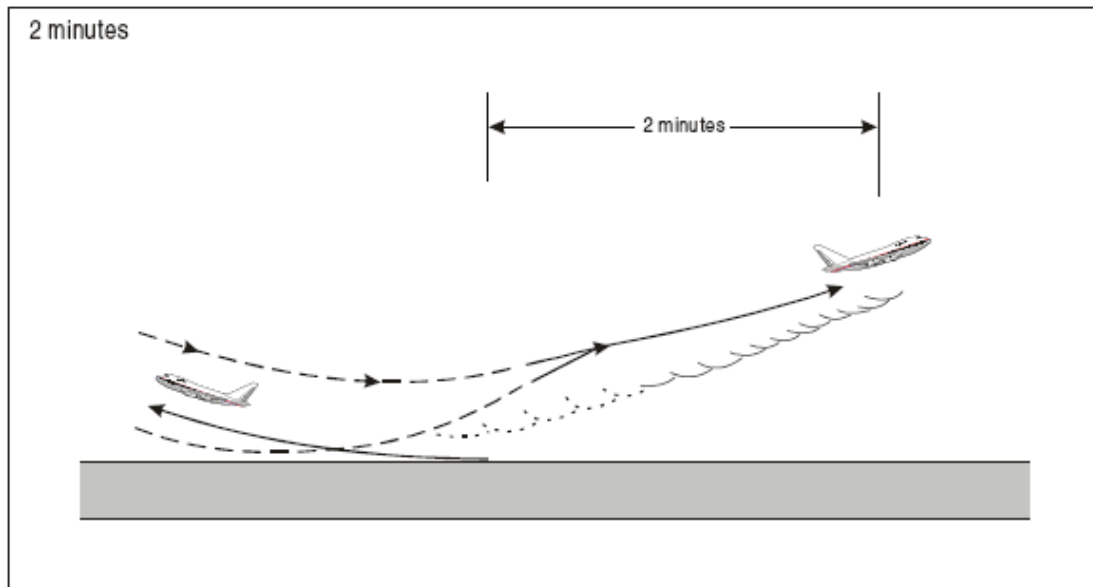

Figure 5-42. Two-minute wake turbulence separation for opposite direction take-off (see 5.8.5 a))

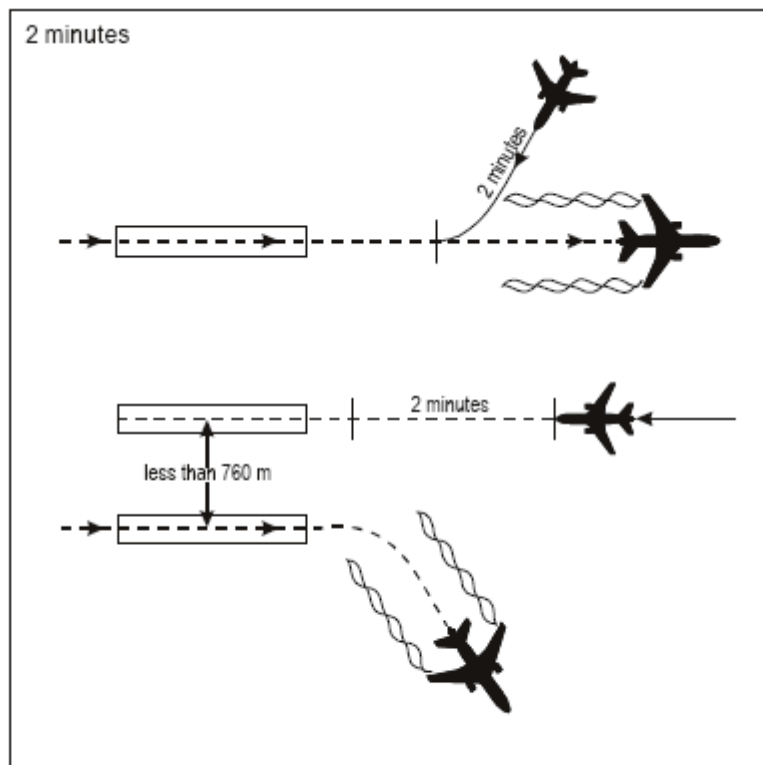

Figure 5-43. Two-minute wake turbulence separation for opposite direction landing (see 5.8.5 b))

5.9 CLEARANCES TO FLY MAINTAINING OWN SEPARATION WHILE IN VISUAL METEOROLOGICAL CONDITIONS

Note: This section is reserved.

5.10 ESSENTIAL TRAFFIC INFORMATION

5.10.1 General

5.10.1.1 Essential traffic is that controlled traffic to which the provision of separation by ATC is applicable, but which, in relation to a particular controlled flight is not, or will not be, separated from other controlled traffic by the appropriate separation minimum.

Note.— Pursuant to Section 5.2 of Chapter 5, but subject to certain exceptions stated therein, ATC is required to provide separation between IFR flights in airspace Classes A to E, and between IFR and VFR flights in Classes B and C. ATC is not required to provide separation between VFR flights, except within airspace Class B. Therefore, IFR or VFR flights may constitute essential traffic to IFR traffic, and IFR flights may constitute essential traffic to VFR traffic. However, a VFR flight would not constitute essential traffic to other VFR flights except within Class B airspace.

5.10.1.2 Essential traffic information shall be given to controlled flights concerned whenever they constitute essential traffic to each other.

Note.— This information will inevitably relate to controlled flights cleared subject to maintaining own separation and remaining in visual meteorological conditions and also whenever the intended separation minimum has been infringed.

5.10.2 Information to be provided

5.10.2.1 Essential traffic information shall include:

- a) direction of flight of aircraft concerned;
- b) type and wake turbulence category (if relevant) of aircraft concerned;
- c) cruising level of aircraft concerned; and
 - 1) estimated time over the reporting point nearest to where the level will be crossed; or
 - 2) relative bearing of the aircraft concerned in terms of the 12-hour clock as well as distance from the conflicting traffic; or
 - 3) actual or estimated position of the aircraft concerned.

Note 1. — Nothing in Section 5.10 is intended to prevent ATC from imparting to aircraft under its control any other information at its disposal with a view to enhancing air safety in accordance with the objectives of ATS as defined in Chapter 2 of ICAO Annex 11.

Note 2.— Wake turbulence category will only be essential traffic information if the aircraft concerned is of a heavier wake turbulence category than the aircraft to which the traffic information is directed.

Note.— See also Chapter 2, ATS safety management.

5.11 REDUCTION IN SEPARATION MINIMA

Note.— See also Chapter 2, ATS safety management.

5.11.1 Provided an appropriate safety assessment has shown that an acceptable level of safety will be maintained, and after prior consultation with users, the separation minima detailed in 5.4.1 and 5.4.2 may be reduced in the following circumstances:

5.11.1.1 As determined by the ANSP:

- a) when special electronic or other aids enable the pilot-in-command of an aircraft to determine accurately the aircraft's position and when adequate communication facilities exist for that position to be transmitted without delay to the appropriate air traffic control unit; or
- b) when, in association with rapid and reliable communication facilities, information of an aircraft's position derived from an ATS surveillance system, is available to the appropriate air traffic control unit; or
- c) when special electronic or other aids enable the air traffic controller to predict rapidly and accurately the flight paths of aircraft, and adequate facilities exist to verify frequently the actual aircraft positions with the predicted positions; or
- d) when RNAV-equipped aircraft operate within the coverage of electronic aids that provide the necessary updates to maintain navigation accuracy.

Note.— Attention is drawn to the guidance material contained in the Air Traffic Services Planning Manual (Doc 9426) regarding conditions governing the reduction of separation minima and to the Manual on Airspace Planning Methodology for the Determination of Separation Minima (Doc 9689).

CHAPTER 6

SEPARATION IN THE VICINITY OF AERODROMES

6.1 REDUCTION IN SEPARATION MINIMA IN THE VICINITY OF AERODROMES

6.1.1 In addition to the circumstances mentioned in Chapter 5, 5.11.1, the separation minima detailed in Chapter 5, 5.4.1 and 5.4.2, may be reduced in the vicinity of aerodromes if:

- a) adequate separation can be provided by the aerodrome controller when each aircraft is continuously visible to this controller; or
- b) each aircraft is continuously visible to flight crews of the other aircraft concerned and the pilots thereof report that they can maintain their own separation; or
- c) in the case of one aircraft following another, the flight crew of the succeeding aircraft reports that the other aircraft is in sight and separation can be maintained.

6.2 ESSENTIAL LOCAL TRAFFIC

6.2.1 Information on essential local traffic known to the controller shall be transmitted without delay to departing and arriving aircraft concerned.

Note 1.— Essential local traffic in this context consists of any aircraft, vehicle or personnel on or near the runway to be used, or traffic in the take-off and climb-out area or the final approach area, which may constitute a collision hazard to a departing or arriving aircraft.

Note 2.— See also Chapter 5, Section 5.10, Chapter 7, 7.3.1.3 and Chapter 8, 8.8.2.

6.2.1.1 Essential local traffic shall be described so as to be easily identified.

6.3 PROCEDURES FOR DEPARTING AIRCRAFT

6.3.1 General

6.3.1.1 Clearances for departing aircraft shall specify, when necessary for the separation of aircraft, direction of takeoff and turn after take-off; heading or track to be made good before taking up the cleared departure track; level to maintain before continuing climb to assigned level; time, point and/or rate at which a level change shall

be made; and any other necessary manoeuvre consistent with safe operation of the aircraft.

6.3.1.2 At aerodromes where standard instrument departures (SIDs) have been established, departing aircraft should normally be cleared to follow the appropriate SID.

6.3.2 Standard clearances for departing aircraft

6.3.2.1 GENERAL

6.3.2.1.1 The ANSP should, wherever possible, establish standardized procedures for transfer of control between the ATC units concerned, and standard clearances for departing aircraft.

Note.— The provisions applying to standardized procedures for coordination and transfer of control are specified in Chapter 10, Section 10.4.1.

6.3.2.2 COORDINATION

6.3.2.2.1 Where standard clearances for departing aircraft have been agreed to between the units concerned, the aerodrome control tower will normally issue the appropriate standard clearance without prior coordination with or approval from the approach control unit or ACC.

6.3.2.2.2 Prior coordination of clearances should be required only in the event that a variation to the standard clearance or the standardized transfer of control procedures is necessary or desirable for operational reasons.

6.3.2.2.3 Provision shall be made to ensure that the approach control unit at all times is kept informed of the sequence in which aircraft will depart as well as the runway to be used.

6.3.2.2.4 Provision shall be made to display the designators of assigned SIDs to the aerodrome control tower, the approach control unit and/or the ACC as applicable.

6.3.2.3 CONTENTS

6.3.2.3.1 Standard clearances for departing aircraft shall contain the following items:

- a) aircraft identification;
- b) clearance limit, normally destination aerodrome;
- c) designator of the assigned SID, if applicable;
- d) initial level, except when this element is included in the SID description;

- e) allocated SSR code;
- f) any other necessary instructions or information not contained in the SID description, e.g. instructions relating to change of frequency.

6.3.2.4 CLIMB CLEARANCE ABOVE LEVELS SPECIFIED IN A SID

Note.— See also 11.4.2.6.2.5.

6.3.2.4.1 When a departing aircraft on a SID is cleared to climb to a level higher than the initially cleared level or the level(s) specified in a SID, the aircraft shall follow the published vertical profile of a SID, unless such restrictions are explicitly cancelled by ATC.

6.3.2.5 COMMUNICATION FAILURE

6.3.2.5.1 Clearances for departing aircraft may specify an initial or intermediate level other than that indicated in the filed flight plan for the en route phase of flight, without a time or geographical limit for the initial level. Such clearances will normally be used to facilitate the application of tactical control methods by ATC, normally through the use of an ATS surveillance system.

6.3.2.5.2 If applicable, when clearances for departing aircraft containing no time or geographical limit for an initial or intermediate level are utilized, action to be taken by an aircraft experiencing air-ground communication failure in the event the aircraft has been radar vectored away from the route specified in its current flight plan, should be described and published in the AIP.

6.3.3 Departure sequence

6.3.3.1 Departing aircraft may be expedited by suggesting a take-off direction which is not into the wind. It is the responsibility of the pilot-in-command of an aircraft to decide between making such a take-off or waiting for take-off in a preferred direction.

6.3.3.2 If departures are delayed, the delayed flights shall normally be cleared in an order based on their estimated time of departure, except that deviation from this order may be made to:

- a) facilitate the maximum number of departures with the least average delay;
- b) accommodate requests by an operator in respect of that operator's flights to the extent practicable.

6.3.3.3 Air traffic control units should when practicable advise aircraft operators or their designated representatives when anticipated delays are expected to exceed 30 minutes.

6.4 INFORMATION FOR DEPARTING AIRCRAFT

Note.— See Chapter 11, 11.4.3, regarding flight information messages.

6.4.1 Meteorological conditions

6.4.1.1 Information regarding significant changes in the meteorological conditions in the take-off or climb-out area, obtained by the unit providing approach control service after a departing aircraft has established communication with such unit, shall be transmitted to the aircraft without delay, except when it is known that the aircraft already has received the information.

Note.— Significant changes in this context include those relating to surface wind direction or speed, visibility, runway visual range or air temperature (for turbine-engined aircraft), and the occurrence of thunderstorm or cumulonimbus, moderate or severe turbulence, wind shear, hail, moderate or severe icing, severe squall line, freezing precipitation, severe mountain waves, sand storm, dust storm, blowing snow, tornado or waterspout.

6.4.2 Operational status of visual or non-visual aids

6.4.2.1 Information regarding changes in the operational status of visual or non-visual aids essential for take-off and climb shall be transmitted without delay to a departing aircraft, except when it is known that the aircraft already has received the information.

6.5 PROCEDURES FOR ARRIVING AIRCRAFT

6.5.1 General

6.5.1.1 When it becomes evident that delays will be encountered by arriving aircraft, operators or designated representatives shall, to the extent practicable, be notified and kept currently informed of any changes in such expected delays.

6.5.1.2 Arriving aircraft may be required to report when leaving or passing a significant point or navigation aid, or when starting procedure turn or base turn, or to provide other information required by the controller, to expedite departing and arriving aircraft.

6.5.1.3 An IFR flight shall not be cleared for an initial approach below the appropriate minimum altitude as specified in the AIP nor to descend below that altitude unless:

- a) the pilot has reported passing an appropriate point defined by a navigation aid or as a waypoint; or
- b) the pilot reports that the aerodrome is and can be maintained in sight; or

- c) the aircraft is conducting a visual approach; or
- d) the controller has determined the aircraft's position by the use of an ATS surveillance system, and a lower minimum altitude has been specified for use when providing ATS surveillance services.

6.5.1.4 At aerodromes where standard instrument arrivals (STARs) have been established, arriving aircraft should normally be cleared to follow the appropriate STAR. The aircraft shall be informed of the type of approach to expect and runway-in-use as early as possible.

Note.— See Section 6.5.2 concerning Standard arrival clearances.

6.5.1.5 After coordination with the approach control unit, the ACC may clear the first arriving aircraft for approach rather than to a holding fix.

6.5.2 Standard clearances for arriving aircraft

6.5.2.1 GENERAL

6.5.2.1.1 The ANSP should, wherever possible, establish standardized procedures for transfer of control between the ATC units concerned and standard clearances for arriving aircraft.

Note.— The provisions applying to standardized procedures for coordination and transfer of control are specified in Chapter 10, Section 10.4.1.

6.5.2.2 COORDINATION

6.5.2.2.1 Where standard clearances for arriving aircraft are in use and, provided no terminal delay is expected, clearance to follow the appropriate STAR will normally be issued by the ACC without prior coordination with or approval from the approach control unit or the aerodrome control tower as applicable.

6.5.2.2.2 Prior coordination of clearances should be required only in the event that a variation to the standard clearance or the standardized transfer of control procedures is necessary or desirable for operational reasons.

6.5.2.2.3 Provision shall be made to ensure that the approach control unit is at all times kept informed of the sequence of aircraft following the same STAR.

6.5.2.2.4 Provision shall be made to display the designators of assigned STARs to the ACC, the approach control unit and/or the aerodrome control tower, as applicable.

6.5.2.3 CONTENTS

6.5.2.3.1 Standard clearances for arriving aircraft shall contain the following items:

-
- a) aircraft identification;
 - b) designator of the assigned STAR;
 - c) runway-in-use, except when part of the STAR description;
 - d) initial level, except when this element is included in the STAR description; and
 - e) any other necessary instructions or information not contained in the STAR description, e.g. change of communications.

6.5.2.4 DESCENT BELOW LEVELS SPECIFIED IN A STAR

Note.— See also 11.4.2.6.2.5.

6.5.2.4.1 When an arriving aircraft on a STAR is cleared to descend to a level lower than the level or the level(s) specified in a STAR, the aircraft shall follow the published vertical profile of a STAR, unless such restrictions are explicitly cancelled by ATC. Published minimum levels based on terrain clearance shall always be applied.

6.5.3 Visual approach

6.5.3.1 Subject to the conditions in 6.5.3.3, clearance for an IFR flight to execute a visual approach may be requested by a flight crew or initiated by the controller. In the latter case, the concurrence of the flight crew shall be required.

6.5.3.2 Controllers shall exercise caution in initiating a visual approach when there is reason to believe that the flight crew concerned is not familiar with the aerodrome and its surrounding terrain. Controllers should also take into consideration the prevailing traffic and meteorological conditions when initiating visual approaches.

6.5.3.3 An IFR flight may be cleared to execute a visual approach provided the pilot can maintain visual reference to the terrain and:

- a) the reported ceiling is at or above the level of the beginning of the initial approach segment for the aircraft so cleared; or
- b) the pilot reports at the level of the beginning of the initial approach segment or at any time during the instrument approach procedure that the meteorological conditions are such that with reasonable assurance a visual approach and landing can be completed.

6.5.3.4 Separation shall be provided between an aircraft cleared to execute a visual approach and other arriving and departing aircraft.

6.5.3.5 For successive visual approaches, separation shall be maintained by the controller until the pilot of a succeeding aircraft reports having the preceding aircraft in sight. The aircraft shall then be instructed to follow and maintain own separation from the preceding aircraft. When both aircraft are of a heavy wake turbulence category, or the preceding aircraft is of a heavier wake turbulence category than the

following, and the distance between the aircraft is less than the appropriate wake turbulence minimum, the controller shall issue a caution of possible wake turbulence. The pilot-in-command of the aircraft concerned shall be responsible for ensuring that the spacing from a preceding aircraft of a heavier wake turbulence category is acceptable. If it is determined that additional spacing is required, the flight crew shall inform the ATC unit accordingly, stating their requirements.

6.5.3.6 Transfer of communications to the aerodrome controller should be effected at such a point or time that information on essential local traffic, if applicable, and clearance to land or alternative instructions can be issued to the aircraft in a timely manner.

6.5.4 Instrument approach

6.5.4.1 The approach control unit shall specify the instrument approach procedure to be used by arriving aircraft. A flight crew may request an alternative procedure and, if circumstances permit, should be cleared accordingly.

6.5.4.2 If a pilot reports or it is clearly apparent to the ATC unit that the pilot is not familiar with an instrument approach procedure, the initial approach level, the point (in minutes from the appropriate reporting point) at which base turn or procedure turn will be started, the level at which the procedure turn shall be carried out and the final approach track shall be specified, except that only the last-mentioned need be specified if the aircraft is to be cleared for a straight-in approach. The frequency(ies) of the navigation aid(s) to be used as well as the missed approach procedure shall also be specified when deemed necessary.

6.5.4.3 If visual reference to terrain is established before completion of the approach procedure, the entire procedure must nevertheless be executed unless the aircraft requests and is cleared for a visual approach.

6.5.5 Holding

6.5.5.1 In the event of extended delays, aircraft should be advised of the anticipated delay as early as possible and, when practicable, be instructed or given the option to reduce speed en route in order to absorb delay.

6.5.5.2 When delay is expected, the ACC shall normally be responsible for clearing aircraft to the holding fix, and for including holding instructions, and expected approach time or onward clearance time, as applicable, in such clearances. (See Section 6.5.8.)

6.5.5.3 After coordination with the approach control unit, the ACC may clear an arriving aircraft to a visual holding location to hold until further advised by the approach control unit.

6.5.5.4 After coordination with the aerodrome control tower, the approach control unit may clear an arriving aircraft to a visual holding location to hold until further advised by the aerodrome control tower.

6.5.5.5 Holding and holding pattern entry shall be accomplished in accordance with procedures established by the ANSP and published in AIP. If entry and holding procedures have not been published or if the procedures are not known to a flight crew, the appropriate air traffic control unit shall specify the designator of the location or aid to be used, the inbound track, radial or bearing, direction of turn in the holding pattern as well as the time of the outbound leg or the distances between which to hold.

6.5.5.6 Aircraft should normally be held at a designated holding fix. The required minimum vertical, lateral or longitudinal separation from other aircraft shall be provided. Criteria and procedures for the simultaneous use of adjacent holding patterns shall be prescribed in local instructions.

Note.— See Chapter 5, Section 5.5, concerning separation of aircraft holding in flight.

6.5.5.7 Levels at a holding fix or visual holding location shall as far as practicable be assigned in a manner that will facilitate clearing each aircraft to approach in its proper priority. Normally, the first aircraft to arrive over a holding fix or visual holding location should be at the lowest level, with following aircraft at successively higher levels.

6.5.5.8 When extended holding is anticipated, turbojet aircraft should, when practicable, be permitted to hold at higher levels in order to conserve fuel, whilst retaining their order in the approach sequence.

6.5.5.9 If an aircraft is unable to comply with the published or cleared holding procedure, alternative instructions shall be issued.

6.5.5.10 For the purpose of maintaining a safe and orderly flow of traffic, an aircraft may be instructed to orbit at its present or at any other position, provided the required obstacle clearance is ensured.

6.5.6 Approach sequence

6.5.6.1 GENERAL

6.5.6.1.1 The following procedures shall be applied whenever approaches are in progress.

6.5.6.1.2 The approach sequence shall be established in a manner which will facilitate arrival of the maximum number of aircraft with the least average delay. Priority shall be given to:

- a) an aircraft which anticipates being compelled to land because of factors affecting the safe operation of the aircraft (engine failure, shortage of fuel, etc.);
- b) hospital aircraft or aircraft carrying any sick or seriously injured person requiring urgent medical attention;

-
- c) aircraft engaged in search and rescue operations; and
 - d) other aircraft as may be determined by the appropriate authority.

Note.— An aircraft which has encountered an emergency is handled as outlined in Chapter 15, Section 15.1.

6.5.6.1.3 Succeeding aircraft shall be cleared for approach:

- a) when the preceding aircraft has reported that it is able to complete its approach without encountering instrument meteorological conditions; or
- b) when the preceding aircraft is in communication with and sighted by the aerodrome control tower and reasonable assurance exists that a normal landing can be accomplished, or
- c) when timed approaches are used, the preceding aircraft has passed the defined point inbound and reasonable assurance exists that a normal landing can be accomplished;

Note.— See 6.5.6.2.1 concerning timed approach procedures.

- d) when the use of an ATS surveillance system confirms that the required longitudinal spacing between succeeding aircraft has been established.

6.5.6.1.4 In establishing the approach sequence, the need for increased longitudinal spacing between arriving aircraft due to wake turbulence shall be taken into account.

6.5.6.1.5 If the pilot of an aircraft in an approach sequence has indicated an intention to hold for weather improvement, or for other reasons, such action shall be approved. However, when other holding aircraft indicate intention to continue their approach-to-land, the pilot desiring to hold will be cleared to an adjacent fix for holding awaiting weather change or re-routing. Alternatively, the aircraft should be given a clearance to place it at the top of the approach sequence so that other holding aircraft may be permitted to land. Coordination shall be effected with any adjacent ATC unit or control sector, when required, to avoid conflict with the traffic under the jurisdiction of that unit or sector.

6.5.6.1.6 When establishing the approach sequence, an aircraft which has been authorized to absorb a specified period of notified terminal delay by cruising at a reduced speed enroute, should, in so far as practicable, be credited with the time absorbed en route.

6.5.6.2 SEQUENCING AND SPACING OF INSTRUMENT APPROACHES

6.5.6.2.1 TIMED APPROACH PROCEDURES

6.5.6.2.1.1 The ANSP should utilize the following procedure as necessary to expedite the approaches of a number of arriving aircraft:

a) a suitable point on the approach path, which shall be capable of being accurately determined by the pilot, shall be specified, to serve as a check point in timing successive approaches;

b) aircraft shall be given a time at which to pass the specified point inbound, which time shall be determined with the aim of achieving the desired interval between successive landings on the runway while respecting the applicable separation minima at all times, including the period of runway occupancy.

6.5.6.2.1.2 The time at which aircraft should pass the specified point shall be determined by the unit providing approach control service and notified to the aircraft sufficiently in advance to permit the pilot to arrange the flight path accordingly.

6.5.6.2.1.3 Each aircraft in the approach sequence shall be cleared to pass the specified point inbound at the previously notified time, or any revision thereof, after the preceding aircraft has reported passing the point inbound.

6.5.6.2.2 ***INTERVAL BETWEEN SUCCESSIVE APPROACHES***

6.5.6.2.2.1 In determining the time interval or longitudinal distance to be applied between successive approaching aircraft, the relative speeds between succeeding aircraft, the distance from the specified point to the runway, the need to apply wake turbulence separation, runway occupancy times, the prevailing meteorological conditions as well as any condition which may affect runway occupancy times shall be considered. When an ATS surveillance system is used to establish an approach sequence, the minimum distance to be established between succeeding aircraft shall be specified in local instructions. Local instructions shall additionally specify the circumstances under which any increased longitudinal distance between approaches may be required as well as the minima to be used under such circumstances.

6.5.6.2.3 ***INFORMATION ON APPROACH SEQUENCE***

6.5.6.2.3.1 Provision shall be made to ensure that the aerodrome control tower is kept informed of the sequence in which aircraft will be established on final approach for landing.

Note 1.— Guidance material on factors to be taken into account when determining separation for timed approaches is contained in the Air Traffic Services Planning Manual (Doc 9426).

Note 2.— Wake turbulence categories and non-radar wake turbulence separation minima are contained in Chapter 4, Section 4.9 and Chapter 5, Section 5.8 and Chapter 8, Section 8.7.

Note 3.— Detailed characteristics of wake vortices and their effect on aircraft are contained in the Air Traffic Services Planning Manual (Doc 9426), Part II, Section 5.

6.5.7 **Expected approach time**

6.5.7.1 An expected approach time shall be determined for an arriving aircraft that will be subjected to a delay of 10 minutes or more or such other period as has been determined by the ANSP. The expected approach time shall be transmitted to the

aircraft as soon as practicable and preferably not later than at the commencement of its initial descent from cruising level. A revised expected approach time shall be transmitted to the aircraft without delay whenever it differs from that previously transmitted by 5 minutes or more, or such lesser period of time as has been established by the ATS units or agreed between the ATS units concerned.

6.5.7.2 An expected approach time shall be transmitted to the aircraft by the most expeditious means whenever it is anticipated that the aircraft will be required to hold for 30 minutes or more.

6.5.7.3 The holding fix to which an expected approach time relates shall be identified together with the expected approach time whenever circumstances are such that this would not otherwise be evident to the pilot.

6.5.8 Onward clearance time

6.5.8.1 In the event an aircraft is held en route or at a location or aid other than the initial approach fix, the aircraft concerned shall, as soon as practicable, be given an expected onward clearance time from the holding fix. The aircraft shall also be advised if further holding at a subsequent holding fix is expected.

Note.— “Onward clearance time” is the time at which an aircraft can expect to leave the fix at which it is being held.

6.6 INFORMATION FOR ARRIVING AIRCRAFT

Note.— See Chapter 11, 11.4.3 regarding flight information messages.

6.6.1 As early as practicable after an aircraft has established communication with the unit providing approach control service, the following elements of information, in the order listed, shall be transmitted to the aircraft, with the exception of such elements which it is known the aircraft has already received:

- a) type of approach and runway-in-use;
- b) meteorological information, as follows:
 - 1) surface wind direction and speed, including significant variations;
 - 2) visibility and, when applicable, runway visual range (RVR);
 - 3) present weather;
 - 4) cloud below 1 500 m (5 000 ft) or below the highest minimum sector altitude, whichever is greater; cumulonimbus; if the sky is obscured, vertical visibility when available;

-
- 5) air temperature;
 - 6) dew point temperature;
 - 7) altimeter setting(s);
 - 8) any available information on significant meteorological phenomena in the approach area; and
 - 9) trend-type landing forecast, when available.

Note.— The meteorological information listed above is identical to that required in ATIS broadcasts for arriving aircraft as specified in ICAO Annex 11, 4.3.7 j) to r) and is to be extracted from local meteorological routine and special reports, in accordance with Chapter 11, 11.4.3.2.2 to 11.4.3.2.3.9.

- c) current runway surface conditions, in case of precipitants or other temporary hazards;
- d) changes in the operational status of visual and non-visual aids essential for approach and landing.

6.6.2 In applying the provisions in 6.7.3.1.1, it should be recognized that information published by NOTAM or disseminated by other means may not have been received by the aircraft prior to departure or during en-route flight.

6.6.3 If it becomes necessary or operationally desirable that an arriving aircraft follow an instrument approach procedure or use a runway other than that initially stated, the flight crew shall be advised without delay.

6.6.4 At the commencement of final approach, the following information shall be transmitted to aircraft:

- a) significant changes in the mean surface wind direction and speed;

Note.— Significant changes are specified in ICAO Annex 3, Chapter 4. However, if the controller possesses wind information in the form of components, the significant changes are:

- Mean head-wind component: 10 kt
- Mean tail-wind component: 2 kt
- Mean cross-wind component: 5 kt

- b) the latest information, if any, on wind shear and/or turbulence in the final approach area;
- c) the current visibility representative of the direction of approach and landing or, when provided, the current runway visual range value(s) and the trend.

6.6.5 During final approach, the following information shall be transmitted without delay:

- a) the sudden occurrence of hazards (e.g. unauthorized traffic on the runway);

- b) significant variations in the current surface wind, expressed in terms of minimum and maximum values;
- c) significant changes in runway surface conditions;
- d) changes in the operational status of required visual or non-visual aids;
- e) changes in observed RVR value(s), in accordance with the reported scale in use, or changes in the visibility representative of the direction of approach and landing.

6.7 OPERATIONS ON PARALLEL OR NEAR-PARALLEL RUNWAYS

6.7.1 General

6.7.1.1 Where parallel or near-parallel runways are used for simultaneous operations, the requirements and procedures below shall apply.

Note.— Guidance material is contained in the Manual on Simultaneous Operations on Parallel or Near-Parallel Instrument Runways (SOIR) (Doc 9643).

6.7.2 Departing aircraft

6.7.2.1 TYPES OF OPERATION

6.7.2.1.1 Parallel runways may be used for independent instrument departures as follows:

- a) both runways are used exclusively for departures (independent departures);
- b) one runway is used exclusively for departures while the other runway is used for a mixture of arrivals and departures (semi-mixed operation); and
- c) both runways are used for mixed arrivals and departures (mixed operation).

6.7.2.2 REQUIREMENTS AND PROCEDURES FOR INDEPENDENT PARALLEL DEPARTURES

6.7.2.2.1 Independent IFR departures may be conducted from parallel runways provided:

- a) the runway centre lines are spaced by the distance specified in ICAO Annex 14, Volume I;
- b) the departure tracks diverge by at least 15 degrees immediately after take-off;

- c) suitable surveillance radar capable of identification of the aircraft within 1.0 NM from the end of the runway is available; and
- d) ATS operational procedures ensure that the required track divergence is achieved.

6.7.3 Arriving aircraft

6.7.3.1 TYPES OF OPERATIONS

6.7.3.1.1 Parallel runways may be used for simultaneous instrument operations for:

- a) independent parallel approaches; or
- b) dependent parallel approaches; or
- c) segregated parallel operations.

6.7.3.1.2 Whenever parallel approaches are carried out, separate controllers should be responsible for the sequencing and spacing of arriving aircraft to each runway.

6.7.3.2 REQUIREMENTS AND PROCEDURES FOR INDEPENDENT PARALLEL APPROACHES

6.7.3.2.1 Independent parallel approaches may be conducted to parallel runways provided that:

- a) the runway centre lines are spaced by the distance specified in ICAO Annex 14, Volume I; and
 - 1) where runway centre lines are spaced by less than 1310m but not less than 1 035 m, suitable secondary surveillance radar (SSR) equipment, with a minimum azimuth accuracy of 0.06 degrees (one sigma), an update period of 2.5 seconds or less and a high resolution display providing position prediction and deviation alert, is available; or
 - 2) where runway centre lines are spaced by less than 1525m but not less than 1310m, SSR equipment with performance specifications other than the foregoing may be applied, provided they are equal to or better than those stated under (3) below, and when it is determined that the safety of aircraft operation would not be adversely affected; or
 - 3) where runway centre lines are spaced by 1525m or more, suitable surveillance radar with a minimum azimuth accuracy of 0.3 degrees (one sigma) or better and update period of 5 seconds or less is available;

For the above cases, other equivalent ATS surveillance systems (e.g. ADS-B or MLAT) may be used to provide the services detailed above provided that a

performance capability equal to or better than that required for the above can be demonstrated.

Note. — Guidance material pertaining to use of ADS-B and multilateration (MLAT) systems and their system performance is contained in the Assessment of Automatic Dependent Surveillance – Broadcast (ADS-B) and Multilateration Surveillance to Support Air Traffic Services and Guidelines for Implementation (Cir 326).

- b) instrument landing system (ILS) approaches are being conducted on both runways;
- c) the missed approach track for one approach diverges by at least 30 degrees from the missed approach track of the adjacent approach;
- d) an obstacle survey and evaluation is completed, as appropriate, for the areas adjacent to the final approach segments;
- e) aircraft are advised of the runway identification and ILS localizer as early as possible;
- f) vectoring is used to intercept the ILS localizer course;
- g) a no transgression zone (NTZ) at least 610m (2000ft) wide is established equidistant between extended runway centre lines and is depicted on the situation display;
- h) separate controllers monitor the approaches to each runway and ensure that when the 300m (1000ft) vertical separation is reduced:
 - 1) aircraft do not penetrate the depicted NTZ; and
 - 2) the applicable minimum longitudinal separation between aircraft on the same ILS localizer course is maintained; and
- i) if no dedicated radio channels are available for the controllers to control the aircraft until landing:
 - 1) transfer of communication of aircraft to the respective aerodrome controller's channels effected before the higher of two aircraft on adjacent final approach tracks intercepts the ILS glide path; and
 - 2) the controllers monitoring the approaches to each runway are provided with the capability to override transmissions of aerodrome control on the respective radio channels for each arrival flow.

6.7.3.2.2 As early as practicable after an aircraft has established communication with approach control, the aircraft shall be advised that independent parallel approaches are in force. This information may be provided through the ATIS broadcasts.

6.7.3.2.3 When vectoring to intercept the ILS localizer course, the final vector shall enable the aircraft to intercept the ILS localizer course at an angle not greater than 30 degrees and to provide at least 2 km (1.0 NM) straight and level flight prior to ILS localizer course intercept. The vector shall also enable the aircraft to be established on the ILS localizer course in level flight for at least 3.7 km (2.0 NM) prior to intercepting the ILS glide path.

6.7.3.2.4 A minimum of 300 m (1 000 ft) vertical separation or, subject to radar system and situation display capabilities, a minimum of 5.6 km (3.0 NM) radar separation shall be provided until aircraft are established:

- a) inbound on the ILS localizer course and/or MLS final approach track; and
- b) within the normal operating zone (NOZ).

6.7.3.2.5 Subject to radar system and situation display capabilities, a minimum of 5.6km (3.0 NM) radar separation shall be provided between aircraft on the same ILS localizer course unless increased longitudinal separation is required due to wake turbulence or for other reasons.

Note 1.— See Chapter 8, 8.7.3.4.

Note 2.— An aircraft established on an ILS localizer course or MLS final approach track is separated from another aircraft established on an adjacent parallel ILS localizer course provided neither aircraft penetrates the NTZ as depicted on the situation display.

6.7.3.2.6 When assigning the final heading to intercept the ILS localizer course, the runway shall be confirmed, and the aircraft shall be advised of:

- a) its position relative to a fix on the ILS localizer course;
- b) the altitude to be maintained until established on the ILS localizer course to the ILS glidepath; and
- c) if required, clearance for the appropriate ILS approach.

6.7.3.2.7 All approaches regardless of meteorological conditions shall be provided with flight path monitoring using radar. Control instructions and information necessary to ensure separation between aircraft and to ensure aircraft do not enter the NTZ shall be issued.

Note 1.— The primary responsibility for navigation on the ILS localizer course rests with the pilot. Control instructions and information are therefore issued only to ensure separation between aircraft and to ensure that aircraft do not penetrate the NTZ.

Note 2.— For the purpose of ensuring an aircraft does not penetrate the NTZ, the aircraft is considered to be the centre of its position symbol. However, the edges of the position symbols representing aircraft executing parallel approaches are not allowed to touch (see Chapter 8, 8.7.2).

6.7.3.2.8 When an aircraft is observed to overshoot the turn-on or to continue on a track which will penetrate the NTZ, the aircraft shall be instructed to return immediately to the correct track.

6.7.3.2.9 When an aircraft is observed penetrating the NTZ, the aircraft on the adjacent ILS localizer course or MLS final approach track shall be instructed to immediately climb and turn to the assigned altitude/height and heading in order to avoid the deviating aircraft. Where parallel approach obstacle assessment surfaces (PAOAS) criteria are applied for the obstacle assessment, the air traffic controller shall not issue the heading instruction to the aircraft below 120 m (400 ft) above the runway threshold elevation, and the heading instruction shall not exceed 45 degrees track difference with the ILS localizer course.

6.7.3.2.10 Flight path monitoring using radar shall not be terminated until:

- a) visual separation is applied, provided procedures ensure that both controllers are advised whenever visual separation is applied;
- b) the aircraft has landed, or in case of a missed approach, is at least 2 km (1.0 NM) beyond the departure end of the runway and adequate separation with any other traffic is established.

Note.— There is no requirement to advise the aircraft that flight path monitoring using radar is terminated.

6.7.3.3 **SUSPENSION OF INDEPENDENT PARALLEL APPROACHES TO CLOSELY-SPACED PARALLEL RUNWAYS**

6.7.3.3.1 Independent parallel approaches to parallel runways spaced by less than 1 525 m between their centre lines shall be suspended under certain meteorological conditions, as prescribed by the ANSP, including windshear, turbulence, downdrafts, crosswind and significant meteorological conditions such as thunderstorms, which might otherwise increase ILS localizer course deviations to the extent that safety may be impaired.

Note 1.— The increase in final approach track deviations would additionally result in an unacceptable level of deviation alerts being generated.

Note 2.— Guidance material relating to meteorological conditions is contained in the Manual on Simultaneous Operations on Parallel or Near-Parallel Instrument Runways (Doc 9643).

6.7.3.4 **REQUIREMENTS AND PROCEDURES FOR DEPENDENT PARALLEL APPROACHES**

6.7.3.4.1 Dependent parallel approaches may be conducted to parallel runways provided:

- a) the runway centre lines are spaced by the distance specified in ICAO Annex 14, Volume I;

- b) the aircraft are vectored to intercept the final approach track;
- c) suitable surveillance radar with a minimum azimuth accuracy of 0.3 degrees (one sigma) and update period of 5 seconds or less is available;
- d) ILS approaches are being conducted on both runways;
- e) aircraft are advised that approaches are in use to both runways (this information may be provided through the ATIS);
- f) the missed approach track for one approach diverges by at least 30 degrees from the missed approach track of the adjacent approach; and
- g) approach control has a frequency override capability to aerodrome control.

6.7.3.4.2 A minimum of 300 m (1 000 ft) vertical separation or a minimum of 5.6 km (3.0 NM) radar separation shall be provided between aircraft during turn-on to parallel ILS localizer courses.

6.7.3.4.3 The minimum horizontal separation to be provided between aircraft established on the same final approach course or track shall be 5.6 km (3.0 NM), unless increased longitudinal separation is required due to wake turbulence.

6.7.3.4.4 The minimum horizontal separation to be provided diagonally between successive aircraft on adjacent final approach courses or tracks shall be:

- a) 3.7 km (2.0 NM) between successive aircraft on adjacent final approach courses or tracks more than 2 529 m (8 300 ft) apart; or
- b) 2.8 km (1.5 NM) between successive aircraft on adjacent final approach courses or tracks more than 1 097 m (3 600 ft) but not more than 2 529 m (8 300 ft) apart.

6.7.3.5 **REQUIREMENTS AND PROCEDURES FOR SEGREGATED PARALLEL OPERATIONS**

6.7.3.5.1 Segregated parallel operations may be conducted on parallel runways provided:

- a) the runway centre lines are spaced by the distance specified in ICAO Annex 14, Volume I; and
- b) the nominal departure track diverges immediately after take-off by at least 30 degrees from the missed approach track of the adjacent approach (see Figure 6-1).

6.7.3.5.2 The minimum distance between parallel runway centre lines for segregated parallel operations may be decreased by 30 m for each 150 m that the arrival runway is staggered toward the arriving aircraft, to a minimum of 300 m (see Figure 6-2) and should be increased by 30 m for each 150 m that the arrival runway is staggered away from the arriving aircraft (see Figure 6-3).

6.7.3.5.3 The following types of approaches may be conducted in segregated parallel operations provided suitable surveillance radar and the appropriate ground facilities conform to the standard necessary for the specific type of approach:

- a) ILS and/or MLS precision approach;
- b) surveillance radar approach (SRA) or precision approach radar (PAR) approach; and
- c) visual approach.

Note.— Guidance material is contained in the Manual on Simultaneous Operations on Parallel or Near-Parallel Instrument Runways (Doc 9643).

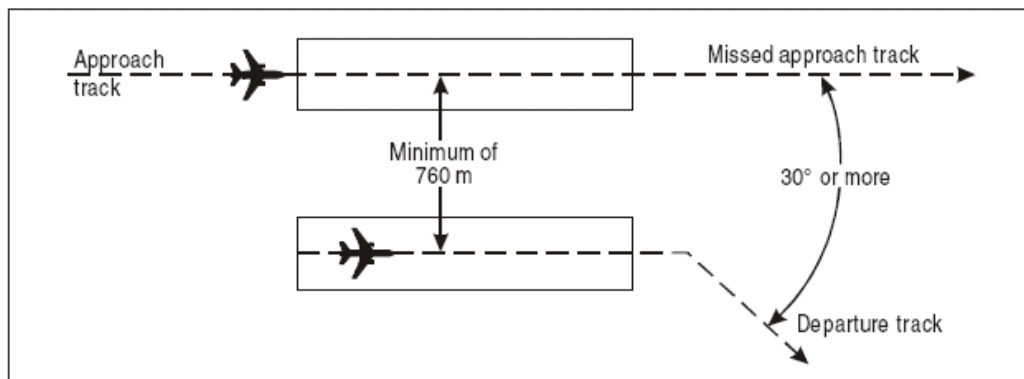

Figure 6-1. Segregated parallel operations (see 6.7.3.5.1 b))

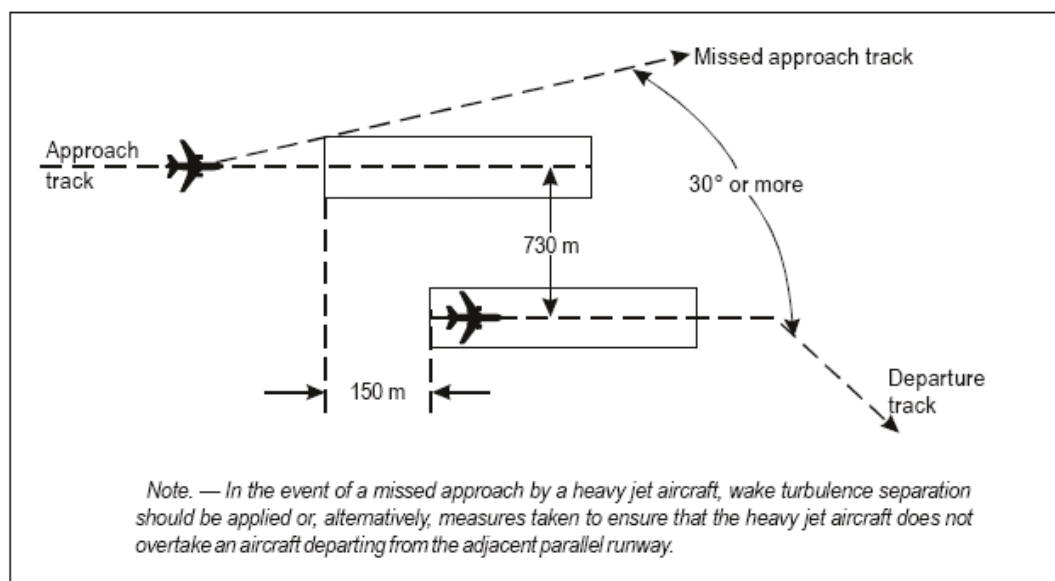

Figure 6-2. Segregated parallel operations where runways are staggered (see 6.7.3.5.2)

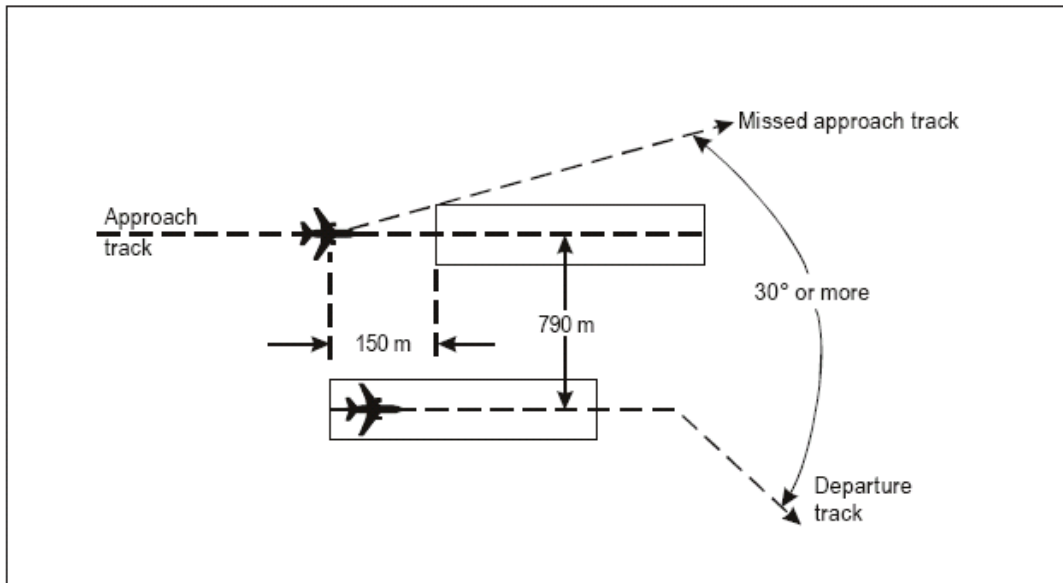

Figure 6-3. Segregated parallel operations where runways are staggered
(see 6.7.3.5.2)

CHAPTER 7

PROCEDURES FOR AERODROME CONTROL SERVICE

Note.— This Chapter also includes procedures for the operation of aeronautical ground lights, see Section 7.14.

7.1 FUNCTIONS OF AERODROME CONTROL TOWERS

7.1.1 General

7.1.1.1 Aerodrome control towers shall issue information and clearances to aircraft under their control to achieve a safe, orderly and expeditious flow of air traffic on and in the vicinity of an aerodrome with the object of preventing collision(s) between:

- a) aircraft flying within the designated area of responsibility of the control tower, including the aerodrome traffic circuits;
- b) aircraft operating on the manoeuvring area;
- c) aircraft landing and taking off;
- d) aircraft and vehicles operating on the manoeuvring area;
- e) aircraft on the manoeuvring area and obstructions on that area.

7.1.1.2 Aerodrome controllers shall maintain a continuous watch on-

- a) all flight operations on and in the vicinity of an aerodrome; and
- b) on vehicles and personnel on the manoeuvring area by visual observation, which may be augmented by an ATS surveillance system, when available.

7.1.1.2A Traffic shall be controlled in accordance with the procedures set forth in Chapter 7 and all applicable traffic rules specified by the ANSP in the ANSP's operations manual.

Note.— Provisions for the use of an ATS surveillance system in the aerodrome control service are contained in Chapter 8, Section 8.10.

7.1.1.3 The functions of an aerodrome control tower may be performed by different control or working positions, such as

-
- aerodrome operations on the runway and aircraft flying within the area of responsibility of the aerodrome control tower;
 - ground controller, normally responsible for traffic on the manoeuvring area with the exception of runways;
 - clearance delivery position, normally responsible for delivery of start-up and ATC clearances to departing IFR flights.

7.1.3A Use of a visual surveillance system in aerodrome control service

7.1.3A.1 The ANSP may use a visual surveillance system for its provision of aerodrome control services provided that:

- a) the technical capabilities of the system are capable of enabling the ANSP to provide the services at a level that is commensurate with the traffic density and complexity at the aerodrome;
- (b) there are backup facilities or alternative operational procedures; and
- (c) the ANSP has satisfied the ANS regulator, based on a safety risk assessment carried out by the ANSP, that the system is of an acceptable level of reliability, availability and integrity.

7.1.1.4 Where parallel or near-parallel runways are used for simultaneous operations, individual aerodrome controllers should be responsible for operations on each of the runways.

7.1.2 Alerting service provided by aerodrome control towers

7.1.2.1 Aerodrome control towers are responsible for alerting the rescue and fire fighting services whenever:

- a) an aircraft accident has occurred on or in the vicinity of the aerodrome; or,
- b) information is received that the safety of an aircraft which is or will come under the jurisdiction of the aerodrome control tower may have or has been impaired; or
- c) requested by the flight crew; or
- d) when otherwise deemed necessary or desirable.

7.1.2.2 Procedures concerning the alerting of the rescue and fire fighting services shall be contained in local instructions. Such instructions shall specify the type of information to be provided to the rescue and fire fighting services, including type of aircraft and type of emergency and, when available, number of persons on board, and any dangerous goods carried on the aircraft.

7.1.2.3 Aircraft which fail to report after having been transferred to an aerodrome control tower, or, having once reported, cease radio contact and in either case fail to land five minutes after the expected landing time, shall be reported to the approach control unit, ACC or flight information centre, or to the rescue coordination centre or rescue sub-centre, in accordance with local instructions.

7.1.3 Information on the operational status of navigation services

7.1.3.1 ATS units shall be kept currently informed of the operational status of radio navigation services and visual aids essential for take-off, departure, approach and landing procedures within their area of responsibility and those radio navigation services and visual aids essential for surface movement.

7.1.4 Failure or irregularity of aids and equipment

7.1.4.1 Aerodrome control towers shall immediately report in accordance with local instructions any failure or irregularity of operation in any equipment, light or other device established at an aerodrome for the guidance of aerodrome traffic and flight crews or required for the provision of air traffic control service.

7.2 SELECTION OF RUNWAY-IN-USE

7.2.1 The term “runway-in-use” shall be used to indicate the runway or runways that, at a particular time, are considered by the aerodrome control tower to be the most suitable for use by the types of aircraft expected to land or take off at the aerodrome.

Note.— Separate or multiple runways may be designated runway-in-use for arriving aircraft and departing aircraft.

7.2.2 Normally, an aircraft will land and take off into wind unless safety, the runway configuration, meteorological conditions and available instrument approach procedures or air traffic conditions determine that a different direction is preferable. In selecting the runway-in-use, however, the unit providing aerodrome control service shall take into consideration, besides surface wind speed and direction, other relevant factors such as the aerodrome traffic circuits, the length of runways, and the approach and landing aids available.

7.2.3 A runway for take-off or landing, appropriate to the operation, may be nominated for noise abatement purposes, the objective being to utilize whenever possible those runways that permit aeroplanes to avoid noise-sensitive areas during the initial departure and final approach phases of flight.

7.2.4 Runways should not be selected for noise abatement purposes for landing operations unless they are equipped with suitable glide path guidance, e.g. ILS, or a visual approach slope indicator system for operations in visual meteorological conditions.

7.2.5 A pilot-in-command, prompted by safety concerns, can refuse a runway offered for noise-preferential reasons.

7.2.6 Noise abatement shall not be a determining factor in runway nomination under the following circumstances:

- a) if the runway surface conditions are adversely affected (e.g. by snow, slush, ice, water, mud, rubber, oil or other substances);
- b) for landing in conditions:
 - 1) when the ceiling is lower than 150 m (500 ft) above aerodrome elevation, or the visibility is less than 1 900 m; or
 - 2) when the approach requires use to be made of vertical minima greater than 100 m (300 ft) above aerodrome elevation and:
 - i) the ceiling is lower than 240 m (800 ft) above aerodrome elevation; or
 - ii) the visibility is less than 3 000 m;
- c) for take-off when the visibility is less than 1 900 m;
- d) when wind shear has been reported or forecast or when thunderstorms are expected to affect the approach or departure; and
- e) when the crosswind component, including gusts, exceeds 28 km/h (15 kt), or the tailwind component, including gusts, exceeds 9 km/h (5 kt).

7.3 INITIAL CALL TO AERODROME CONTROL TOWER

7.3.1 For aircraft being provided with aerodrome control service, the initial call shall contain:

- a) designation of the station being called;
- b) call sign and, for A380-800 aircraft, the expression “SUPER” and non-A380-800 HEAVY aircraft in the heavy wake turbulence category, the word “Heavy”;
- c) position; and
- d) additional elements, as required by the ANSP.

Note.— See also Chapter 4, 4.11.3.1, for aircraft in the air, making the first call to the aerodrome tower.

7.4 INFORMATION TO AIRCRAFT BY AERODROME CONTROL TOWERS

7.4.1 Information related to the operation of aircraft

Note.— See Chapter 11, 11.4.3, regarding flight information messages.

7.4.1.1 START-UP TIME PROCEDURES

7.4.1.1.1 When so requested by the pilot prior to engine start, an expected take-off time should be given, unless engine start time procedures are employed.

7.4.1.1.2 Start-up time procedures should be implemented where necessary to avoid congestion and excessive delays on the manoeuvring area or when warranted by ATFM regulations. Start-up time procedures should be contained in local instructions, and should specify the criteria and conditions for determining when and how start-up times shall be calculated and issued to departing flights.

7.4.1.1.3 When an aircraft is subject to ATFM regulations, it should be advised to start up in accordance with its allocated slot time.

7.4.1.1.4 When delay for a departing aircraft is anticipated to be less than a time period specified by the ANSP, an aircraft should be cleared to start-up at its own discretion.

7.4.1.1.5 When delay for a departing aircraft is anticipated to exceed a time period specified by the ANSP, the aerodrome control tower should issue an expected start-up time to an aircraft requesting start-up.

7.4.1.1.6 A start-up clearance shall only be withheld under circumstances or conditions specified by the ANSP.

7.4.1.1.7 If a start-up clearance is withheld, the flight crew shall be advised of the reason.

7.4.1.2 AERODROME AND METEOROLOGICAL INFORMATION

7.4.1.2.1 Prior to taxiing for take-off, aircraft shall be advised of the following elements of information, in the order listed, with the exception of such elements which it is known the aircraft has already received:

- a) the runway to be used;
- b) the surface wind direction and speed, including significant variations therefrom;
- c) the QNH altimeter setting and, either on a regular basis in accordance with local arrangements or if so requested by the aircraft, the QFE altimeter setting;

- d) the air temperature for the runway to be used, in the case of turbine-engined aircraft;
- e) the visibility representative of the direction of take-off and initial climb, if less than 10 km, or, when applicable, the RVR value(s) for the runway to be used;
- f) the correct time.

Note.— The meteorological information listed above is to follow the criteria used for meteorological local routine and special reports, in accordance with Chapter 11, 11.4.3.2.2 to 11.4.3.2.3.9.

7.4.1.2.2 Prior to take-off aircraft shall be advised of:

- a) any significant changes in the surface wind direction and speed, the air temperature, and the visibility or RVR value(s) given in accordance with 7.4.1.2.1;
- b) significant meteorological conditions in the take-off and climb-out area, except when it is known that the information has already been received by the aircraft.

Note.— Significant meteorological conditions in this context include the occurrence or expected occurrence of cumulonimbus or thunderstorm, moderate or severe turbulence, wind shear, hail, moderate or severe icing, severe squall line, freezing precipitation, severe mountain waves, sand storm, dust storm, blowing snow, tornado or waterspout in the take-off and climb-out area.

7.4.1.2.3 Prior to entering the traffic circuit or commencing its approach to land, an aircraft shall be provided with the following elements of information, in the order listed, with the exception of such elements which it is known the aircraft has already received:

- a) the runway to be used;
- b) the surface wind direction and speed, including significant variations therefrom;
- c) the QNH altimeter setting and, either on a regular basis in accordance with local arrangements or, if so requested by the aircraft, the QFE altimeter setting.

Note.— The meteorological information listed above is to follow the criteria used for meteorological local routine and special reports, in accordance with Chapter 11, 11.4.3.2.2 to 11.4.3.2.3.9.

7.4.1.3 ESSENTIAL LOCAL TRAFFIC INFORMATION

7.4.1.3.1 Information on essential local traffic shall be issued in a timely manner, either directly or through the unit providing approach control service when, in the judgment of the aerodrome controller, such information is necessary in the interests of safety, or when requested by aircraft.

7.4.1.3.2 Essential local traffic shall be considered to consist of any aircraft, vehicle or personnel on or near the manoeuvring area or traffic operating in the vicinity of the aerodrome, which may constitute a hazard to the aircraft concerned.

7.4.1.3.3 Essential local traffic shall be described so as to be easily identified.

7.4.1.4 RUNWAY INCURSION OR OBSTRUCTED RUNWAY

7.4.1.4.1 In the event the aerodrome controller, after a take-off clearance or a landing clearance has been issued, becomes aware of a runway incursion or the imminent occurrence thereof, or the existence of any obstruction on or in close proximity to the runway likely to impair the safety of an aircraft taking off or landing, appropriate action shall be taken as follows:

- a) cancel the take-off clearance for a departing aircraft;
- b) instruct a landing aircraft to execute a go-around or missed approach;
- c) in all cases inform the aircraft of the runway incursion or obstruction and its location in relation to the runway.

Note.— *Animals and flocks of birds may constitute an obstruction with regard to runway operations. In addition, an aborted take-off or a go-around executed after touchdown may expose the aeroplane to the risk of overrunning the runway. Moreover, a low altitude missed approach may expose the aeroplane to the risk of a tail strike. Pilots may, therefore, have to exercise their judgement in accordance with ICAO Annex2, 2.4 concerning the authority of the pilot-in-command of an aircraft.*

7.4.1.4.2 Pilots and air traffic controllers shall report any occurrence involving an obstruction on the runway or a runway incursion.

Note 1 – *Information regarding runway incursion and reporting forms together with instructions for their completion are contained in the Manual on the Prevention of Runway Incursions (Doc 9870). Attention is drawn to the guidance for analysis, data collection and sharing of data related to runway incursions (see Chapter 5 of Doc 9870).*

Note 2 – *The provisions in 7.4.1.4.2 have the objective of supporting the State's safety programme and safety management system (SMS).*

7.4.1.5 UNCERTAINTY OF POSITION ON THE MANOEUVRING AREA

7.4.1.5.1 Except as provided for in 7.4.1.5.2, a pilot in doubt as to the position of the aircraft with respect to the manoeuvring area shall immediately:

- a) stop the aircraft; and
- b) simultaneously notify the control tower of the circumstances (including the last known position).

7.4.1.5.2 In those situations where a pilot is in doubt as to the position of the aircraft with respect to the manoeuvring area, but recognizes that the aircraft is on a runway, the pilot shall immediately:

-
- a) notify the control tower of the circumstances (including the last known position);
 - b) if able to locate a nearby suitable taxiway, vacate the runway as expeditiously as possible, unless otherwise instructed by the control tower; and then,
 - c) stop the aircraft.

7.4.1.5.3 A vehicle driver in doubt as to the position of the vehicle with respect to the manoeuvring area shall immediately:

- a) notify the control tower of the circumstances (including the last known position);
- b) simultaneously, unless otherwise instructed by the control tower, vacate the landing area, taxiway, or other part of the manoeuvring area, to a safe distance as expeditiously as possible; and then,
- c) stop the vehicle.

7.4.1.5.4 In the event the aerodrome controller becomes aware of an aircraft or vehicle that is lost or uncertain of its position on the manoeuvring area, appropriate action shall be taken immediately to safeguard operations and assist the aircraft or vehicle concerned to determine its position.

7.4.1.6 WAKE TURBULENCE AND JET BLAST HAZARDS

7.4.1.6.1 Aerodrome controllers shall, when applicable, apply the wake turbulence separation minima specified in Chapter 5, Section 5.8. Whenever the responsibility for wake turbulence avoidance rests with the pilot-in-command, aerodrome controllers shall, to the extent practicable, advise aircraft of the expected occurrence of hazards caused by turbulent wake.

Note.— Occurrence of turbulent wake hazards cannot be accurately predicted and aerodrome controllers cannot assume responsibility for the issuance of advice on such hazards at all times, nor for its accuracy. Information on hazards due to wake vortices is contained in the Air Traffic Services Planning Manual (Doc 9426), Part II, Section 5. Wake turbulence categories of aircraft are specified in Chapter 4, 4.9.1.

7.4.1.6.2 In issuing clearances or instructions, air traffic controllers should take into account the hazards caused by jet blast and propeller slipstream to taxiing aircraft, to aircraft taking off or landing, particularly when intersecting runways are being used, and to vehicles and personnel operating on the aerodrome.

Note.— Jet blast and propeller slipstream can produce localized wind velocities of sufficient strength to cause damage to other aircraft, vehicles and personnel operating within the affected area.

7.4.1.7 ABNORMAL AIRCRAFT CONFIGURATION AND CONDITION

7.4.1.7.1 Whenever an abnormal configuration or condition of an aircraft, including conditions such as landing gear not extended or only partly extended, or unusual smoke emissions from any part of the aircraft, is observed by or reported to the aerodrome controller, the aircraft concerned shall be advised without delay.

7.4.1.7.2 When requested by the flight crew of a departing aircraft suspecting damage to the aircraft, the departure runway used shall be inspected without delay and the flight crew advised in the most expeditious manner as to whether any aircraft debris or bird or animal remains have been found or not.

7.5 ESSENTIAL INFORMATION ON AERODROME CONDITIONS

Note.— See Chapter 11, 11.4.3.4 regarding messages containing information on aerodrome conditions.

7.5.1 Aerodrome control towers and units providing approach control service shall be kept currently informed of the operationally significant conditions of the movement area, including the existence of temporary hazards, and the operational status of any associated facilities at the aerodrome(s) with which they are concerned.

7.5.2 Essential information on aerodrome conditions is information necessary to safety in the operation of aircraft, which pertains to the movement area or any facilities usually associated therewith. For example, construction work on a taxi strip not connected to the runway-in-use would not be essential information to any aircraft except one that might be taxied in the vicinity of the construction work. As another example, if all traffic must be confined to runways, that fact should be considered as essential aerodrome information to any aircraft not familiar with the aerodrome.

7.5.3 Essential information on aerodrome conditions shall include information relating to the following:

- a) construction or maintenance work on, or immediately adjacent to the movement area;
- b) rough or broken surfaces on a runway, a taxiway or an apron, whether marked or not;
- c) water on a runway, a taxiway or an apron;
- d) other temporary hazards, including parked aircraft and birds on the ground or in the air;
- e) failure or irregular operation of part or all of the aerodrome lighting system;
- f) any other pertinent information.

Note.— Up-to-date information on the conditions on aprons may not always be available to the aerodrome control tower. The responsibility of the aerodrome control tower in relation to aprons is,

with respect to the provisions of 7.4.1 and 7.4.2, limited to the transmission to aircraft of the information which is provided to it by the authority responsible for the aprons.

7.5.4 Essential information on aerodrome conditions shall be given to every aircraft, except when it is known that the aircraft already has received all or part of the information from other sources. The information shall be given in sufficient time for the aircraft to make proper use of it, and the hazards shall be identified as distinctly as possible.

Note. — “Other sources” include NOTAM, ATIS broadcasts, and the display of suitable signals.

7.5.5 When a not previously notified condition pertaining to the safe use by aircraft of the manoeuvring area is reported to or observed by the controller, the appropriate aerodrome authority shall be informed and operations on that part of the manoeuvring area terminated until otherwise advised by the appropriate aerodrome authority.

7.6 CONTROL OF AERODROME TRAFFIC

7.6.1 General

7.6.1.1 As the view from the flight deck of an aircraft is normally restricted, the controller shall ensure that instructions and information which require the flight crew to employ visual detection, recognition and observation are phrased in a clear, concise and complete manner.

7.6.2 Designated positions of aircraft in the aerodrome traffic and taxi circuits

7.6.2.1 The following positions of aircraft in the traffic and taxi circuits are the positions where the aircraft normally receive aerodrome control tower clearances. The aircraft should be watched closely as they approach these positions so that proper clearances may be issued without delay. Where practicable, all clearances should be issued without waiting for the aircraft to initiate the call.

Position 1. Aircraft initiates call to taxi for departing flight. Runway-in-use information and taxi clearances given.

Position 2. If there is conflicting traffic, the departing aircraft will be held at this position. Engine run-up will, when required, normally be performed here.

Position 3. Take-off clearance is issued here, if not practicable at position 2.

Position 4. Clearance to land is issued here as practicable.

Position 5. Clearance to taxi to apron is issued here.

Position 6. Parking information issued here, if necessary.

Note 1.— Arriving aircraft executing an instrument approach procedure will normally enter the traffic circuit on final except when visual manoeuvring to the landing runway is required.

Note 2.— See Figure 7-1.

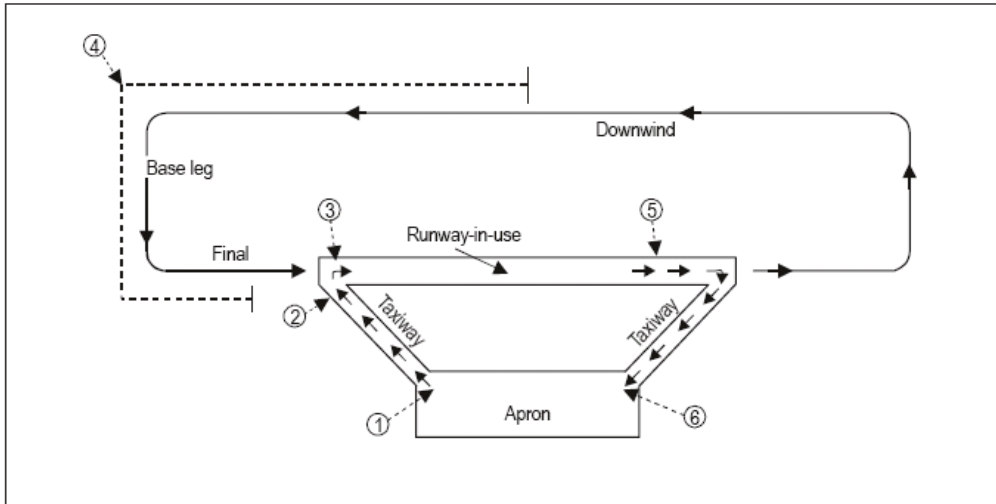

Figure 7-1. Designated positions of aircraft from an aerodrome control tower viewpoint (see 7.5.2).

7.6.3 Traffic on the manoeuvring area

7.6.3.1 CONTROL OF TAXIING AIRCRAFT

7.6.3.1.1 TAXI CLEARANCE

7.6.3.1.1.1 Prior to issuing a taxi clearance, the controller shall determine where the aircraft concerned is parked. Taxi clearances shall contain concise instructions and adequate information so as to assist the flight crew to follow the correct taxi routes, to avoid collision with other aircraft or objects and to minimize the potential for the aircraft inadvertently entering an active runway.

7.6.3.1.1.2 When a taxi clearance contains a taxi limit beyond a runway, it shall contain an explicit clearance to cross or an instruction to hold short of that runway.

7.6.3.1.1.3 The ANSP should whenever practicable publish in AIP Singapore standard taxi routes to be used at an aerodrome. Standard taxi routes should be identified by appropriate designators and should be used in taxi clearances.

7.6.3.1.1.4 Where standard taxi routes have not been published, a taxi route should, wherever possible, be described by use of taxiway and runway designators. Other relevant information, such as an aircraft to follow or give way to, shall also be provided to a taxiing aircraft.

7.6.3.1.2 TAXIING ON A RUNWAY-IN-USE

7.6.3.1.2.1 For the purpose of expediting air traffic, aircraft may be permitted to taxi on the runway-in-use, provided no delay or risk to other aircraft will result. Where control of taxiing aircraft is provided by a ground controller and the control of runway operations by an aerodrome controller, the use of a runway by taxiing aircraft shall be coordinated with and approved by the aerodrome controller. Communication with the aircraft concerned should be transferred from the ground controller to the aerodrome controller prior to the aircraft entering the runway.

7.6.3.1.2.2 If the control tower is unable to determine, either visually or by radar, that a vacating or crossing aircraft has cleared the runway, the aircraft shall be requested to report when it has vacated the runway. The report shall be made when the entire aircraft is beyond the relevant runway-holding position.

7.6.3.1.3 USE OF RUNWAY-HOLDING POSITIONS

7.6.3.1.3.1 Except as provided in 7.5.3.1.3.2 or as prescribed by the ANSP, aircraft shall not be held closer to a runway-in-use than at a runway-holding position.

Note .— Runway-holding position locations in relation to runways are specified in ICAO Annex 14, Volume I, Chapter 5.

7.6.3.1.3.2 Aircraft shall not be permitted to line up and hold on the approach end of a runway-in-use whenever another aircraft is effecting a landing, until the landing aircraft has passed the point of intended holding.

Note .— See Figure 7-2.

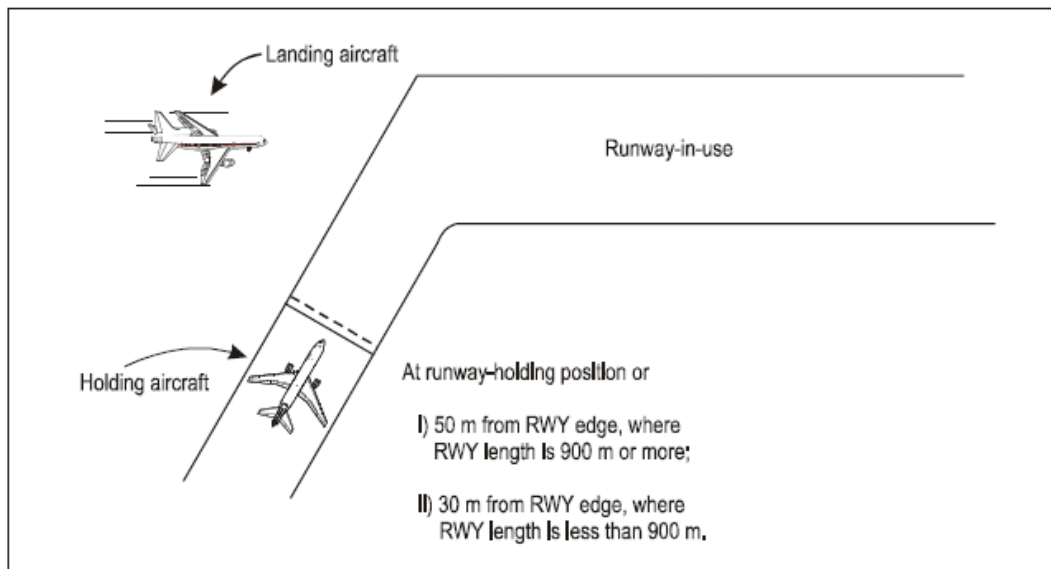

Figure 7-2. Method of holding aircraft (see 7.5.3.1.3.2)

7.6.3.1.4 HELICOPTER TAXIING OPERATIONS

7.6.3.1.4.1 When necessary for a wheeled helicopter or vertical take-off and landing (VTOL) aircraft to taxi on the surface, the following provisions are applicable.

Note.— Ground taxiing uses less fuel than air-taxiing and minimizes air turbulence. However, under certain conditions, such as rough, soft or uneven terrain, it may become necessary to air-taxi for safety considerations. Helicopters with articulating rotors (usually designs with three or more main rotor blades) are subject to “ground resonance” and may, on rare occasions, suddenly lift off the ground to avoid severe damage or destruction.

7.6.3.1.4.2 When it is requested or necessary for a helicopter to proceed at slow speed above the surface, normally below 20 kt and in ground effect, airtaxiing may be authorized.

Note.— Air-taxiing consumes fuel at a high burn rate, and helicopter downwash turbulence (produced in ground effect) increases significantly with larger and heavier helicopters.

7.6.3.1.4.3 Instructions which require small aircraft or helicopters to taxi in close proximity to taxiing helicopters should be avoided and consideration should be given to the effect of turbulence from taxiing helicopters on arriving and departing light aircraft.

7.6.3.1.4.4 A frequency change should not be issued to single-pilot helicopters hovering or air-taxiing. Whenever possible, control instructions from the next ATS unit should be relayed as necessary until the pilot is able to change frequency.

Note.— Most light helicopters are flown by one pilot and require the constant use of both hands and feet to maintain control during low-altitude/low-level flight. Although flight control friction devices assist the pilot, changing frequency near the ground could result in inadvertent ground contact and consequent loss of control.

7.6.3.1.5 LIGHT SIGNALS TO AIRCRAFT

7.6.3.1.5.1 In the case of radio communication failure, the signals given below shall have the meaning indicated therein:

Light	From Aerodrome Control to:	
	Aircraft in flight	Aircraft on the ground
Steady green	Cleared to land	Cleared for take-off
Steady red	Give way to other aircraft and continue circling	Stop
Series of green flashes	Return for landing*	Cleared to taxi
Series of red flashes	Aerodrome unsafe, do not land	Taxi clear of landing area in use
Series of white flashes	Land at this aerodrome and proceed to apron*	Return to starting point on the aerodrome

* Clearances to land and to taxi will be given in due course.

7.6.3.1.5.2 Aircraft will acknowledge in the manner described below:

	<i>When in flight</i>	<i>When on the ground</i>
During the hours of daylight	By rocking the aircraft's wings	By moving the aircraft's ailerons or rudder
During the hours of darkness	By flashing on and off twice the aircraft's landing lights or, if not so equipped, by switching on and off twice its navigation lights.	By flashing on and off twice the aircraft's landing lights or, if not so equipped, by switching on and off twice its navigation lights.

7.6.3.2 CONTROL OF OTHER THAN AIRCRAFT TRAFFIC

7.6.3.2.1 ENTRY TO THE MANOEUVRING AREA

7.6.3.2.1.1 The movement of pedestrians or vehicles on the manoeuvring area shall be subject to authorization by the aerodrome control tower. Persons, including drivers of all vehicles, shall be required to obtain authorization from the aerodrome control tower before entry to the manoeuvring area. Notwithstanding such an authorization, entry to a runway or runway strip or change in the operation authorized shall be subject to a further specific authorization by the aerodrome control tower.

7.6.3.2.2 PRIORITY ON THE MANOEUVRING AREA

7.6.3.2.2.1 All vehicles and pedestrians shall give way to aircraft which are landing, taxiing or taking off, except that emergency vehicles proceeding to the assistance of an aircraft in distress shall be afforded priority over all other surface movement traffic. In the latter case, all movement of surface traffic should, to the extent practicable, be halted until it is determined that the progress of the emergency vehicles will not be impeded.

7.6.3.2.2.2 When an aircraft is landing or taking off, vehicles shall not be permitted to hold closer to the runway-in-use than:

- a) at a taxiway/runway intersection — at a runway-holding position; and
- b) at a location other than a taxiway/runway intersection — at a distance equal to the separation distance of the runway-holding position.

7.6.3.2.3 COMMUNICATION REQUIREMENTS AND VISUAL SIGNALS

7.6.3.2.3.1 At controlled aerodromes all vehicles employed on the manoeuvring area shall be capable of maintaining two-way radio communication with the aerodrome control tower, except when the vehicle is only occasionally used on the manoeuvring area and is:

- a) accompanied by a vehicle with the required communications capability, or
- b) employed in accordance with a pre-arranged plan established with the aerodrome control tower.

7.6.3.2.3.2 When communications by a system of visual signals is deemed to be adequate, or in the case of radio communication failure, the signals given hereunder shall have the meaning indicated therein:

<i>Light signal from aerodrome control</i>	<i>Meaning</i>
Green flashes	Permission to cross landing area or to move onto taxiway
Steady red	Stop
Red flashes	Move off the landing area or taxiway and watch out for aircraft
White flashes	Vacate manoeuvring area in accordance with local instructions

7.6.3.2.3.3 In emergency conditions or if the signals in 7.5.3.2.3.2 are not observed, the signal given hereunder shall be used for runways or taxiways equipped with a lighting system and shall have the meaning indicated therein.

<i>Light signal</i>	<i>Meaning</i>
Flashing runway or taxiway lights	Vacate the runway and observe the tower for light signal

7.6.3.2.3.4 When employed in accordance with a plan pre-arranged with the aerodrome control tower, constructional and maintenance personnel should not normally be required to be capable of maintaining two-way radio communication with the aerodrome control tower.

7.6.4 Ramp Control Service

7.6.4.1 General

7.6.4.1.1 The ANSP must establish the following for the provision of Ramp Control Service (RCS):

- (a) standards, and operating conditions for the provision of RCS;
- (b) clearly defined areas where RCS is provided and specified in the operations manual or other document acceptable to the ANS Regulator; and

(c) a training programme for RCS personnel as specified in paragraph 7.6.4.2; and,

(d) a competency programme for RCS personnel as specified in paragraph 7.6.4.3.

7.6.4.1.2 Paragraph 7.6.4.1.1(c) does not apply to an air traffic controller with a valid licence.

7.6.4.1.3 The ANSP must document its means of compliance to the requirements in this paragraph 7.6.4 in its operations manual or other document which must also contain:

(a) a description of the organisational structure and appointment of key officers of the RCS unit;

(b) clearly defined functions, job descriptions, roles and responsibilities of the operational and supervisory appointments of the RCS unit; and

(c) policies and procedures used for determining its staffing levels to meet its day-to-day RCS operational requirements and contingencies;

7.6.4.1.4 The ANSP must satisfy itself that, prior to implementation, any change to the operational procedures, training and competency framework or manpower deployment is of an acceptable level of safety in accordance with its Safety Management System.

7.6.4.1.5 The ANSP must establish a record-keeping system that covers identification, collection, storage, security, maintenance, access and disposal of records necessary for:

(a) the provision of RCS;

(b) the purpose of reconstruction of events for investigation; and,

(c) for system safety analysis within the Safety Management System.

7.6.4.2 Training Programme

7.6.4.2.1 The ANSP must establish an appropriate training programme for its RCS personnel, and ensure:

(a) its training programme is reviewed periodically such that the training remains relevant;

(b) refresher training is provided to its RCS personnel annually; and,

(c) the implementation of new or amended RCS systems and procedures is preceded by appropriate training and instruction.

7.6.4.2.2 The training programme referred to in paragraph 7.6.4.2.1, including the refresher training aspect, must include, but is not limited to, the handling of aircraft emergencies and operations under conditions with failed and degraded facilities and systems.

7.6.4.3 Competency Programme

7.6.4.3.1 The ANSP must establish a competency programme in the operations manual or document which includes:

- (a) the minimum hours accumulated through the provision of RCS over a period specified by the ANSP to ensure that each RCS personnel continues to possess the required competencies;
- (b) an annual assessment (i.e. proficiency checks) is conducted on each RCS personnel.

7.6.4.3.2 For the purpose of paragraph 7.6.4.3.1, the ANSP must:

- (a) establish a mechanism to monitor the operational performance of its RCS personnel;
- (b) ensure that each of its operational RCS personnel satisfies the competency requirements specified by the ANSP; and
- (c) ensure that any RCS personnel who does not satisfy the competency requirements must undergo appropriate re-training, supervision and assessment programmes specified by the ANSP in the operations manual or document before being deployed for RCS duties.

7.7 CONTROL OF TRAFFIC IN THE TRAFFIC CIRCUIT

7.7.1 General

7.7.1.1 Aircraft in the traffic circuit shall be controlled to provide the separation minima outlined in 7.8.2, 7.9.1 and 7.10 and Chapter 5, Section 5.8, except that:

- a) aircraft in formation are exempted from the separation minima with respect to separation from other aircraft of the same flight;
- b) aircraft operating in different areas or different runways on aerodromes suitable for simultaneous landings or take-offs are exempted from the separation minima;
- c) separation minima shall not apply to aircraft operating under military necessity in accordance with Chapter 16, Section 16.1.

7.7.1.2 Sufficient separation shall be effected between aircraft in flight in the traffic circuit to allow the spacing of arriving and departing aircraft as outlined in 7.9.2, 7.10.1 and 7.11 and Chapter 5, Section 5.8.

7.7.2 Entry of traffic circuit

7.7.2.1 The clearance to enter the traffic circuit should be issued to an aircraft whenever it is desired that the aircraft approach the landing area in accordance with current traffic circuits but traffic conditions do not yet allow a landing clearance to be issued. Depending on the circumstances and traffic conditions, an aircraft may be cleared to join at any position in the traffic circuit.

7.7.2.2 An arriving aircraft executing an instrument approach shall normally be cleared to land straight in unless visual manoeuvring to the landing runway is required.

7.7.3 Priority for landing

7.7.3.1 If an aircraft enters an aerodrome traffic circuit without proper authorization, it shall be permitted to land if its actions indicate that it so desires. If circumstances warrant, aircraft which are in contact with the controller may be instructed by the controller to give way so as to remove as soon as possible the hazard introduced by such unauthorized operation. In no case shall permission to land be withheld indefinitely.

7.7.3.2 In cases of emergency it may be necessary, in the interests of safety, for an aircraft to enter a traffic circuit and effect a landing without proper authorization. Controllers should recognize the possibilities of emergency action and render all assistance possible.

7.7.3.3 Priority shall be given to:

- a) an aircraft which anticipates being compelled to land because of factors affecting the safe operation of the aircraft (engine failure, shortage of fuel, etc.);
- b) hospital aircraft or aircraft carrying any sick or seriously injured persons requiring urgent medical attention;
- c) aircraft engaged in search and rescue operations; and
- d) other aircraft as may be determined by the ANSP.

Note.— An aircraft which has encountered an emergency is handled as outlined in Chapter 15, Section 15.1.

7.8 ORDER OF PRIORITY FOR ARRIVING AND DEPARTING AIRCRAFT

7.8.1 An aircraft landing or in the final stages of an approach to land shall normally have priority over an aircraft intending to depart from the same or an intersecting runway.

7.9 CONTROL OF DEPARTING AIRCRAFT

7.9.1 Departure sequence

7.9.1.1 Departures shall normally be cleared in the order in which they are ready for take-off, except that deviations may be made from this order of priority to facilitate the maximum number of departures with the least average delay. Factors which should be considered in relation to the departure sequence include, *inter alia*:

- a) types of aircraft and their relative performance;
- b) routes to be followed after take-off;
- c) any specified minimum departure interval between take-offs;
- d) need to apply wake turbulence separation minima;
- e) aircraft which should be afforded priority; and
- f) aircraft subject to ATFM requirements.

Note 1.— See also Chapter 6, 6.3.3.

Note 2.— For aircraft subject to ATFM requirements, it is the responsibility of the pilot and the operator to ensure that the aircraft is ready to taxi in time to meet any required departure time, bearing in mind that once a departure sequence is established on the taxiway system, it can be difficult, and sometimes impossible, to change the order.

7.9.2 Separation of departing aircraft

7.9.2.1 Except as provided in Chapter 5, Section 5.8, a departing aircraft will not normally be permitted to commence take-off until the preceding departing aircraft has crossed the end of the runway-in-use or has started a turn or until all preceding landing aircraft are clear of the runway-in-use.

Note 1.— See Figure 7-3.

Note 2.— Wake turbulence categories and time-based wake turbulence longitudinal separation minima are contained in Chapter 4, Section 4.9 and Chapter 5, Section 5.8, respectively. Distance-based wake turbulence separation minima are contained in Chapter 8, Section 8.7.

Note 3.— See 7.6.3.1.2.2.

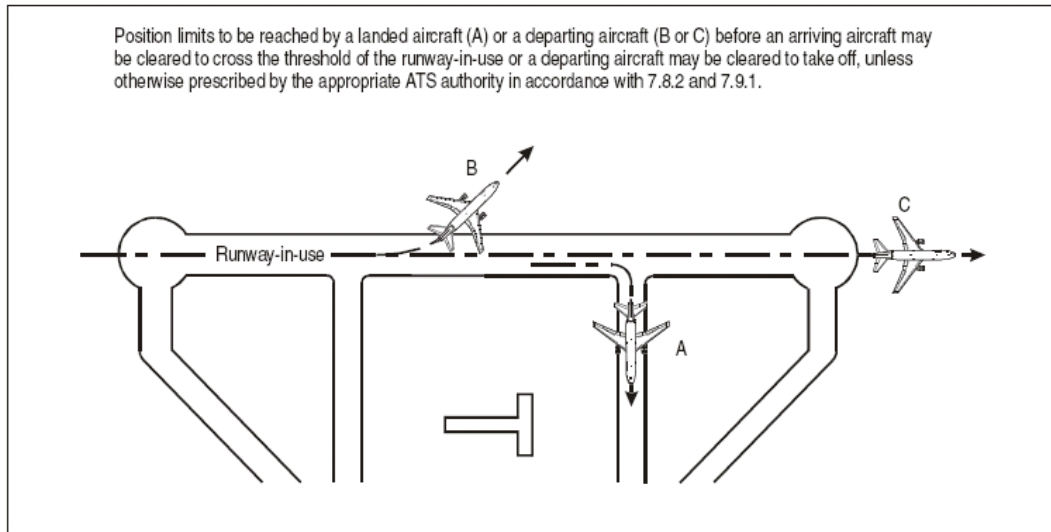

Figure 7-3. Separation between departing and arriving aircraft (see 7.8.2 and 7.9.1)

7.9.3 Take-off clearance

7.9.3.1 Take-off clearance may be issued to an aircraft when there is reasonable assurance that the separation in 7.9.2 will exist when the aircraft commences take-off.

7.9.3.2 When an ATC clearance is required prior to takeoff, the take-off clearance shall not be issued until the ATC clearance has been transmitted to and acknowledged by the aircraft concerned. The ATC clearance shall be forwarded to the aerodrome control tower with the least possible delay after receipt of a request made by the tower or prior to such request if practicable.

7.9.3.3 Subject to 7.9.3.2, the take-off clearance shall be issued when the aircraft is ready for take-off and at or approaching the departure runway, and the traffic situation permits. To reduce the potential for misunderstanding, the take-off clearance shall include the designator of the departure runway.

7.9.3.3A The expression TAKE-OFF must only be used in radiotelephony when an aircraft is cleared for take-off or when cancelling a take-off clearance.

7.9.3.4 In the interest of expediting traffic, a clearance for immediate take-off may be issued to an aircraft before it enters the runway. On acceptance of such clearance the aircraft must taxi out to the runway and take off in one continuous movement.

7.10 CONTROL OF ARRIVING AIRCRAFT

7.10.1 Separation of landing aircraft and preceding landing and departing aircraft using the same runway

7.10.1.1 Except as provided in 7.11 and Chapter 5, Section 5.8, a landing aircraft will not normally be permitted to cross the runway threshold on its final approach until the preceding departing aircraft has crossed the end of the runway-in-use, or has started a turn, or until all preceding landing aircraft are clear of the runway-in-use.

Note 1.— See Figure 7-3.

Note 2.— Wake turbulence categories of aircraft and longitudinal separation minima are contained in Chapter 4, Section 4.9 and Chapter 5, Section 5.8, respectively.

Note 3.— See 7.6.3.1.2.2.

7.10.2 Clearance to land

7.10.2.1 An aircraft may be cleared to land when there is reasonable assurance that the separation in 7.9.1, or prescribed in accordance with 7.10 will exist when the aircraft crosses the runway threshold, provided that a clearance to land shall not be issued until a preceding landing aircraft has crossed the runway threshold. To reduce the potential for misunderstanding, the landing clearance shall include the designator of the landing runway.

7.10.3 Landing and roll-out manoeuvres

7.10.3.1 When necessary or desirable in order to expedite traffic, a landing aircraft may be requested to:

- a) hold short of an intersecting runway after landing;
- b) land beyond the touchdown zone of the runway;
- c) vacate the runway at a specified exit taxiway;
- d) expedite vacating the runway.

7.10.3.2 In requesting a landing aircraft to perform a specific landing and/or roll-out manoeuvre, the type of aircraft, runway length, location of exit taxiways, reported braking action on runway and taxiway, and prevailing meteorological conditions shall be considered. A HEAVY aircraft shall not be requested to land beyond the touchdown zone of a runway.

7.10.3.3 If the pilot-in-command considers that he or she is unable to comply with the requested operation, the controller shall be advised without delay.

7.10.3.4 When necessary or desirable, e.g. due to low visibility conditions, a landing or a taxiing aircraft may be instructed to report when a runway has been vacated. The report shall be made when the entire aircraft is beyond the relevant runway-holding position.

7.11 REDUCED RUNWAY SEPARATION MINIMA BETWEEN AIRCRAFT USING THE SAME RUNWAY

Note: This section is reserved.

7.12 PROCEDURES FOR LOW VISIBILITY OPERATIONS

7.12.1 Control of aerodrome surface traffic in conditions of low visibility

Note.— These procedures apply whenever conditions are such that all or part of the manoeuvring area cannot be visually monitored from the control tower. Additional requirements which apply when category II/III approaches are being conducted are specified in Section 7.12.2.

7.12.1.1 When there is a requirement for traffic to operate on the manoeuvring area in conditions of visibility which prevent the aerodrome control tower from applying visual separation between aircraft, and between aircraft and vehicles, the following shall apply:

7.12.1.2 At the intersection of taxiways, an aircraft or vehicle on a taxiway shall not be permitted to hold closer to the other taxiway than the holding position limit defined by a clearance bar, stop bar or taxiway intersection marking according to the specifications in ICAO Annex 14, Volume I, Chapter 5.

7.12.1.1.2 The longitudinal separation on taxiways shall be as specified for each particular aerodrome by the ANSP. This separation shall take into account the characteristics of the aids available for surveillance and control of ground traffic, the complexity of the aerodrome layout and the characteristics of the aircraft using the aerodrome.

Note.— The Manual of Surface Movement Guidance and Control Systems (SMGCS) (Doc 9476) provides guidance on surface movement guidance and control components and procedures for low visibility operations.

7.12.2 Procedures for control of aerodrome traffic when category II/III approaches are in use

7.12.2.1 The ANSP shall establish provisions applicable to the start and continuation of precision approach category II/III operations as well as departure operations in RVR conditions less than a value of 550 m.

7.12.3 Low visibility operations shall be initiated by or through the aerodrome control tower.

7.12.4 The aerodrome control tower shall inform the approach control unit concerned when procedures for precision approach category II/III and low visibility operations will be applied and also when such procedures are no longer in force.

7.12.5 Provisions regarding low visibility operations should specify:

- a) the RVR value(s) at which the low visibility operations procedures shall be implemented;
- b) the minimum ILS/MLS equipment requirements for category II/III operations;
- c) other facilities and aids required for category II/III operations, including aeronautical ground lights, which shall be monitored for normal operation;
- d) the criteria for and the circumstances under which downgrading of the ILS equipment from category II/III operations capability shall be made;
- e) the requirement to report any relevant equipment failure and degradation, without delay, to the flight crews concerned, the approach control unit, and any other appropriate organization;
- f) special procedures for the control of traffic on the manoeuvring area, including:
 - 1) the runway-holding positions to be used;
 - 2) the minimum distance between an arriving and a departing aircraft to ensure protection of the sensitive and critical areas;
 - 3) procedures to verify that aircraft and vehicles have vacated the runway;
 - 4) procedures applicable to the separation of aircraft and vehicles;
- g) applicable spacing between successive approaching aircraft;
- h) action(s) to be taken in the event low visibility operations need to be discontinued, e.g. due to equipment failures; and
- i) any other relevant procedures or requirements.

Note.— Further information regarding the requirements for low visibility operations can be found in the Air Traffic Services Planning Manual (Doc 9426) and the All Weather Operations Manual (Doc9365).

7.12.6 The aerodrome control tower shall, prior to a period of application of low visibility procedures, establish a record of vehicles and persons currently on the manoeuvring area and maintain this record during the period of application of these procedures to assist in assuring the safety of operations on that area.

Note.— See also 7.6.3.2.

7.13 SUSPENSION OF VISUAL FLIGHT RULES OPERATIONS

7.13.1 Any or all VFR operations on and in the vicinity of an aerodrome may be suspended by any of the following units, persons or authorities whenever safety requires such action:

- a) the approach control unit or the appropriate ACC;
- b) the aerodrome control tower;
- c) the appropriate ANSP.

7.13.2 All such suspensions of VFR operations shall be accomplished through or notified to the aerodrome control tower.

7.13.3 The following procedures shall be observed by the aerodrome control tower whenever VFR operations are suspended:

- a) hold all VFR departures;
- b) recall all local flights operating under VFR or obtain approval for special VFR operations;
- c) notify the approach control unit or ACC as appropriate of the action taken;
- d) notify all operators, or their designated representatives, of the reason for taking such action, if necessary or requested.

Note.— The specified VFR minima are contained in Annex 2, Chapter 4.

7.14 AUTHORIZATION OF SPECIAL VFR FLIGHTS

7.14.1 When traffic conditions permit, special VFR flights may be authorized subject to the approval of the unit providing approach control service and the provisions of 7.14.1.3.

7.14.1.1 Requests for such authorization shall be handle individually.

7.14.1.2 Separation shall be effected between all IFR flights and special VFR flights in accordance with separation minima in Chapters 5 and 6 and, when so prescribed by the ANSP, between all special VFR flights in accordance with separation minima prescribed by that unit.

7.14.1.3 When the ground visibility is not less than 1 500 m, special VFR flights may be authorized to: enter a control zone for the purpose of landing, take off and depart from a control zone, cross a control zone or operate locally within a control zone.

Note.— Requirements for two-way communications between controlled flights and the appropriate air traffic control unit are contained in ICAO Annex 2, 3.6.5.

7.15 AERONAUTICAL GROUND LIGHTS

7.15.1 Operation

Note.— The procedures in this Section apply to all aerodromes, whether or not aerodrome control service is provided. In addition, the procedures in 7.15.2.1 apply to all aeronautical ground lights, whether or not they are on or in the vicinity of an aerodrome.

7.15.2 General

7.15.2.1 All aeronautical ground lights shall be operated, except as provided in 7.15.2.2 and 7.15.3:

- a) continuously during the hours of darkness or during the time the centre of the sun's disc is more than 6 degrees below the horizon, whichever requires the longer period of operation, unless otherwise provided hereafter or otherwise required for the control of air traffic;
- b) at any other time when their use, based on meteorological conditions, is considered desirable for the safety of air traffic.

7.15.2.2 Lights on and in the vicinity of aerodromes that are not intended for en-route navigation purposes may be turned off, subject to further provisions hereafter, if no likelihood of either regular or emergency operation exists, provided that they can be again brought into operation at least one hour before the expected arrival of an aircraft.

7.15.2.3 At aerodromes equipped with lights of variable intensity a table of intensity settings, based on conditions of visibility and ambient light, should be provided for the guidance of air traffic controllers in effecting adjustment of these lights to suit the prevailing conditions. When so requested by an aircraft, further adjustment of the intensity shall be made whenever possible.

7.15.3 Approach lighting

Note.— Approach lighting includes such lights as simple approach lighting systems, precision approach lighting systems, visual approach slope indicator systems, circling guidance lights, approach light beacons and runway alignment indicators.

7.15.3.1 In addition to 7.14.2.1 approach lighting shall also be operated:

- a) by day when requested by an approaching aircraft;
- b) when the associated runway lighting is operated.

7.15.3.2 The lights of a visual approach slope indicator system shall be operated during the hours of daylight as well as of darkness and irrespective of the visibility conditions when the associated runway is being used.

7.15.4 Runway lighting

Note.— Runway lighting includes such lights as edge, threshold, centre line, end, touchdown zone and wing bar lights.

7.15.4.1 Runway lighting shall not be operated if that runway is not in use for landing, take-off or taxiing purposes, unless required for runway inspections or maintenance.

7.15.4.2 If runway lighting is not operated continuously, lighting following a take-off shall be provided as specified below:

- a) at aerodromes where air traffic control service is provided and where lights are centrally controlled, the lights of one runway shall remain lighted after take-off as long as is considered necessary for the return of the aircraft due to an emergency occurring during or immediately after take-off;
- b) at aerodromes without air traffic control service or without centrally controlled lights, the lights of one runway shall remain lighted until such time as would normally be required to reactivate the lights in the likelihood of the departing aircraft returning for an emergency landing, and in any case not less than fifteen minutes after take-off.

Note.— Where obstacle lighting is operated simultaneously with runway lighting as provided in 7.15.8.1, particular care should be taken to ensure that it is not turned off until no longer required by the aircraft.

7.15.5 Stopway lighting

7.15.5.1 Stopway lights shall be operated whenever the associated runway lights are operated.

7.15.6 Taxiway lighting

Note.— Taxiway lighting includes such lights as edge lights, centre line lights, stop bars and clearance bars.

7.15.6.1 Where required to provide taxi guidance, taxiway lighting shall be turned on in such order that a continuous indication of the taxi path is presented to taxiing aircraft. Taxiway lighting or any portion thereof may be turned off when no longer needed.

7.15.7 Stop bars

7.15.7.1 Stop bars shall be switched on to indicate that all traffic shall stop and switched off to indicate that traffic may proceed.

Note.— Stop bars are located across taxiways at the point where it is desired that traffic stop, and consist of lights, showing red, spaced across the taxiway.

7.15.8 Obstacle lighting

Note.— Obstacle lighting includes such lights as obstacle and unserviceability lights and hazard beacons.

7.15.8.1 Obstacle lighting associated with the approach to or departure from a runway or channel, where the obstacle does not project through the inner horizontal surface, as described in ICAO Annex 14, Volume I, Chapter 6, may be turned off and on simultaneously with the runway or channel lights.

7.15.8.2 Unserviceability lights may not be turned off as permitted under 7.14.2.2 while the aerodrome is open.

7.15.9 Monitoring of visual aids

7.15.9.1 Aerodrome controllers shall make use of automatic monitoring facilities, when provided, to ascertain whether the lighting is in good order and functioning according to selection.

7.15.9.2 In the absence of an automatic monitoring system or to supplement such a system, the aerodrome controller shall visually observe such lighting as can be seen from the aerodrome control tower and use information from other sources such as visual inspections or reports from aircraft to maintain awareness of the operational status of the visual aids.

7.15.9.3 On receipt of information indicating a lighting fault, the aerodrome controller shall take such action as is warranted to safeguard any affected aircraft or vehicles, and initiate action to have the fault rectified.

7.16 DESIGNATION OF HOT SPOT(S)

7.16.1 The aerodrome operator shall designate, whenever necessary, a location or several locations on the movement area of the aerodrome as hot spot(s). The hot spot(s) shall be charted in accordance with ICAO Annex 4, 13.6, 14.6, 15.6 and Appendix 2.

Note.— Guidance material related to hot spots is contained in the Manual on the Prevention of Runway Incursions (Doc 9870).

CHAPTER 8

ATS SURVEILLANCE SERVICES

Note.— ADS-contract (ADS-C), at this time used wholly to provide procedural separation, is covered in Chapter 13.

8.1 ATS SURVEILLANCE SYSTEMS CAPABILITIES

8.1.1 ATS surveillance systems used in the provision of air traffic services shall have a very high level of reliability, availability and integrity. The possibility of system failures or significant system degradations which may cause complete or partial interruptions of service shall be very remote. Back-up facilities shall be provided.

Note 1.— An ATS surveillance system will normally consist of a number of integrated elements, including sensor(s), data transmission links, data-processing systems and situation displays.

Note 2.— Guidance material pertaining to use of radar and to system performance is contained in the Manual on Testing of Radio Navigation Aids (Doc 8071), the Manual on the Secondary Surveillance Radar (SSR) Systems (Doc 9684) and the Air Traffic Services Planning Manual (Doc 9426).

Note 3.— Guidance material pertaining to use of ADS-B and MLAT systems and their system performance is contained in Cir 326.

Note 4. — Functional and performance requirements pertaining to ATS surveillance systems are contained in Annex 10 — Aeronautical Telecommunications, Volume IV — Surveillance and Collision Avoidance Systems.

8.1.2 ATS surveillance systems should have the capability to receive, process and display, in an integrated manner, data from all the connected sources.

8.1.3 ATS surveillance systems should be capable of integration with other automated systems used in the provision of ATS, and should provide for an appropriate level of automation with the objectives of improving the accuracy and timeliness of data displayed to the controller and reducing controller workload and the need for verbal coordination between adjacent control positions and ATC units.

8.1.4 ATS surveillance systems should provide for the display of safety-related alerts and warnings, including conflict alert, minimum safe altitude warning, conflict prediction and unintentionally duplicated SSR codes and aircraft identification.

8.1.5 The ANSP should, to the extent possible, facilitate the sharing of information derived from ATS surveillance systems in order to extend and improve surveillance coverage in adjacent control areas.

8.1.6 The ANSP should, to the extent possible, provide for the automated exchange of coordination data relevant to aircraft being provided with ATS surveillance services, and establish automated coordination procedures.

8.1.7 ATS surveillance systems, such as primary surveillance radar (PSR), secondary surveillance radar (SSR), ADS-B and MLAT systems may be used either alone or in combination in the provision of air traffic services, including in the provision of separation between aircraft, provided:

- a) reliable coverage exists in the area; and
- b) the probability of detection, the accuracy and the integrity of the ATS surveillance system(s) are satisfactory; and
- c) in the case of ADS-B, the availability of data from participating aircraft is adequate.

8.1.8 PSR systems should be used in circumstances where other surveillance systems alone would not meet the air traffic services requirements.

8.1.9 SSR systems, especially those utilising monopulse techniques or having Mode S capability, or MLAT may be used alone, including in the provision of separation between aircraft, provided:

- a) the carriage of SSR transponders is mandatory within the area; and
- b) identification is established and maintained.

8.1.10 ADS-B shall only be used for the provision of air traffic control service provided the quality of the information contained in the ADS-B message exceeds the values specified by the ANSP.

8.1.11 ADS-B may be used alone, including in the provision of separation between aircraft, provided:

- a) identification of ADS-B-equipped aircraft is established and maintained;
- b) the data integrity measure in the ADS-B message is adequate to support the separation minimum;
- c) there is no requirement for detection of aircraft not transmitting ADS-B; and
- d) there is no requirement for determination of aircraft position independent of the position-determining elements of the aircraft navigation system.

8.1.12 The provision of ATS surveillance services shall be limited to specified areas of coverage and shall be subject to such other limitations as have been specified by the ANSP. Adequate information on the operating methods used shall be

published in aeronautical information publications, as well as operating practices and/or equipment limitations having direct effects on the operation of the air traffic services.

Note.— The ANSP will provide information on the area or areas where PSR, SSR, ADS-B and MLAT systems are in use as well as ATS surveillance services and procedures in accordance with ICAO Annex 15, 4.1.1 and Appendix 1.

8.1.13 The provision of ATS surveillance services shall be limited when position data quality degrades below a level specified by the ANSP.

8.1.14 Where PSR and SSR are required to be used in combination, SSR alone may be used in the event of PSR failure to provide separation between identified transponder-equipped aircraft, provided the accuracy of the SSR position indications has been verified by monitor equipment or other means.

8.2 SITUATION DISPLAY

8.2.1 A situation display providing surveillance information to the controller shall, as a minimum, include position indications, map information required to provide ATS surveillance services and, where available, information concerning the identity of the aircraft and the aircraft level.

8.2.2 The ATS surveillance system shall provide for a continuously updated presentation of surveillance information, including position indications.

8.2.3 Position indications may be displayed as:

- a) individual position symbols, e.g. PSR, SSR, ADS-B or MLAT symbols, or combined symbols;
- b) PSR blips; and
- c) SSR responses.

8.2.4 When applicable, distinct symbols should be used for presentation of:

- a) unintentionally duplicated SSR codes and/or aircraft identification that are unintentionally duplicated;
- b) predicted positions for a non-updated track; and
- c) plot and track data.

8.2.5 Where surveillance data quality degrades such that services need to be limited, symbology or other means shall be used to provide the controller with an indication of the condition.

8.2.6 Reserved SSR codes, including 7500, 7600 and 7700, operation of IDENT, ADS-B emergency and/or urgency modes, safety-related alerts and warnings as well as information related to automated coordination shall be presented in a clear and distinct manner, providing for ease of recognition.

8.2.7 Labels associated with displayed targets should be used to provide, in alphanumeric form, relevant information derived from the means of surveillance and, where necessary, the flight data processing system.

8.2.8 Labels shall, as a minimum, include information relating to the identity of the aircraft, e.g. SSR code or aircraft identification and, if available, pressure-altitude-derived level information. This information may be obtained from SSR Mode A, SSR Mode C, SSR Mode S and/or ADS-B.

8.2.9 Labels shall be associated with their position indications in a manner precluding erroneous identification by or confusion on the part of the controller. All label information shall be presented in a clear and concise manner.

8.3 COMMUNICATIONS

8.3.1 The level of reliability and availability of communications systems shall be such that the possibility of system failures or significant degradations is very remote. Adequate backup facilities shall be provided.

Note.— Guidance material and information pertaining to system reliability and availability are contained in ICAO Annex 10, Volume I and the Air Traffic Services Planning Manual (Doc 9426).

8.3.2 Direct pilot-controller communications shall be established prior to the provision of ATS surveillance services, unless special circumstances such as emergencies dictate otherwise.

8.4 PROVISION OF ATS SURVEILLANCE SERVICES

8.4.1 Information derived from ATS surveillance systems, including safety-related alerts and warnings such as conflict alert and minimum safe altitude warning, should be used to the extent possible in the provision of air traffic control service in order to improve capacity and efficiency as well as to enhance safety.

8.4.2 The number of aircraft simultaneously provided with ATS surveillance services shall not exceed that which can safely be handled under the prevailing circumstances, taking into account:

- a) the structural complexity of the control area or sector concerned;
- b) the functions to be performed within the control area or sector concerned;

- c) assessments of controller workloads, taking into account different aircraft capabilities, and sector capacity; and
- d) the degree of technical reliability and availability of the primary and backup communications, navigation and surveillance systems, both in the aircraft and on the ground.

8.5 USE OF SSR TRANSPONDERS AND ADS-B TRANSMITTERS

8.5.1 General

8.5.1.1 To ensure the safe and efficient use of ATS surveillance services, pilots and controllers shall strictly adhere to published operating procedures and standard radiotelephony phraseology shall be used. The correct setting of transponder codes and/or aircraft identification shall be ensured at all times.

8.5.2 SSR Code management

8.5.2.1 Codes 7700, 7600 and 7500 shall be reserved internationally for use by pilots encountering a state of emergency, Radio-communication failure or unlawful interference, respectively.

8.5.2.2 SSR Codes are to be allocated and assigned in accordance with the following principles.

8.5.2.3 Codes should be allocated to States or areas in accordance with regional air navigation agreements, taking into account overlapping radar coverage over adjacent airspaces.

8.5.2.4 The ANSP shall establish a plan and procedures for the allocation of codes to ATS units.

8.5.2.5 The plan and procedures should be compatible with those practised in adjacent States.

8.5.2.6 The allocation of a code should preclude the use of this code for any other function within the area of coverage of the same SSR for a prescribed time period.

8.5.2.7 To reduce pilot and controller workload and the need for controller/pilot communications, the number of code changes required of the pilot should be kept to the minimum.

8.5.2.8 Codes shall be assigned to aircraft in accordance with the plan and procedures laid down by the ANSP.

8.5.2.9 Where there is a need for individual aircraft identification, each aircraft shall be assigned a discrete code which should, whenever possible, be retained throughout the flight.

8.5.2.10 Except for aircraft in a state of emergency, or during communication failure or unlawful interference situations, and unless otherwise agreed between a transferring and an accepting ATC unit, the transferring unit shall assign Code A2000 to a controlled flight prior to transfer of communications.

8.5.2.11 SSR Codes shall be reserved, as necessary, for exclusive use by medical aircraft operating in areas of international armed conflict. Such SSR Codes shall be allocated by ICAO through its Regional Offices.

Note.— The term “medical aircraft” refers to aircraft protected under the Geneva Conventions of 1949 and under the Protocol Additional to the Geneva Conventions of 12 August 1949, and relating to the protection of victims of international armed conflicts (Protocol I).

8.5.3 Operation of SSR transponders

Note.— SSR transponder operating procedures are contained in Procedures for Air Navigation Services — Aircraft Operations (PANS-OPS, Doc 8168), Volume I, Part VIII, Section 3.

8.5.3.1 When it is observed that the Mode A code shown on the situation display is different to what has been assigned to the aircraft, the pilot shall be requested to confirm the code selected and, if the situation warrants (e.g. not being a case of unlawful interference), to reselect the correct code.

8.5.3.2 If the discrepancy between assigned and displayed Mode A codes still persists, the pilot may be requested to stop the operation of the aircraft’s transponder. The next control position and any other affected unit using SSR and/or MLAT in the provision of ATS shall be informed accordingly.

8.5.3.3 Aircraft equipped with Mode S having an aircraft identification feature shall transmit the aircraft identification as specified in Item 7 of the ICAO flight plan or, when no flight plan has been filed, the aircraft registration.

Note.— All Mode S-equipped aircraft engaged in international civil aviation are required to have an aircraft identification feature (ICAO Annex 10, Volume IV, Chapter 2, 2.1.5.2, refers).

8.5.3.4 Whenever it is observed on the situation display that the aircraft identification transmitted by a Mode S-equipped aircraft is different from that expected from the aircraft, the pilot shall be requested to confirm and, if necessary, re-enter the correct aircraft identification.

8.5.3.5 If, following confirmation by the pilot that the correct aircraft identification has been set on the Mode S identification feature, the discrepancy continues to exist, the following actions shall be taken by the controller:

- a) inform the pilot of the persistent discrepancy;
- b) where possible, correct the label showing the aircraft identification on the situation display; and
- c) notify the erroneous aircraft identification transmitted by the aircraft to the next control position and any other interested unit using Mode S for identification purposes.

8.5.4 Operation of ADS-B transmitters

Note 1.— To indicate that it is in a state of emergency or to transmit other urgent information, an aircraft equipped with ADS-B might operate the emergency and/or urgency mode as follows:

- a) emergency;*
- b) communication failure;*
- c) unlawful interference;*
- d) minimum fuel; and/or*
- e) medical.*

Note 2. — Some aircraft equipped with first generation ADS-B avionics do not have the capability described in Note 1 above and only have the capability to transmit a general emergency alert regardless of the code selected by the pilot.

8.5.4.1 Aircraft equipped with ADS-B having an aircraft identification feature shall transmit the aircraft identification as specified in Item 7 of the ICAO flight plan or, when no flight plan has been filed, the aircraft registration.

8.5.4.2 Whenever it is observed on the situation display that the aircraft identification transmitted by an ADS-B-equipped aircraft is different from that expected from the aircraft, the pilot shall be requested to confirm and, if necessary, re-enter the correct aircraft identification.

8.5.4.3 If, following confirmation by the pilot that the correct aircraft identification has been set on the ADS-B identification feature, the discrepancy continues to exist, the following actions shall be taken by the controller:

- a) inform the pilot of the persistent discrepancy;
- b) where possible, correct the label showing the aircraft identification on the situation display; and
- c) notify the next control position and any other unit concerned of the erroneous aircraft identification transmitted by the aircraft.

8.5.5 Level information based on the use of pressure-altitude information

8.5.5.1 VERIFICATION OF LEVEL INFORMATION

8.5.5.1.2 Verification of pressure-altitude-derived level information displayed to the controller shall be effected at least once by each suitably equipped ATC unit on initial contact with the aircraft concerned or, if this is not feasible, as soon as possible thereafter. The verification shall be effected by simultaneous comparison with altimeter-derived level information received from the same aircraft by radiotelephony. The pilot of the aircraft whose pressure-altitude-derived level information is within the approved tolerance value need not be advised of such verification. Geometric height information shall not be used to determine if altitude differences exist.

8.5.5.1.3 If the displayed level information is not within the approved tolerance value or when a discrepancy in excess of the approved tolerance value is detected subsequent to verification, the pilot shall be advised accordingly and requested to check the pressure setting and confirm the aircraft's level.

8.5.5.1.4 If, following confirmation of the correct pressure setting the discrepancy continues to exist, the following action should be taken according to circumstances:

- a) request the pilot to stop Mode C or ADS-B altitude data transmission, provided this does not cause the loss of position and identity information, and notify the next control positions or ATC unit concerned with the aircraft of the action taken; or
- b) inform the pilot of the discrepancy and request that the relevant operation continue in order to prevent loss of position and identity information of the aircraft and, when authorized by the ANSP, override the label-displayed level information with the reported level. Notify the next control position or ATC unit concerned with the aircraft of the action taken.

8.5.5.2 DETERMINATION OF LEVEL OCCUPANCY

8.5.5.2.1 The criterion which shall be used to determine that a specific level is occupied by an aircraft shall be ± 60 m (± 200 ft) in RVSM airspace. In other airspace, it shall be ± 90 m (± 300 ft), except that the ANSP may specify a smaller criterion, but not less than ± 60 m (± 200 ft), if this is found to be more practical.

Note.— For a brief explanation of the considerations underlying this value, see the Air Traffic Services Planning Manual (Doc 9426).

8.5.5.2.2 *Aircraft maintaining a level.* An aircraft is considered to be maintaining its assigned level as long as the pressure-altitude-derived level information indicates that it is within the appropriate tolerances of the assigned level, as specified in 8.5.5.2.1.

8.5.5.2.3 *Aircraft vacating a level.* An aircraft cleared to leave a level is considered to have commenced its manoeuvre and vacated the previously occupied level when the pressure-altitude-derived level information indicates a change of more than 90 m (300 ft) in the anticipated direction from its previously assigned level.

8.5.5.2.4 *Aircraft passing a level in climb or descent.* An aircraft in climb or descent is considered to have crossed a level when the pressure-altitude-derived level information indicates that it has passed this level in the required direction by more than 90 m (300 ft).

8.5.5.2.5 *Aircraft reaching a level.* An aircraft is considered to have reached the level to which it has been cleared when the elapsed time of three display updates, three sensor updates or 15 seconds, whichever is the greater, has passed since the pressure-altitude-derived level information has indicated that it is within the appropriate tolerances of the assigned level, as specified in 8.5.5.2.1.

8.5.5.2.6 Intervention by a controller shall only be required if differences in level information between that displayed to the controller and that used for control purposes are in excess of the values stated above.

8.6 GENERAL PROCEDURES

8.6.1 Performance checks

8.6.1.1 The controller shall adjust the situation display(s) and carry out adequate checks on the accuracy thereof, in accordance with the technical instructions prescribed by the appropriate authority for the radar equipment concerned.

8.6.1.2 The controller shall be satisfied that the available functional capabilities of the ATS surveillance system as well as the information presented on the situation display(s) is adequate for the functions to be performed.

8.6.1.3 The controller shall report, in accordance with local procedures, any fault in the equipment, or any incident requiring investigation, or any circumstances which make it difficult or impractical to provide ATS surveillance services.

8.6.2 Identification of aircraft

8.6.2.1 ESTABLISHMENT OF IDENTIFICATION

8.6.2.1.1 Before providing ATS surveillance service to an aircraft, identification shall be established and the pilot informed. Thereafter, identification shall be maintained until termination of the ATS surveillance service.

8.6.2.1.2 If identification is subsequently lost, the pilot shall be informed accordingly and, when applicable, appropriate instructions issued.

8.6.2.1.3 Identification shall be established by at least one of the methods specified in 8.6.2.2, 8.6.2.3, 8.6.2.4 and 8.6.2.5.

8.6.2.2 ADS-B IDENTIFICATION PROCEDURES

8.6.2.2.1 Where ADS-B is used for identification, aircraft may be identified by one or more of the following procedures:

- a) direct recognition of the aircraft identification in an ADS-B label;
- b) transfer of ADS-B identification (see 8.6.3); and
- c) observation of compliance with an instruction to TRANSMIT ADS-B IDENT.

Note 1. — Some aircraft equipped with first generation ADS-B avionics do not have the capability of squawking IDENT while the emergency and/or urgency mode is selected.

Note 2.— In automated systems, the “IDENT” feature may be presented in different ways, e.g. as a flashing of all or part of the position indication and associated label.

8.6.2.3 SSR and/or MLAT IDENTIFICATION PROCEDURES

8.6.2.3.1 Where SSR and/or MLAT is used for identification, aircraft may be identified by one or more of the following procedures:

- a) recognition of the aircraft identification in a SSR and/or MLAT label;

Note.— The use of this procedure requires that the code/call sign correlation is achieved successfully, taking into account the Note following b) below.

- b) recognition of an assigned discrete code, the setting of which has been verified, in a SSR and/or MLAT label; and

Note.— The use of this procedure requires a system of code assignment which ensures that each aircraft in a given portion of airspace is assigned a discrete code (see 8.5.2.2.7).

- c) direct recognition of the aircraft identification of a Mode S-equipped aircraft in a SSR and/or MLAT label;

Note.— The aircraft identification feature available in Mode S transponders provides the means to identify directly individual aircraft on radar displays and thus offers the potential to eliminate ultimately the recourse to Mode A discrete codes for individual identification. This elimination will only be achieved in a progressive manner depending on the state of deployment of suitable ground and airborne installations.

- d) by transfer of radar identification (see 8.6.3);
- e) observation of compliance with an instruction to set a specific code;
- f) observation of compliance with an instruction to squawk IDENT;

Note 1.— In automated radar systems, the “IDENT” feature may be presented in different ways, e.g. as a flashing of all or part of the radar position and associated data block.

Note 2.— Garbling of transponder replies may produce “IDENT”-type indications. Nearly simultaneous “IDENT” transmissions within the same area may give rise to errors in identification.

8.6.2.3.2 When a discrete code has been assigned to an aircraft, a check shall be made at the earliest opportunity to ensure that the code set by the pilot is identical to that assigned for the flight. Only after this check has been made shall the discrete code be used as a basis for identification.

8.6.2.4 PSR IDENTIFICATION PROCEDURES

8.6.2.4.1 Where PSR is used for identification, aircraft may be identified by one or more of the following procedures:

- a) by correlating a particular radar position indication with an aircraft reporting its position over, or as bearing and distance from, a point displayed on the radar map, and by ascertaining that the track of the particular radar position is consistent with the aircraft path or reported heading;

Note 1.— Caution must be exercised when employing this method since a position reported in relation to a point may not coincide precisely with the radar position indication of the aircraft on the radar map. The ANSP may, therefore, prescribe additional conditions for the application of this method, e.g.:

- i) a level or levels above which this method may not be applied in respect of specified navigation aids; or*
- ii) a distance from the radar site beyond which this method may not be applied.*

Note 2.— The term “a point” refers to a geographical point suitable for the purposes of radar identification. It is normally a reporting point defined by reference to a radio navigation aid or aids.

- b) by correlating an observed radar position indication with an aircraft which is known to have just departed, provided that the identification is established within 2 km (1 NM) from the end of the runway used. Particular care should be taken to avoid confusion with aircraft holding over or overflying the aerodrome, or with aircraft departing from or making a missed approach over adjacent runways;

- c) by transfer of identification (see 8.6.3);

- d) by ascertaining the aircraft heading, if circumstances require, and following a period of track observation:

- instructing the pilot to execute one or more changes of heading of 30 degrees or more and correlating the movements of one particular radar position indication with the aircraft’s acknowledged execution of the instructions given; or
- correlating the movements of a particular radar position indication with manoeuvres currently executed by an aircraft having so reported.

When using these methods, the controller shall:

- i) verify that the movements of not more than one radar position indication correspond with those of the aircraft; and
- ii) ensure that the manoeuvre(s) will not carry the aircraft outside the coverage of the radar or situation display.

Note 1.— Caution must be exercised when employing these methods in areas where route changes normally take place.

Note 2.— With reference to ii) above, see also 8.6.5.1 regarding vectoring of controlled aircraft.

8.6.2.5 ADDITIONAL IDENTIFICATION METHOD

8.6.2.5.1 When two or more indications are observed in close proximity, or are observed to be making similar movements at the same time, or when doubt exists as to the identity of a position indication for any other reason, changes of heading should be prescribed or repeated as many times as necessary, or additional methods of identification should be employed, until all risk of error in identification is eliminated.

8.6.3 Transfer of radar identification

8.6.3.1 Transfer of identification from one radar controller to another should only be attempted when it is considered that the aircraft is within the accepting controller's surveillance coverage.

8.6.3.2 Transfer of identification shall be effected by one of the following methods:

- a) designation of the position indication by automated means, provided that only one position indication is thereby indicated and there is no possible doubt of correct identification;
- b) notification of the aircraft's discrete code or aircraft address;

Note 1.— The use of a discrete SSR code requires a system of code assignment which ensures that each aircraft in a given portion of airspace is assigned a discrete code (see 8.5.2.2.7).

Note 2.— Aircraft address would be expressed in the form of the alphanumeric code of six hexadecimal characters.

- c) notification that the aircraft is SSR Mode S-equipped with an aircraft identification feature when SSR Mode S coverage is available;
- d) notification that the aircraft is ADS-B-equipped with an aircraft identification feature when compatible ADS-B coverage is available;

e) direct designation (pointing with the finger) of the position indication, if the two situation displays are adjacent, or if a common “conference” type of situation display is used;

Note.— Attention must be given to any errors which might occur due to parallax effects.

f) designation of the position indication by reference to, or in terms of bearing and distance from, a geographical position or navigational facility accurately indicated on both situation displays, together with the track of the observed position indication if the route of the aircraft is not known to both controllers;

Note.— Caution must be exercised before transferring identification using this method, particularly if other position indications are observed on similar headings and in close proximity to the aircraft under control. Inherent radar deficiencies, such as inaccuracies in bearing and distance of the radar position indications displayed on individual situation displays and parallax errors, may cause the indicated position of an aircraft in relation to the known point to differ between the two situation displays. The ANSP may, therefore, prescribe additional conditions for the application of this method, e.g.:

- i. a maximum distance from the common reference point used by the two controllers; and
- ii. a maximum distance between the position indication as observed by the accepting controller and the one stated by the transferring controller.

g) where applicable, issuance of an instruction to the aircraft by the transferring controller to change SSR code and the observation of the change by the accepting controller; or

h) issuance of an instruction to the aircraft by the transferring controller to squawk/transmit IDENT and observation of this response by the accepting controller;

Note.— Use of procedures g) and h) requires prior coordination between the controllers, since the indications to be observed by the accepting controller are of short duration.

8.6.4 Position information

8.6.4.1 An aircraft provided with ATS surveillance service should be informed of its position in the following circumstances:

a) upon identification, except when the identification is established:

i) based on the pilot’s report of the aircraft position or within one nautical mile of the runway upon departure and the observed position on the situation display is consistent with the aircraft’s time of departure; or

ii) by use of ADS-B aircraft identification, Mode S aircraft identification or assigned discrete SSR codes and the location of the observed position indication is consistent with the current flight plan of the aircraft; or

iii) by transfer of identification;

- b) when the pilot requests this information;
- c) when a pilot's estimate differs significantly from the controller's estimate based on observed position;
- d) when the pilot is instructed to resume own navigation after vectoring if the current instructions had diverted the aircraft from a previously assigned route, (see 8.6.5.5);
- e) immediately before termination of ATS surveillance service, if the aircraft is observed to deviate from its intended route.

8.6.4.2 Position information shall be passed to aircraft in one of the following forms:

- a) as a well-known geographical position;
- b) magnetic track and distance to a significant point, an en-route navigation aid, or an approach aid;
- c) direction (using points of the compass) and distance from a known position;
- d) distance to touchdown, if the aircraft is on final approach; or
- e) distance and direction from the centre line of an ATS route.

8.6.4.3 Whenever practicable, position information shall relate to positions or routes pertinent to the navigation of the aircraft concerned and shown on the situation display map.

8.6.4.4 When so informed, the pilot may omit position reports at compulsory reporting points or report only over those reporting points specified by the air traffic services unit concerned. Unless automated position reporting is in effect (e.g. ADS-C), pilots shall resume voice or CPDLC position reporting:

- a) when so instructed;
- b) when advised that the ATS surveillance service has been terminated; or
- c) when advised that identification is lost.

8.6.5 Vectoring

8.6.5.1 Vectoring shall be achieved by issuing to the pilot specific headings which will enable the aircraft to maintain the desired track. When vectoring an aircraft, a controller shall comply with the following:

- a) whenever practicable, the aircraft shall be vectored along tracks on which the pilot can monitor the aircraft position with reference to pilot-interpreted navigation aids (this will minimize the amount of navigational assistance required and alleviate the consequences resulting from an ATS surveillance system failure);
- b) when an aircraft is given its initial vector diverting it from a previously assigned route, the pilot shall be informed what the vector is to accomplish, and the limit of the vector shall be specified (e.g. to ... position, for ... approach);
- c) except when transfer of control is to be effected, aircraft shall not be vectored closer than 4.6 km (2.5 NM) or, where the minimum permissible separation is greater than 9.3 km (5 NM), a distance equivalent to one-half of the prescribed separation minimum, from the limit of the airspace for which the controller is responsible, unless local arrangements have been made to ensure that separation will exist with aircraft operating in adjoining areas;
- d) controlled flights shall not be vectored into uncontrolled airspace except in the case of emergency or in order to circumnavigate adverse meteorological conditions (in which case the pilot should be so informed), or at the specific request of the pilot; and
- e) when an aircraft has reported unreliable directional instruments, the pilot shall be requested, prior to the issuance of manoeuvring instructions, to make all turns at an agreed rate and to carry out the instructions immediately upon receipt.

8.6.5.2 When vectoring an IFR flight and when giving an IFR flight a direct routing which takes the aircraft off an ATS route, the controller shall issue clearances such that the prescribed obstacle clearance will exist at all times until the aircraft reaches the point where the pilot will resume own navigation. When necessary, the relevant minimum vectoring altitude shall include a correction for low temperature effect.

Note 1.— When an IFR flight is being vectored, the pilot may be unable to determine the aircraft's exact position in respect to obstacles in this area and consequently the altitude which provides the required obstacle clearance. Detailed obstacle clearance criteria are contained in PANS-OPS (Doc 8168), Volumes I and II. See also 8.6.8.2.

Note 2.— It is the responsibility of the ANSP to provide the controller with minimum altitudes corrected for temperature effect.

8.6.5.3 Whenever possible, minimum vectoring altitudes should be sufficiently high to minimize activation of aircraft ground proximity warning systems.

Note.— Activation of such systems will induce aircraft to pull up immediately and climb steeply to avoid hazardous terrain, possibly compromising separation between aircraft.

8.6.5.4 The ANSP shall encourage operators to report incidents involving activations of aircraft ground proximity warning systems so that their locations can be identified and altitude, routing and/or aircraft operating procedures can be altered to prevent recurrences.

8.6.5.5 In terminating vectoring of an aircraft, the controller shall instruct the pilot to resume own navigation, giving the pilot the aircraft's position and appropriate instructions, as necessary, in the form prescribed in 8.6.4.2 (b), if the current instructions had diverted the aircraft from a previously assigned route.

8.6.6 Navigation assistance

8.6.6.1 An identified aircraft observed to deviate significantly from its intended route or designated holding pattern shall be advised accordingly. Appropriate action shall also be taken if, in the opinion of the controller, such deviation is likely to affect the service being provided.

8.6.6.2 The pilot of an aircraft requesting navigation assistance from an air traffic control unit providing ATS surveillance services shall state the reason (e.g. to avoid areas of adverse weather or unreliable navigational instruments) and shall give as much information as possible in the circumstances.

8.6.7 Interruption or termination of ATS surveillance service

8.6.7.1 An aircraft which has been informed that it is provided with ATS surveillance service should be informed immediately when, for any reason, the service is interrupted or terminated.

Note.— The transition of an aircraft across adjoining areas of radar and/or ADS-B and/or MLAT systems coverage will not normally constitute an interruption or termination of the ATS surveillance service.

8.6.7.2 When the control of an identified aircraft is to be transferred to a control sector that will provide the aircraft with procedural separation, the transferring controller shall ensure that appropriate procedural separation is established between that aircraft and any other controlled aircraft before the transfer is effected.

8.6.8 Minimum levels

8.6.8.1 The controller shall at all times be in possession of full and up-to-date information regarding:

- a) established minimum flight altitudes within the area of responsibility;
- b) the lowest usable flight level or levels determined in accordance with Chapters 4 and 5; and
- c) established minimum altitudes applicable to procedures based on tactical vectoring.

8.6.8.2 Unless otherwise specified by the ANSP, minimum altitudes for procedures based on tactical vectoring with any ATS surveillance system shall be determined using the criteria applicable to tactical radar vectoring.

Note.— Criteria for the determination of minimum altitudes applicable to procedures based on tactical radar vectoring are contained in Procedures for Air Navigation Services — Aircraft Operations (PANS-OPS, Doc 8168), Volume II.

8.6.9 Information regarding adverse weather

8.6.9.1 Information that an aircraft appears likely to penetrate an area of adverse weather should be issued in sufficient time to permit the pilot to decide on an appropriate course of action, including that of requesting advice on how best to circumnavigate the adverse weather area, if so desired.

Note.— Depending on the capabilities of the ATS surveillance system, areas of adverse weather may not be presented on the situation display. An aircraft's weather radar will normally provide better detection and definition of adverse weather than radar sensors in use by ATS.

8.6.9.2 In vectoring an aircraft for circumnavigating any area of adverse weather, the radar controller should ascertain that the aircraft can be returned to its intended or assigned flight path within the coverage of the ATS surveillance system, and, if this does not appear possible, inform the pilot of the circumstances.

Note.— Attention must be given to the fact that under certain circumstances the most active area of adverse weather may not be displayed.

8.6.10 Reporting of significant meteorological information to meteorological offices

8.6.10.1 Although a controller is not required to keep a special watch for heavy precipitation, etc., information on the position, intensity, extent and movement of significant meteorological conditions (i.e. heavy showers or well-defined frontal surfaces) as observed on situation displays should, when practicable, be reported to the associated meteorological office.

8.7 USE OF ATS SURVEILLANCE SYSTEMS IN THE AIR TRAFFIC CONTROL SERVICE

Note.— The procedures in this Section are general procedures applicable when an ATS surveillance system is used in the provision of area control service or approach control service. Additional procedures applicable in the provision of approach control service are detailed in Section 8.9.

8.7.1 Functions

8.7.1.1 The information provided by ATS surveillance systems and presented on a situation display may be used to perform the following functions in the provision of air traffic control service:

- a) provide ATS surveillance services as necessary in order to improve airspace utilization, reduce delays, provide for direct routings and more optimum flight profiles, as well as to enhance safety;

- b) provide vectoring to departing aircraft for the purpose of facilitating an expeditious and efficient departure flow and expediting climb to cruising level;
- c) provide vectoring to aircraft for the purpose of resolving potential conflicts;
- d) provide vectoring to arriving aircraft for the purpose of establishing an expeditious and efficient approach sequence;
- e) provide vectoring to assist pilots in their navigation, e.g. to or from a radio navigation aid, away from or around areas of adverse weather;
- f) provide separation and maintain normal traffic flow when an aircraft experiences communication failure within the area of coverage;
- g) maintain flight path monitoring of air traffic;

Note.— Where tolerances regarding such matters as adherence to track, speed or time have been prescribed by the ANSP, deviations are not considered significant until such tolerances are exceeded.

- h) when applicable, maintain a watch on the progress of air traffic, in order to provide a procedural controller with:
 - i) improved position information regarding aircraft under control;
 - ii) supplementary information regarding other traffic; and
 - iii) information regarding any significant deviations by aircraft from the terms of their respective air traffic control clearances, including their cleared routes as well as levels, when appropriate.

8.7.2 Separation application

Note.— Factors which the controller using an ATS surveillance system must take into account in determining the spacing to be applied in particular circumstances in order to ensure that the separation minimum is not infringed include aircraft relative headings and speeds, ATS surveillance system technical limitations, controller workload and any difficulties caused by communication congestion. Guidance material on this subject is contained in the Air Traffic Services Planning Manual (Doc 9426).

8.7.2.1 Except as provided for in 8.7.2.8, 8.7.2.9 and 8.8.2.2, the separation minima specified in 8.7.3 shall only be applied between identified aircraft when there is reasonable assurance that identification will be maintained.

8.7.2.2 When control of an identified aircraft is to be transferred to a control sector that will provide the aircraft with procedural separation, such separation shall be established by the transferring controller before the aircraft reaches the limits of the transferring controller's area of responsibility, or before the aircraft leaves the relevant area of surveillance coverage.

8.7.2.3 When authorized by the ANSP, separation based on the use of ADS-B, SSR and/or MLAT, and/or PSR position symbols and/or PSR blips shall be applied so that the distance between the centres of the position symbols and/or PSR blips, representing the positions of the aircraft concerned, is never less than a prescribed minimum.

8.7.2.4 Separation based on the use of PSR blips and SSR responses shall be applied so that the distance between the centre of the PSR blip and the nearest edge of the SSR response (or centre, when authorized by the ANSP) is never less than a prescribed minimum.

8.7.2.5 Separation based on the use of ADS-B position symbols and SSR responses shall be applied so that the distance between the centre of the ADS-B position symbol and the nearest edge of the SSR response (or the centre, when authorized by the ANSP) is never less than a prescribed minimum.

8.7.2.6 Separation based on the use of SSR responses shall be applied so that the distance between the closest edges of the SSR responses (of the centres, when authorized by the ANSP) is never less than a prescribed minimum.

8.7.2.7 In no circumstances shall the edges of the position indications touch or overlap unless vertical separation is applied between the aircraft concerned, irrespective of the type of position indication displayed and separation minimum applied.

8.7.2.8 In the event that the controller has been notified of a controlled flight entering or about to enter the airspace within which the separation minima specified in 8.7.3 is applied, but has not identified the aircraft, the controller may, if so prescribed by the ANSP, continue to provide an ATS surveillance service to identified aircraft provided that:

- a) reasonable assurance exists that the unidentified controlled flight will be identified using SSR and/or ADS-B and/or MLAT or the flight is being operated by an aircraft of a type which may be expected to give an adequate return on primary radar in the airspace within which the separation is applied; and
- b) the separation is maintained between identified flights and any other observed ATS surveillance system position indications until either the unidentified controlled flight has been identified or procedural separation has been established.

8.7.2.9 The separation minima specified in 8.7.3 may be applied between an aircraft taking off and a preceding departing aircraft or other identified traffic provided there is reasonable assurance that the departing aircraft will be identified within 2 km (1 NM) from the end of the runway, and that, at the time, the required separation will exist.

8.7.2.10 The separation minima specified in 8.7.3 shall not be applied between aircraft holding over the same holding fix. Application of ATS surveillance system

separation minima based on radar and/or ADS-B and/or MLAT system between holding aircraft and other flights shall be subject to requirements and procedures prescribed by the ANSP.

8.7.3 Separation minima based on ATS surveillance systems

8.7.3.1 Unless otherwise prescribed in accordance with 8.7.3.2, 8.7.3.3 or 8.7.3.4, or Chapter 6 (with respect to independent and dependent parallel approaches), the horizontal separation minimum based on radar and/or ADS-B and/or MLAT systems shall be 9.3 km (5.0 NM).

8.7.3.2 The separation minimum in 8.7.3.1 may, if so prescribed by the appropriate the ANSP, be reduced, but not below:

a) 5.6 km (3.0 NM) when radar and/or ADS-B and/or MLAT systems' capabilities at a given location so permit; and

b) 4.6 km (2.5 NM) between succeeding aircraft which are established on the same final approach track within 18.5 km (10 NM) of the runway threshold. A reduced separation minimum of 4.6 km (2.5 NM) may be applied, provided:

i) the average runway occupancy time of landing aircraft is proven, by means such as data collection and statistical analysis and methods based on a theoretical model, not to exceed 50 seconds;

ii) braking action is reported as good and runway occupancy times are not adversely affected by runway contaminants such as slush, snow or ice;

iii) an ATS surveillance system with appropriate azimuth and range resolution and an update rate of 5 seconds or less is used in combination with suitable displays;

iv) the aerodrome controller is able to observe, visually or by means of surface movement radar (SMR), MLAT system or a surface movement guidance and control system (SMGCS), the runway-in-use and associated exit and entry taxiways;

v) distance-based wake turbulence separation minima in 8.7.3.4, or as may be prescribed by the ANSP (e.g. for specific aircraft types), do not apply;

vi) aircraft approach speeds are closely monitored by the controller and when necessary adjusted so as to ensure that separation is not reduced below the minimum;

vii) aircraft operators and pilots have been made fully aware of the need to exit the runway in an expeditious manner whenever the reduced separation minimum on final approach is applied; and

viii) procedures concerning the application of the reduced minimum are published in AIPs.

8.7.3.3 The separation minimum or minima based on radar and/or ADS-B and/or MLAT systems to be applied shall be prescribed by the ANSP according to the capability of the particular ATS surveillance system or sensor to accurately identify the aircraft position in relation to the centre of a position symbol, PSR blip, SSR response and taking into account factors which may affect the accuracy of the ATS surveillance system-derived information, such as aircraft range from the radar site and the range scale of the situation display in use.

8.7.3.4 The following distance-based wake turbulence separation minima shall be applied to aircraft being provided with an ATS surveillance service (radar) in the approach and departure phases of flight in the circumstances given in 8.7.3.4.1.

<i>Aircraft category</i>		
<i>Preceding aircraft</i>	<i>Succeeding aircraft</i>	<i>Wake turbulence radar separation minima</i>
A380-800	A380-800	Not required*
A380-800 non-A380-800 HEAVY	non-A380-800 HEAVY non-A380-800 HEAVY	6.0 NM 4.0 NM
A380-800 non-A380-800 HEAVY	MEDIUM MEDIUM	7.0 NM 5.0 NM
A380-800 non-A380-800 HEAVY	LIGHT LIGHT	8.0 NM 6.0 NM
MEDIUM	LIGHT	5.0 NM

* When a wake turbulence restriction is not required, then the separation reverts to radar separation minimum as prescribed by the ANSP. The recommendation of the ad-hoc group (safety case) indicated that no wake constraint exists for the A380-800 either following another A380-800 or a non-A380-800 HEAVY aircraft.

Note.— The provisions governing wake turbulence aircraft categorization are set forth in Chapter 4, Section 4.9.

8.7.3.4.1 The minima set out in 8.7.3.4 shall be applied when:

- a) an aircraft is operating directly behind another aircraft at the same altitude or less than 1 000 ft below; or
- b) both aircraft are using the same runway, or parallel runways separated by less than 2 500 ft; or
- c) an aircraft is crossing behind another aircraft, at the same altitude or less than 1 000 ft below.

8.7.4 Transfer of control

8.7.4.1 Where an ATS surveillance service is being provided, transfer of control should be effected, whenever practicable, so as to enable the uninterrupted provision of the ATS surveillance service.

8.7.4.2 Where SSR and/or ADS-B and/or MLAT is used and the display of position indications with associated labels is provided for, transfer of control of aircraft between adjacent control positions or between adjacent ATC units may be effected without prior coordination, provided that:

a) updated flight plan information on the aircraft about to be transferred, including the discrete assigned SSR code or, with respect to Mode S and ADS-B, the aircraft identification, is provided to the accepting controller prior to transfer;

b) the ATS surveillance system coverage provided to the accepting controller is such that the aircraft concerned is presented on the situation display before the transfer is effected and is identified on, but preferably before, receipt of the initial call;

c) when the controllers are not physically adjacent, two-way direct speech facilities, which permit communications to be established instantaneously, are available between them at all times;

Note.— “Instantaneous” refers to communications which effectively provide for immediate access between controllers.

d) the transfer point or points and all other conditions of application, such as direction of flight, specified levels, transfer of communication points, and especially an agreed minimum separation between aircraft, including that applicable to succeeding aircraft on the same route, about to be transferred as observed on the situation display, have been made the subject of specific instructions (for intra-unit transfer) or of a specific letter of agreement between two adjacent ATC units;

e) the instructions or letter of agreement specify explicitly that the application of this type of transfer of control may be terminated at any time by the accepting controller, normally with an agreed advance notice;

f) the accepting controller is informed of any level, speed or vectoring instructions given to the aircraft prior to its transfer and which modify its anticipated flight progress at the point of transfer.

Note.— “Instantaneous” refers to communications which effectively provide for immediate access between controllers.

8.7.4.3 The minimum agreed separation between aircraft about to be transferred (8.7.4.2 d) refers) and the advance notice (8.7.4.2 e) refers) shall be determined taking

into account all relevant technical, operational and other circumstances. If circumstances arise in which these agreed conditions can no longer be satisfied, controllers shall revert to the procedure in 8.7.4.4 until the situation is resolved.

8.7.4.4 Where primary radar is being used, and where another type of ATS surveillance system is employed but the provisions of 8.7.4.2 are not applied, the transfer of control of aircraft between adjacent control positions or between two adjacent ATS units may be effected, provided that:

- a) identification has been transferred to or has been established directly by the accepting controller;
- b) when the controllers are not physically adjacent, two-way direct-speech facilities between them are at all times available which permit communications to be established instantaneously;
- c) separation from other controlled flights conforms to the minima authorized for use during transfer of control between the sectors or units concerned;
- d) the accepting controller is informed of any level, speed or vectoring instructions applicable to the aircraft at the point of transfer;
- e) radiocommunication with the aircraft is retained by the transferring controller until the accepting controller has agreed to assume responsibility for providing the ATS surveillance service to the aircraft. Thereafter, the aircraft should be instructed to change over to the appropriate channel and from that point is the responsibility of the accepting controller.

8.7.5 Speed control

8.7.5.1 Subject to conditions specified by the ANSP, including consideration of aircraft performance limitations, a controller may, in order to facilitate sequencing or to reduce the need for vectoring, request aircraft to adjust their speed in a specified manner.

Note.— Procedures for speed control instructions are contained in Chapter 4, Section 4.6.

8.8 EMERGENCIES, HAZARDS AND EQUIPMENT FAILURES

Note.— See also Chapter 15.

8.8.1 Emergencies

8.8.1.1 In the event of an aircraft in, or appearing to be in, any form of emergency, every assistance shall be provided by the controller, and the procedures prescribed herein may be varied according to the situation.

8.8.1.2 The progress of an aircraft in emergency shall be monitored and (whenever possible) plotted on the situation display until the aircraft passes out of coverage of the ATS surveillance system, and position information shall be provided to all air traffic services units which may be able to give assistance to the aircraft. Transfer to adjacent sectors shall also be effected when appropriate.

Note.— If the pilot of an aircraft encountering a state of emergency has previously been directed by ATC to select a specific transponder code and/or an ADS-B emergency mode, that code/mode will normally be maintained unless, in special circumstances, the pilot has decided or has been advised otherwise. Where ATC has not requested a code or emergency mode to be set, the pilot will set the transponder to Mode A Code 7700 and/or the appropriate ADS-B emergency mode.

8.8.1.3 Whenever a general ADS-B emergency alert is observed on the situation display and there is no other indication of the particular nature of the emergency, the controller shall take the following action:

- a) Attempt to establish communication with the aircraft to verify the nature of the emergency; or
- b) If no response is received from the aircraft, the controller shall attempt to ascertain if the aircraft is able to receive transmission from the air traffic control unit by requesting it to execute a specified manoeuvre which can be observed on the situation display.

Note 1. —Some aircraft equipped with first generation ADS-B avionics have the capability to transmit a general emergency alert only, regardless of the code selected by the pilot.

Note 2. — Some aircraft equipped with first generation ADS-B avionics do not have the capability of squawking IDENT while the emergency and/or urgency mode is selected.

8.8.2 Collision hazard information

8.8.2.1 When an identified controlled flight is observed to be on a conflicting path with an unknown aircraft deemed to constitute a collision hazard, the pilot of the controlled flight shall, whenever practicable:

- a) be informed of the unknown aircraft and if so requested by the controlled flight or, if in the opinion of the controller the situation warrants, a course of avoiding action should be suggested; and
- b) be notified when the conflict no longer exists.

8.8.2.2 When an identified IFR flight operating outside controlled airspace is observed to be on a conflicting path with another aircraft, the pilot should:

- a) be informed as to the need for collision avoidance action to be initiated, and if so requested by the pilot or if, in the opinion of the controller, the situation warrants, a course of avoiding action should be suggested; and
- b) be notified when the conflict no longer exists.

8.8.2.3 Information regarding traffic on a conflicting path should be given, whenever practicable, in the following form:

- a) relative bearing of the conflicting traffic in terms of the 12-hour clock;
- b) distance from the conflicting traffic in kilometers (nautical miles);
- c) direction in which the conflicting traffic appears to be proceeding;
- d) level and type of aircraft or, if unknown, relative speed of the conflicting traffic, e.g. slow or fast.

8.8.2.4 Pressure-altitude-derived level information, even when unverified, should be used in the provision of collision hazard information because such information, particularly if available from an otherwise unknown aircraft (e.g. a VFR flight) and given to the pilot of a known aircraft, could facilitate the location of a collision hazard.

8.8.2.4.1 When the pressure-altitude-derived level information has been verified, the information shall be passed to pilots in a clear and unambiguous manner. If the level information has not been verified, the accuracy of the information should be considered uncertain and the pilot shall be informed accordingly.

8.8.3 Failure of equipment

8.8.3.1.1 If two-way communication is lost with an aircraft, the controller should determine whether or not the aircraft's receiver is functioning by instructing the aircraft on the channel so far used to acknowledge by making a specified manoeuvre and by observing the aircraft's track, or by instructing the aircraft to operate IDENT or to make SSR code and/or ADS-B transmission changes.

Note 1.— Transponder-equipped aircraft experiencing radiocommunication failure will operate the transponder on Mode A Code 7600.

Note 2.— ADS-B-equipped aircraft experiencing radiocommunication failure may transmit the appropriate ADS-B emergency and/or urgency mode.

8.8.3.1.2 If the action prescribed in 8.8.3.1.1 is unsuccessful, it shall be repeated on any other available channel on which it is believed that the aircraft might be listening.

8.8.3.1.3 In both the cases covered by 8.8.3.1.1 and 8.8.3.1.2, any manoeuvring instructions shall be such that the aircraft would regain its current cleared track after having complied with the instructions received.

8.8.3.1.4 Where it has been established by the action in 8.8.3.1.1 that the aircraft's radio receiver is functioning, continued control can be effected using SSR code/ADS-B transmission changes or IDENT transmissions to obtain acknowledgement of clearances issued to the aircraft.

8.8.3.2 COMPLETE AIRCRAFT COMMUNICATION FAILURE

8.8.3.2.1 When a controlled aircraft experiencing complete communication failure is operating or expected to operate in an area and at flight levels where an ATS surveillance service is applied, separation specified in 8.7.3 may continue to be used. However, if the aircraft experiencing the communication failure is not identified, separation shall be applied between identified aircraft and all unidentified aircraft observed along the expected route of the aircraft with the communication failure, until such time as it is known, or can safely be assumed, that the aircraft with radio communication failure has passed through the airspace concerned, has landed, or has proceeded elsewhere.

8.8.3.3 AIRCRAFT TRANSPONDER FAILURE IN AREAS WHERE THE CARRIAGE OF A FUNCTIONING TRANSPONDER IS MANDATORY

8.8.3.3.1 When an aircraft experiencing transponder failure after departure is operating or expected to operate in an area where the carriage of a functioning transponder with specified capabilities is mandatory, the ATC units concerned should endeavour to provide for continuation of the flight to the aerodrome of first intended landing in accordance with the flight plan. However, in certain traffic situations, either in terminal areas or en-route, continuation of the flight may not be possible, particularly when failure is detected shortly after take-off. The aircraft may then be required to return to the departure aerodrome or to land at the nearest suitable aerodrome acceptable to the operator concerned and to ATC.

8.8.3.3.2 In case of a transponder failure which is detected before departure from an aerodrome where it is not practicable to effect a repair, the aircraft concerned should be permitted to proceed, as directly as possible, to the nearest suitable aerodrome where repair can be made. When granting clearance to such aircraft, ATC should take into consideration the existing or anticipated traffic situation and may have to modify the time of departure, flight level or route of the intended flight. Subsequent adjustments may become necessary during the course of the flight.

8.8.4 ATS surveillance system failure

8.8.4.1 In the event of complete failure of the ATS surveillance system or total radar failure, where air-ground communications remain, the controller shall plot the positions of all aircraft already identified, take the necessary action to establish procedural separation between the aircraft and, if necessary, limit the number of aircraft permitted to enter the area.

8.8.4.2 As an emergency measure, use of flight levels spaced by half the applicable vertical separation minimum may be resorted to temporarily if standard procedural separation cannot be provided immediately.

8.8.5 Degradation of aircraft position source data

8.8.5.1 In order to reduce the impact of a degradation of aircraft position source data, for example, a receiver autonomous integrity monitoring (RAIM) outage for GNSS, the ANSP shall establish contingency procedures to be followed by control positions and ATC units in the event of data degradation.

8.8.6 Ground radio failure

8.8.6.1 In the event of complete failure of the ground radio equipment used for control, the controller shall, unless able to continue to provide the ATS surveillance service by means of other available communication channels, proceed as follows:

- a) without delay inform all adjacent control positions or ATC units, as applicable, of the failure;
- b) apprise such positions or units of the current traffic situation;
- c) request their assistance, in respect of aircraft which may establish communications with those positions or units, in establishing and maintaining separation between such aircraft; and
- d) instruct adjacent control positions or ATC units to hold or re-route all controlled flights outside the area of responsibility of the position or ATC unit that has experienced the failure until such time that the provision of normal services can be resumed.

8.8.6.2 In order to reduce the impact of complete ground radio equipment failure on the safety of air traffic, the ANSP should establish contingency procedures to be followed by control positions and ATC units in the event of such failures. Where feasible and practicable, such contingency procedures should provide for the delegation of control to an adjacent control position or ATC unit in order to permit a minimum level of services to be provided as soon as possible, following the ground radio failure and until normal operations can be resumed.

8.9 USE OF ATS SURVEILLANCE SYSTEMS IN THE APPROACH CONTROL SERVICE

8.9.1 General provisions

8.9.1.1 ATS surveillance systems used in the provision of approach control service shall be appropriate to the functions and level of service to be provided.

8.9.1.2 ATS surveillance systems used to monitor parallel ILS approaches shall meet the requirements for such operations specified in Chapter 6.

8.9.2 Functions

8.9.2.1 The position indications presented on a situation display may be used to perform the following additional functions in the provision of approach control service:

- a) provide vectoring of arriving traffic on to pilot-interpreted final approach aids;
- b) provide flight path monitoring of parallel ILS approaches and instruct aircraft to take appropriate action in the event of possible or actual penetrations of the no transgression zone (NTZ);

Note.— See Chapter 6, Section 6.7.

- c) provide vectoring of arriving traffic to a point from which a visual approach can be completed;
- d) provide vectoring of arriving traffic to a point from which a precision radar approach or a surveillance radar approach can be made;
- e) provide flight path monitoring of other pilot-interpreted approaches;
- f) in accordance with prescribed procedures, conduct:
 - i) surveillance radar approaches;
 - ii) precision radar (PAR) approaches; and
- g) provide separation between:
 - i) succeeding departing aircraft;
 - ii) succeeding arriving aircraft; and
 - iii) a departing aircraft and a succeeding arriving aircraft.

8.9.3 General approach radar procedures using ATS Surveillance systems

8.9.3.1 The ANSP shall establish procedures to ensure that the aerodrome controller is kept informed of the sequence of arriving aircraft, as well as any instructions and restrictions which have been issued to such aircraft in order to maintain separation after transfer of control to the aerodrome controller.

8.9.3.2 Prior to, or upon commencement of, vectoring for approach, the pilot shall be advised of the type of approach as well as the runway to be used.

8.9.3.3 The controller shall advise an aircraft being vectored for an instrument approach of its position at least once prior to commencement of final approach.

8.9.3.4 When giving distance information, the controller shall specify the point or navigation aid to which the information refers.

8.9.3.5 The initial and intermediate approach phases of an approach executed under the direction of a controller comprise those parts of the approach from the time vectoring is initiated for the purpose of positioning the aircraft for a final approach, until the aircraft is on final approach and:

- a) established on the final approach path of a pilot-interpreted aid; or
- b) reports that it is able to complete a visual approach; or
- c) ready to commence a surveillance radar approach; or
- d) transferred to the precision radar approach controller.

8.9.3.6 Aircraft vectored for final approach should be given a heading or a series of headings calculated to close with the final approach track. The final vector shall enable the aircraft to be established in level flight on the final approach track prior to intercepting the specified or nominal glide path if an MLS, ILS or radar approach is to be made, and should provide an intercept angle with the final approach track of 45 degrees or less.

Note.— See Chapter 6, Section 6.7.3.2, concerning vectoring of independent parallel approaches.

8.9.3.7 Whenever an aircraft is assigned a vector which will take it through the final approach track, it should be advised accordingly, stating the reason for the vector.

8.9.4 Vectoring to pilot-interpreted final approach aid

8.9.4.1 An aircraft vectored to intercept a pilot-interpreted final approach aid shall be instructed to report when established on the final approach track. Clearance for the approach should be issued prior to when the aircraft reports established, unless circumstances preclude the issuance of the clearance at such time. Vectoring will normally terminate at the time the aircraft leaves the last assigned heading to intercept the final approach track.

8.9.4.2 The controller shall be responsible for maintaining separation specified in 8.7.3 between succeeding aircraft on the same final approach, except that the responsibility may be transferred to the aerodrome controller in accordance with procedures prescribed by the ANSP and provided an ATS surveillance system is available to the aerodrome controller.

8.9.4.3 Transfer of control of succeeding aircraft on final approach to the aerodrome controller shall be effected in accordance with procedures prescribed by the ANSP.

8.9.4.4 Transfer of communications to the aerodrome controller should be effected at such a point or time that clearance to land or alternative instructions can be issued to the aircraft in a timely manner.

8.9.5 Vectoring for visual approach

Note.— See also Chapter 6, Section 6.5.3.

8.9.5.1 The controller may initiate vectoring of an aircraft for visual approach provided the reported ceiling is above the minimum altitude applicable to vectoring and meteorological conditions are such that, with reasonable assurance, a visual approach and landing can be completed.

8.9.5.2 Clearance for visual approach shall be issued only after the pilot has reported the aerodrome or the preceding aircraft in sight, at which time vectoring would normally be terminated.

8.9.6 Radar approaches

Note: This section is reserved.

8.9.7 Final approach procedures

Note: This section is reserved.

8.10 USE OF ATS SURVEILLANCE SYSTEMS IN THE AERODROME CONTROL SERVICE

8.10.1 Functions

8.10.1.1 When authorized by and subject to conditions prescribed by the ANSP, ATS surveillance systems may be used in the provision of aerodrome control service to perform the following functions:

- a) flight path monitoring of aircraft on final approach;
- b) flight path monitoring of other aircraft in the vicinity of the aerodrome;
- c) establishing separation specified in 8.7.3 between succeeding departing aircraft;
and
- d) providing navigation assistance to VFR flights.

8.10.1.2 Special VFR flights shall not be vectored unless special circumstances, such as emergencies, dictate otherwise.

8.10.1.3 Caution shall be exercised when vectoring VFR flights so as to ensure that the aircraft concerned does not inadvertently enter instrument meteorological conditions.

8.10.1.4 In prescribing conditions and procedures for the use of ATS surveillance systems in the provision of aerodrome control service, the ANSP shall ensure that the availability and use of an ATS surveillance system will not be detrimental to visual observation of aerodrome traffic.

Note.— Control of aerodrome traffic is in the main based on visual observation of the manoeuvring area and the vicinity of the aerodrome by the aerodrome controller.

8.10.2 Use of ATS surveillance systems for surface movement control

Note.— Requirements concerning surface movement guidance and control systems (SMGCS) are contained in ICAO Annex 14, Volume I, Chapter 9. Guidance on the use of surface movement radar (SMR) and other advanced functions is contained in the Manual of Surface Movement Guidance and Control Systems (SMGCS) (Doc 9476) and in the Advanced Surface Movement Guidance and Control Systems (A-SMGCS) Manual (Doc 9830).

8.10.2.1 GENERAL PROVISIONS

8.10.2.1.1 The use of SMR should be related to the operational conditions and requirements of the particular aerodrome (i.e. visibility conditions, traffic density and aerodrome layout).

8.10.2.1.2 SMR systems shall to the extent possible enable the detection and display of the movement of all aircraft and vehicles on the manoeuvring area in a clear and unambiguous manner.

8.10.2.1.3 Aircraft and vehicle position indications may be displayed in symbolic or non-symbolic form. Where labels are available for display, the capability should be provided for inclusion of aircraft and vehicle identification by manual or automated means.

8.10.2.2 FUNCTIONS

8.10.2.2.1 SMR should be used to augment visual observation of traffic on the manoeuvring area and to provide surveillance of traffic on those parts of the manoeuvring area which cannot be observed visually.

8.10.2.2.2 The information displayed on an SMR display may be used to assist in:

- a) monitoring of aircraft and vehicles on the manoeuvring area for compliance with clearances and instructions;
- b) determining that a runway is clear of traffic prior to a landing or take-off;
- c) providing information on essential local traffic on or near the manoeuvring area;

- d) determining the location of aircraft and vehicles on the manoeuvring area;
- e) providing directional taxi information to aircraft when requested by the pilot or deemed necessary by the controller. Except under special circumstances, e.g. emergencies, such information should not be issued in the form of specific heading instructions; and
- f) providing assistance and advice to emergency vehicles.

8.10.2.3 IDENTIFICATION OF AIRCRAFT

8.10.2.3.1 Where an ATS surveillance system is used, aircraft may be identified by one or more of the following procedures:

- a) by correlating a particular position indication with:
 - i) an aircraft position visually observed by the controller;
 - ii) an aircraft position reported by the pilot; or
 - iii) an identified position indication displayed on a situation display;
- b) by transfer of identification when authorized by the ANSP; and
- c) by automated identification procedures when authorized by the ANSP.

8.11 USE OF ATS SURVEILLANCE SYSTEMS IN THE FLIGHT INFORMATION SERVICE

Note.— The use of an ATS surveillance system in the provision of flight information service does not relieve the pilot-in-command of an aircraft of any responsibilities, including the final decision regarding any suggested alteration of the flight plan.

8.11.1 Functions

8.11.1.1 The information presented on a situation display may be used to provide identified aircraft with:

- a) information regarding any aircraft observed to be on a conflicting path with the identified aircraft and suggestions or advice regarding avoiding action;
- b) information on the position of significant weather and, as practicable, advice to the aircraft on how best to circumnavigate any such areas of adverse weather (see 8.6.9.2, Note);
- c) information to assist the aircraft in its navigation.

CHAPTER 9

FLIGHT INFORMATION SERVICE AND ALERTING SERVICE

9.1 FLIGHT INFORMATION SERVICE

9.1.1 Recording and transmission of information on the progress of flights

9.1.1.1 Information on the actual progress of flights, including those of heavy or medium unmanned free balloons, under neither air traffic control service nor air traffic advisory service shall be:

- a) recorded by the air traffic services unit serving the FIR within which the aircraft is flying in such a manner that it is available for reference and in case it is requested for search and rescue action;
- b) transmitted by the air traffic services unit receiving the information to other air traffic services units concerned, when so required in accordance with Chapter 10, 10.2.2.

9.1.2 Transfer of responsibility for the provision of flight information service

9.1.2.1 The responsibility for the provision of flight information service to a flight normally passes from the appropriate ATS unit in an FIR to the appropriate ATS unit in the adjacent FIR at the time of crossing the common FIR boundary. However, when coordination is required in accordance with Chapter 8, 8.2.1, but communication facilities are inadequate, the former ATS unit shall, as far as practicable, continue to provide flight information service to the flight until it has established two-way communication with the appropriate ATS unit in the FIR it is entering.

9.1.3 Transmission of information

9.1.3.1 MEANS OF TRANSMISSION

9.1.3.1.1 Except as provided in 9.1.3.2.1, information shall be disseminated to aircraft by one or more of the following means as determined by the ANSP:

- a) the preferred method of directed transmission on the initiative of the appropriate ATS unit to an aircraft, ensuring that receipt is acknowledged; or
- b) a general call, unacknowledged transmission to all aircraft concerned; or

- c) broadcast; or
- d) data link.

Note.— It should be recognized that in certain circumstances, e.g. during the last stages of a final approach, it may be impracticable for aircraft to acknowledge directed transmissions.

9.1.3.1.2 The use of general calls shall be limited to cases where it is necessary to disseminate essential information to several aircraft without delay, e.g. the sudden occurrence of hazards, a change of the runway-in-use, or the failure of a key approach and landing aid.

9.1.3.2 TRANSMISSION OF SPECIAL AIR-REPORTS AND SIGMET INFORMATION

9.1.3.2.1 Appropriate SIGMET and special air-reports, which have not been used for the preparation of a SIGMET, shall be disseminated to aircraft by one or more of the means specified in 9.1.3.1.1 as determined on the basis of regional air navigation agreements. Special air-reports shall be disseminated to aircraft for a period of 60 minutes after their issuance.

9.1.3.2.2 The special air-report and SIGMET information to be passed to aircraft on ground initiative should cover a portion of the route up to one hour's flying time ahead of the aircraft except when another period has been determined on the basis of regional air navigation agreements.

9.1.3.3 TRANSMISSION OF INFORMATION CONCERNING VOLCANIC ACTIVITY

9.1.3.3.1 Information concerning pre-eruption volcanic activity, volcanic eruptions and volcanic ash clouds (position of clouds and flight levels affected) shall be disseminated to aircraft by one or more of the means specified in 9.1.3.1.1 as determined on the basis of regional air navigation agreements.

9.1.3.4 TRANSMISSION OF INFORMATION CONCERNING RADIOACTIVE MATERIALS AND TOXIC CHEMICAL CLOUDS

9.1.3.4.1 Information on the release into the atmosphere of radioactive materials or toxic chemicals, which could affect airspace within the area of responsibility of the ATS unit, shall be transmitted to aircraft by one or more of the means specified in 9.1.3.1.1.

9.1.3.5 TRANSMISSION OF SPECI AND AMENDED TAF

9.1.3.5.1 Special reports in the SPECI code form and amended TAF shall be transmitted on request and supplemented by:

- a) directed transmission from the appropriate air traffic services unit of selected special reports and amended TAF for the departure, destination and its alternate

aerodromes, as listed in the flight plan; or

b) a general call on appropriate frequencies for the unacknowledged transmission to affected aircraft of selected special reports and amended TAF; or

c) continuous or frequent broadcast or the use of data link to make available current METAR and TAF in areas determined on the basis of regional air navigation agreements where traffic congestion dictates. VOLMET broadcasts and/ or D-VOLMET should be used to serve this purpose (see ICAO Annex 11, 4.4).

9.1.3.5.2 The passing of amended aerodrome forecasts to aircraft on the initiative of the appropriate air traffic services unit should be limited to that portion of the flight where the aircraft is within a specified time from the aerodrome of destination, such time being established on the basis of regional air navigation agreements.

9.1.3.6 TRANSMISSION OF INFORMATION ON HEAVY OR MEDIUM UNMANNED FREE BALLOONS

Note: This section is reserved.

9.1.3.7 TRANSMISSION OF INFORMATION TO SUPERSONIC AIRCRAFT

Note: This section is reserved.

9.1.4 Air traffic advisory service

Note: This section is reserved.

9.2 ALERTING SERVICE

9.2.1 Aircraft

Note.— Whenever applied, the procedures for the provision of air traffic control service take the place of the following procedures, except when relevant procedures do not call for more than hourly position reports, in which case the Operations normal procedure applies.

9.2.1.1 When so required by the ANSP to facilitate the provision of alerting and search and rescue services, an aircraft, prior to and when operating within or into designated areas or along designated routes, shall comply with the provisions detailed in ICAO Annex 2, Chapter 3, concerning the submission, completion, changing and closing of a flight plan.

9.2.1.2 In addition to the above, aircraft equipped with suitable two-way radio communications shall report during the period twenty to forty minutes following the time of last contact, whatever the purpose of such contact, merely to indicate that the flight is progressing according to plan, such report to comprise identification of the aircraft and the words “Operations normal” or the signal QRU.

9.2.1.3 The “Operations normal” message shall be transmitted air-ground to an appropriate air traffic services unit (e.g. normally to the aeronautical telecommunication station serving the air traffic services unit in charge of the FIR in which the aircraft is flying, otherwise to another aeronautical telecommunication station to be retransmitted as required to the air traffic services unit in charge of the FIR).

9.2.1.4 It may be advisable, in case of a SAR operation of a substantial duration, to promulgate by NOTAM the lateral and vertical limits of the area of SAR action, and to warn aircraft not engaged in actual SAR operations and not controlled by air traffic control to avoid such areas unless otherwise authorized by the appropriate ATS unit.

9.2.2 Air traffic services units

9.2.2.1 When no report from an aircraft has been received within a reasonable period of time (which may be a specified interval prescribed on the basis of regional air navigation agreements) after a scheduled or expected reporting time, the ATS unit shall, within the stipulated period of thirty minutes, endeavour to obtain such report in order to be in a position to apply the provisions relevant to the “Uncertainty Phase”, “Alert Phase” or “Distress Phase” (ICAO Annex 11, 5.2.1 refers) should circumstances warrant such application.

9.2.2.2 When alerting service is required in respect of a flight operated through more than one FIR or control area, and when the position of the aircraft is in doubt, responsibility for coordinating such service shall rest with the ATS unit of the FIR or control area:

- 1) within which the aircraft was flying at the time of last air-ground radio contact;
- 2) that the aircraft was about to enter when last air-ground contact was established at or close to the boundary of two FIRs or control areas;
- 3) within which the aircraft’s intermediate stop or final destination point is located:
 - a) if the aircraft was not equipped with suitable two-way radio communication equipment; or
 - b) was not under obligation to transmit position reports.

9.2.2.3 The unit responsible for alerting service, in accordance with 9.2.2.2, shall:

— notify units providing alerting service in other affected FIRs or control areas of the emergency phase or phases, in addition to notifying the rescue coordination centre associated with it;

— request those units to assist in the search for any useful information pertaining to the aircraft presumed to be in an emergency, by all appropriate means and

especially those indicated in 5.3 of ICAO Annex 11 (Use of communication facilities);

— collect the information gathered during each phase of the emergency and, after verifying it as necessary, transmit it to the rescue coordination centre;

— announce the termination of the state of emergency as circumstances dictate.

9.2.2.4 In obtaining the necessary information as required under 5.2.2.1 of ICAO Annex 11, attention shall particularly be given to informing the relevant rescue coordination centre of the distress frequencies available to survivors, as listed in Item 19 of the flight plan but not normally transmitted.

CHAPTER 10

COORDINATION

10.1 COORDINATION IN RESPECT OF THE PROVISION OF AIR TRAFFIC CONTROL SERVICE

10.1.1 GENERAL

10.1.1.1 The coordination and transfer of control of a flight between successive ATC units and control sectors shall be effected by a dialogue comprising the following stages:

- a) notification of the flight in order to prepare for coordination, as necessary;
- b) coordination of conditions of transfer of control by the transferring ATC unit;
- c) coordination, if necessary, and acceptance of conditions of transfer of control by the accepting ATC unit; and
- d) the transfer of control to the accepting ATC unit or control sector.

10.1.1.2 ATC units should, to the extent possible, establish and apply standardized procedures for the coordination and transfer of control of flights, in order, inter alia, to reduce the need for verbal coordination. Such coordination procedures shall conform to the procedures contained in the following provisions and be specified in letters of agreement and local instructions, as applicable.

10.1.1.3 Such agreements and instructions shall cover the following as applicable:

- a) definition of areas of responsibility and common interest, airspace structure and airspace classification(s);
- b) any delegation of responsibility for the provision of ATS;
- c) procedures for the exchange of flight plan and control data, including use of automated and/or verbal coordination messages;
- d) means of communication;
- e) requirements and procedures for approval requests;
- f) significant points, levels or times for transfer of control;

- g) significant points, levels or times for transfer of communication;
- h) conditions applicable to the transfer and acceptance of control, such as specified altitudes/flight levels, specific separation minima or spacing to be established at the time of transfer, and the use of automation;
- i) ATS surveillance system coordination procedures;
- j) SSR code assignment procedures;
- k) procedures for departing traffic;
- l) designated holding fixes and procedures for arriving traffic;
- m) applicable contingency procedures; and
- n) any other provisions or information relevant to the coordination and transfer of control of flights.

10.1.2 Coordination between ATC units providing air traffic service within contiguous control areas

10.1.2.1 GENERAL

10.1.2.1.1 ATC units shall forward from unit to unit, as the flight progresses, necessary flight plan and control information. When so required by agreement between the appropriate ATS authorities to assist in the separation of aircraft, flight plan and flight progress information for flights along specified routes or portions of routes in close proximity to flight information region boundaries shall also be provided to the ATC units in charge of the flight information regions adjacent to such routes or portions of routes.

Note 1.— Such a route or portion of route is often referred to as an area of common interest, the extent of which is usually determined by the required separation minima.

Note 2.— See also 10.2.4.

10.1.2.1.2 The flight plan and control information shall be transmitted in sufficient time to permit reception and analysis of the data by the receiving unit(s) and necessary coordination between the units concerned.

Note.— See Chapter 11 and Appendices 3 and 6 for details regarding messages, their content and time of transmission.

10.1.2.2 TRANSFER OF CONTROL

10.1.2.2.1 The responsibility for the control of an aircraft shall be transferred from the ATC unit to the next unit at the time of crossing the common control area

boundary as determined by the unit having control of the aircraft or at such other point or time as has been agreed between the two units.

10.1.2.2.2 Where specified in letters of agreement between the ATC units concerned, and when transferring an aircraft, the transferring unit shall notify the accepting unit that the aircraft is in position to be transferred, and specify that the responsibility for control should be assumed by the accepting unit forthwith at the time of crossing the control boundary or other transfer control point specified in letters of agreement between the ATC units or at such other point or time coordinated between the two units.

10.1.2.2.3 If the transfer of control time or point is other than forthwith, the accepting ATC unit shall not alter the clearance of the aircraft prior to the agreed transfer of control time or point without the approval of the transferring unit.

10.1.2.2.4 If transfer of communication is used to transfer an aircraft to a receiving ATC unit, responsibility for control shall not be assumed until the time of crossing the control area boundary or other transfer of control point specified in letters of agreement between the ATC units.

10.1.2.2.5 When transfer of control of identified aircraft is to be effected, the appropriate procedures specified in Chapter 8, Section 8.7.4, shall be applied.

10.1.2.3 APPROVAL REQUESTS

10.1.2.3.1 If the flying time from the departure aerodrome of an aircraft to the boundary of an adjacent control area is less than the specified minimum required to permit transmission of the necessary flight plan and control information to the accepting ATC unit after take-off and allow adequate time for reception, analysis and coordination, the transferring ATC unit shall, prior to departure, forward that information to the accepting ATC unit together with a request for approval. The required time period shall be specified in letters of agreement or local instructions, as appropriate. In the case of revisions to a previously transmitted current flight plan, and control data being transmitted earlier than this specified time period, no approval from the accepting ATC unit shall be required.

10.1.2.3.2 In the case of an aircraft in flight requiring an initial clearance when the flying time to the boundary of an adjacent control area is less than a specified minimum, the aircraft shall be held within the transferring ATC unit's control area until the flight plan and control information have been forwarded together with a request for approval, and coordination effected, with the adjacent ATC unit.

10.1.2.3.3 In the case of an aircraft requesting a change in its current flight plan, or of a transferring ATC unit proposing to change the current flight plan of an aircraft, and the flying time of the aircraft to the control area boundary is less than a specified minimum, the revised clearance shall be withheld pending approval of the proposal by the adjacent ATC unit.

10.1.2.3.4 When boundary estimate data are to be transmitted for approval by the accepting unit, the time in respect of an aircraft not yet departed shall be based upon the estimated time of departure as determined by the ATC unit in whose area of responsibility the departure aerodrome is located. In respect of an aircraft in flight requiring an initial clearance, the time shall be based on the estimated elapsed time from the holding fix to the boundary plus the time expected to be needed for coordination.

10.1.2.3.5 The conditions, including specified flying times, under which approval requests shall be forwarded, shall be specified in letters of agreement or local instructions as appropriate.

10.1.2.4 TRANSFER OF COMMUNICATION

10.1.2.4.1 Except when separation minima specified in 8.7.3 are being applied, the transfer of air-ground communications of an aircraft from the transferring to the accepting ATC unit shall be made five minutes before the time at which the aircraft is estimated to reach the common control area boundary, unless otherwise agreed between the two ATC units concerned.

10.1.2.4.2 When separation minima specified in 8.7.3 are being applied at the time of transfer of control, the transfer of air-ground communications of an aircraft from the transferring to the accepting ATC unit shall be made immediately after the accepting ATC unit has agreed to assume control.

10.1.2.4.3 The accepting ATC unit shall normally not be required to notify the transferring unit that radio and/or data communication has been established with the aircraft being transferred and that control of the aircraft has been assumed, unless otherwise specified by agreement between the ATC units concerned. The accepting ATC unit shall notify the transferring unit in the event that communication with the aircraft is not established as expected.

10.1.2.4.4 In cases where a portion of a control area is so situated that the time taken by aircraft to traverse it is of a limited duration, agreement should be reached to provide for direct transfer of communication between the units responsible for the adjacent control areas, provided that the intermediate unit is fully informed of such traffic. The intermediate unit shall retain responsibility for coordination and for ensuring that separation is maintained between all traffic within its area of responsibility.

10.1.2.4.5 An aircraft may be permitted to communicate temporarily with a control unit other than the unit controlling the aircraft.

10.1.2.5 TERMINATION OF CONTROLLED FLIGHT

In the case where a flight ceases to be operated as a controlled flight, i.e. by leaving controlled airspace or by cancelling its IFR flight and proceeding on VFR in airspace where VFR flights are not controlled, the ATC unit concerned shall ensure that appropriate information on the flight is forwarded to ATS unit(s) responsible for the

provision of flight information and alerting services for the remaining portion of the flight, in order to ensure that such services will be provided to the aircraft.

10.1.3 Coordination between a unit providing area control service and a unit providing approach control service

10.1.3.1 DIVISION OF CONTROL

10.1.3.1.1 Except when otherwise specified in letters of agreement or local instructions, or by the ACC concerned in individual cases, a unit providing approach control service may issue clearances to any aircraft released to it by an ACC without reference to the ACC. However, when an approach has been missed the ACC shall, if affected by the missed approach, be advised immediately and subsequent action coordinated between the ACC and the unit providing approach control service as necessary.

10.1.3.1.2 An ACC may, after coordination with the unit providing approach control service, release aircraft directly to aerodrome control towers if the entire approach will be made under visual meteorological conditions.

10.1.3.2 TAKE-OFF AND CLEARANCE EXPIRY TIMES

10.1.3.2.1 Time of take-off shall be specified by the ACC when it is necessary to:

- a) coordinate the departure with traffic not released to the unit providing approach control service; and
- b) provide en-route separation between departing aircraft following the same track.

10.1.3.2.2 If time of take-off is not specified, the unit providing approach control service shall determine the take-off time when necessary to coordinate the departure with traffic released to it.

10.1.3.2.3 A clearance expiry time shall be specified by the ACC if a delayed departure would conflict with traffic not released to the unit providing approach control service. If, for traffic reasons of its own, a unit providing approach control service has to specify in addition its own clearance expiry time, this shall not be later than that specified by the ACC.

10.1.3.3 EXCHANGE OF MOVEMENT AND CONTROL DATA

10.1.3.3.1 The unit providing approach control service shall keep the ACC promptly advised of pertinent data on controlled traffic such as:

- a) runway(s)-in-use and expected type of instrument approach procedure;
- b) lowest vacant level at the holding fix available for use by the ACC;

- c) average time interval or distance between successive arrivals as determined by the unit providing approach control service;
- d) revision of the expected approach time issued by the ACC when the calculation of the expected approach time by the unit providing approach control service indicates a variation of five minutes or such other time as has been agreed between the two ATC units concerned;
- e) arrival times over the holding fix when these vary by three minutes, or such other time as has been agreed between the two ATC units concerned, from those previously estimated;
- f) cancellations by aircraft of IFR flight, if these will affect levels at the holding fix or expected approach times of other aircraft;
- g) aircraft departure times or, if agreed between the two ATC units concerned, the estimated time at the control area boundary or other specified point;
- h) all available information relating to overdue or unreported aircraft;
- i) missed approaches which may affect the ACC.

10.1.3.3.2 The ACC shall keep the unit providing approach control service promptly advised of pertinent data on controlled traffic such as:

- a) identification, type and point of departure of arriving aircraft;
- b) estimated time and proposed level of arriving aircraft over holding fix or other specified point;
- c) actual time and proposed level of arriving aircraft over holding fix if aircraft is released to the unit providing approach control service after arrival over the holding fix;
- d) requested type of IFR approach procedure if different to that specified by the approach control unit;
- e) expected approach time issued;
- f) when required, statement that aircraft has been instructed to contact the unit providing approach control service;
- g) when required, statement that an aircraft has been released to the unit providing approach control service including, if necessary, the time and conditions of release;
- h) anticipated delay to departing traffic due to congestion.

10.1.3.3.3 Information on arriving aircraft shall be forwarded not less than fifteen minutes before estimated time of arrival and such information shall be revised as necessary.

10.1.4 Coordination between a unit providing approach control service and a unit providing aerodrome control service

10.1.4.1 DIVISION OF CONTROL

10.1.4.1.1 A unit providing approach control service shall retain control of arriving aircraft until such aircraft have been transferred to the aerodrome control tower and are in communication with the aerodrome control tower. Letters of agreement or local instructions, appropriate to the airspace structure, terrain, meteorological conditions and ATS facilities available, shall establish rules for the transfer of arriving aircraft.

10.1.4.1.2 A unit providing approach control service may authorize an aerodrome control tower to release an aircraft for take-off subject to the discretion of the aerodrome control tower with respect to arriving aircraft.

10.1.4.1.3 Aerodrome control towers shall, when so prescribed in letters of agreement or local instructions, obtain approval from the unit providing approach control service prior to authorizing operation of special VFR flights.

10.1.4.2 EXCHANGE OF MOVEMENT AND CONTROL DATA

10.1.4.2.1 An aerodrome control tower shall keep the unit providing approach control service promptly advised of pertinent data on relevant controlled traffic such as:

- a) arrival and departure times;
- b) when required, statement that the first aircraft in an approach sequence is in communication with and is sighted by the aerodrome control tower, and that reasonable assurance exists that a landing can be accomplished;
- c) all available information relating to overdue or unreported aircraft;
- d) information concerning missed approaches;
- e) information concerning aircraft that constitute essential local traffic to aircraft under the control of the unit providing approach control service.

10.1.4.2.2 The unit providing approach control service shall keep the aerodrome control tower promptly advised of pertinent data on controlled traffic such as:

- a) estimated time and proposed level of arriving aircraft over the aerodrome, at least fifteen minutes prior to estimated arrival;

- b) when required, a statement that an aircraft has been instructed to contact the aerodrome control tower and that control shall be assumed by that unit;
- c) anticipated delay to departing traffic due to congestion.

10.1.5 Coordination between control positions within the same unit

10.1.5.1 Appropriate flight plan and control information shall be exchanged between control positions within the same air traffic control unit, in respect of:

- a) all aircraft for which responsibility for control will be transferred from one control position to another;
- b) aircraft operating in such close proximity to the boundary between control sectors that control of traffic within an adjacent sector may be affected;
- c) all aircraft for which responsibility for control has been delegated by a controller using procedural methods to a controller using an ATS surveillance system, as well as other aircraft affected.

10.1.5.2 Procedures for coordination and transfer of control between control sectors within the same ATC unit shall conform to the procedures applicable to ATC units.

10.1.6 Failure of automated coordination

The failure of automated coordination shall be presented clearly to the controller responsible for coordinating the flight at the transferring unit. This controller shall then facilitate the required coordination using prescribed alternative methods.

10.2 COORDINATION IN RESPECT OF THE PROVISION OF FLIGHT INFORMATION SERVICE AND ALERTING SERVICE

10.2.1 Where this is deemed necessary by the ANSP, coordination between ATS units providing flight information service in adjacent FIRs shall be effected in respect of IFR and VFR flights, in order to ensure continued flight information service to such aircraft in specified areas or along specified routes. Such coordination shall be effected in accordance with an agreement between the ATS units concerned.

10.2.2 Where coordination of flights is effected in accordance with 10.2.1, this shall include transmission of the following information on the flight concerned:

- a) appropriate items of the current flight plan; and
- b) the time at which last contact was made with the aircraft concerned.

10.2.3 This information shall be forwarded to the ATS unit in charge of the next FIR in which the aircraft will operate prior to the aircraft entering such FIR.

10.2.4 When so required by agreement between the appropriate ATS authorities to assist in the identification of strayed or unidentified aircraft and thereby eliminate or reduce the need for interception, flight plan and flight progress information for flights along specified routes or portions of routes in close proximity to FIR boundaries shall also be provided to the ATS units in charge of the FIRs adjacent to such routes or portions of routes.

10.2.5 In circumstances where an aircraft has declared minimum fuel or is experiencing an emergency, or in any other situation wherein the safety of the aircraft is not assured, the type of emergency and/or the circumstances experienced by the aircraft shall be reported by the transferring unit to the accepting unit and any other ATS unit that may be concerned with the flight and to the associated rescue coordination centres, if necessary.

10.3 COORDINATION IN RESPECT OF THE PROVISION OF AIR TRAFFIC ADVISORY SERVICE

Note: This section is reserved.

10.4 COORDINATION BETWEEN AIR TRAFFIC SERVICES UNITS AND AERONAUTICAL TELECOMMUNICATION STATIONS

10.4.1 When so prescribed by the ANSP, ATS units shall ensure that the aeronautical telecommunications stations serving the centres concerned are informed regarding transfers of communications contact by aircraft. Unless otherwise provided, information to be made available shall comprise the identification of the aircraft (including SELCAL code, when necessary), the route or destination (where necessary), and the expected or actual time of communications transfer.

10.5 COORDINATION BETWEEN THE AIR / AERODROME OPERATOR AND AIR TRAFFIC SERVICES

10.5.1 Air traffic services units, in carrying out their objectives, shall have due regard for the requirements of the operators. If so required by the operators, the ANSP shall make available to them or their designated representatives such information as may be available to enable them or their designated representatives to carry out their responsibilities.

10.6 COORDINATION BETWEEN METEOROLOGICAL AND AIR TRAFFIC SERVICES AUTHORITIES

10.6.1 Air traffic services units shall be supplied with up-to-date information on existing and forecast meteorological conditions as necessary for the performance of their respective functions. The information shall be supplied in such a form as to require a minimum of interpretation on the part of air traffic services personnel and with a frequency which satisfies the requirements of the air traffic services units concerned. To ensure that aircraft receive the most up-to-date meteorological information for aircraft operations, the coordination between meteorological and air traffic services authorities shall be effected in accordance with the provisions of ICAO Annex 11, Chapter 7.

10.7 COORDINATION BETWEEN AERONAUTICAL INFORMATION SERVICES AND AIR TRAFFIC SERVICES AUTHORITIES

10.7.1 To ensure that aeronautical information services units obtain information to enable them to provide up-to-date pre-flight information and to meet the need for in-flight information, the coordination between aeronautical information services and air traffic services authorities shall be properly effected. In addition, aeronautical information/data to the aeronautical information services shall take into account accuracy and integrity requirements for aeronautical data. The correct use of the common reference systems for air navigation shall be followed. The ANSP shall ensure that all these are effected in accordance with the provisions of ICAO Annex 11, Chapter 2.

CHAPTER 11

AIR TRAFFIC SERVICES MESSAGES

11.1 CATEGORIES OF MESSAGES

11.1.1 General

11.1.1.1 In accordance with the requirements in Chapter 10 — Coordination, the messages listed below are authorized for transmission via the aeronautical fixed service (including the aeronautical telecommunication network (ATN) and the aeronautical fixed telecommunication network (AFTN), direct-speech circuits or digital data interchange between ATS units, and direct teletypewriter and computer-computer circuits), or via the aeronautical mobile service, as applicable. They are classified in categories relating to their use by the air traffic services and providing an approximate indication of their importance.

Note.— The Priority Indicator in parentheses after each type of message is that specified in ICAO Annex 10 (Volume II, Chapter 4) for application when the message is transmitted on the AFTN.

11.1.2 Emergency messages

11.1.2.1 This category comprises:

- a) distress messages and distress traffic, including messages relating to a distress phase (SS);
- b) urgency messages, including messages relating to an alert phase or to an uncertainty phase (DD);
- c) other messages concerning known or suspected emergencies which do not fall under a) or b) above, and radio-communication failure messages (FF or higher as required).

Note.— When the messages in a) and b) and, if required, in c) above are filed with the public telecommunication service, the Priority Indicator SVH, assigned to telegrams relating to the safety of life, is to be used in accordance with Article 25 of the International Telecommunication Convention, Malaga, 1973.

11.1.3 Movement and control messages

11.1.3.1 This category comprises:

- a) movement messages (FF), including:

— filed flight plan messages

-
- delay messages
 - modification messages
 - flight plan cancellation messages
 - departure messages
 - arrival messages;
- b) coordination messages (FF), including:
- current flight plan messages
 - estimate messages
 - coordination messages
 - acceptance messages
 - logical acknowledgement messages;
- c) supplementary messages (FF), including:
- request flight plan messages
 - request supplementary flight plan messages
 - supplementary flight plan messages;
- d) control messages (FF), including:
- clearance messages
 - flow control messages
 - position-report and air-report messages.

11.1.4 Flight information messages

11.1.4.1 This category comprises:

- a) messages containing traffic information (FF);
- b) messages containing meteorological information (FF or GG);
- c) messages concerning the operation of aeronautical facilities (GG);

- d) messages containing essential aerodrome information (GG);
- e) messages concerning air traffic incident reports (FF).

11.1.4.2 When justified by the requirement for special handling, messages transmitted via the AFTN should be assigned the Priority Indicator DD in place of the normal Priority Indicator.

11.2 GENERAL PROVISIONS

Note.— The use in this Chapter of expressions such as “originated”, “transmitted”, “addressed” or “received” does not necessarily imply that reference is made to a teletypewriter or digital data interchange for a computer-to-computer message. Except where specifically indicated, the messages described in this Chapter may also be transmitted by voice, in which case the four terms above represent “initiated”, “spoken by”, “spoken to” and “listened to” respectively.

11.2.1 Origination and addressing of messages

11.2.1.1 GENERAL

Note.— Movement messages in this context comprise flight plan messages, departure messages, delay messages, arrival messages, cancellation messages and position report messages and modification messages relevant thereto.

11.2.1.1.1 Messages for air traffic services purposes shall be originated by the appropriate air traffic services units or by aircraft as specified in Section 11.3, except that, through special local arrangements, air traffic services units may delegate the responsibility for originating movement messages to the pilot, the operator, or its designated representative.

11.2.1.1.2 Origination of movement, control and flight information messages for purposes other than air traffic services (e.g. operational control) shall, except as provided for in ICAO Annex 11, 2.15, be the responsibility of the pilot, the operator, or a designated representative.

11.2.1.1.3 Flight plan messages, amendment messages related thereto and flight plan cancellation messages shall, except as provided in 11.2.1.1.4, be addressed only to those air traffic services units which are specified in the provisions of 11.4.2. Such messages shall be made available to other air traffic services units concerned, or to specified positions within such units and to any other addressees of the messages, in accordance with local arrangements.

11.2.1.1.4 When so requested by the operator concerned, emergency and movement messages which are to be transmitted simultaneously to air traffic services units concerned, shall also be addressed to:

- a) one addressee at the destination aerodrome or departure aerodrome, and
- b) not more than two operational control units concerned, such addressees to be specified by the operator or its designated representative.

11.2.1.1.5 When so requested by the operator concerned, movement messages transmitted progressively between air traffic services units concerned and relating to aircraft for which operational control service is provided by that operator shall, so far as practicable, be made available immediately to the operator or its designated representative in accordance with agreed local procedures.

11.2.1.2 USE OF THE AFTN

11.2.1.2.1 Air traffic services messages to be transmitted via the AFTN shall contain:

a) information in respect of the priority with which it is to be transmitted and the addressees to whom it is to be delivered, and an indication of the date and time at which it is filed with the aeronautical fixed station concerned and of the Originator Indicator (see 11.2.1.2.5);

b) the air traffic services data, preceded if necessary by the supplementary address information described in 11.2.1.2.6, and prepared in accordance with **Appendix 3**. These data will be transmitted as the text of the AFTN message.

11.2.1.2.2 PRIORITY INDICATOR

11.2.1.2.2.1 This shall consist of the appropriate two-letter Priority Indicator for the message as shown in parentheses for the appropriate category of message in Section 11.1.

Note.— It is prescribed in ICAO Annex 10 (Vol. II, Chapter 4) that the order of priority for the transmission of messages in the AFTN shall be as follows:

<i>Transmission Priority</i>	<i>Priority Indicator</i>
1	SS
2	DD FF
3	GG KK

11.2.1.2.3 ADDRESS

11.2.1.2.3.1 This shall consist of a sequence of Addressee Indicators, one for each addressee to whom the message is to be delivered.

11.2.1.2.3.2 Each Addressee Indicator shall consist of an eight-letter sequence comprising, in the following order:

a) the ICAO four-letter Location Indicator assigned to the place of destination;

Note.— A list of ICAO Location Indicators is contained in Doc 7910 — Location Indicators.

b) i) the ICAO three-letter designator identifying the aeronautical authority service or aircraft operating agency addressed, or

ii) in cases where no designator has been assigned, one of the following:

- “YXY” in the case where the addressee is a military service/organization,
- “ZZZ” in the case where the addressee is an aircraft in flight,
- “YYY” in all other cases;

Note.— A list of ICAO three-letter designators is contained in Doc 8585 — Designators for Aircraft Operating Agencies, Aeronautical Authorities and Services.

c) i) the letter X, or

ii) the one-letter designator identifying the department or division of the organization addressed.

11.2.1.2.3.3 The following three-letter designators shall be used when addressing ATS messages to ATS units: Centre in charge of a Flight Information Region or an Upper Flight Information Region (whether ACC or FIC):

— if the message is relevant to an IFR flight	ZQZ
— if the message is relevant to a VFR flight	ZFZ
Aerodrome Control Tower	ZTZ
Air Traffic Services Reporting Office	ZPZ

Other three-letter designators for ATS units shall not be used for that purpose.

11.2.1.2.4 *FILING TIME*

The filing time shall consist of a six-digit date-time group indicating the date and the time of filing the message for transmission with the aeronautical fixed station concerned.

11.2.1.2.5 *ORIGINATOR INDICATOR*

The Originator Indicator shall consist of an eight-letter sequence, similar to an Addressee Indicator (see 11.2.1.2.3.2), identifying the place of origin and the organization originating the message.

11.2.1.2.6 *SUPPLEMENTARY INFORMATION ON THE ADDRESS AND THE ORIGIN*

11.2.1.2.6.1 The following supplementary information is required when, in the Indicators of the Address and/or Origin, the three-letter designators “YXY”, “ZZZ” or “YYY” [see 11.2.1.2.3.2 b) ii)] are used:

- a) the name of the organization or the identity of the aircraft concerned is to appear at the beginning of the text;
- b) the order of such insertions is to be the same as the order of the Addressee Indicators and/or the Originator Indicator;
- c) where there are more than one such insertion, the last should be followed by the word “STOP”;
- d) where there are one or more insertions in respect of Addressee Indicators plus an insertion in respect of the Originator Indicator, the word “FROM” is to appear before that relating to the Originator Indicator.

Note.— Regarding ATS messages received in teletypewriter page-copy form:

- 1) *ATS messages received via the AFTN will have been placed within a communications “envelope” (preceding and following character sequences which are necessary to ensure correct transmission via the AFTN). Even the text of the AFTN message may be received with words or groups preceding and following the ATS text.*
- 2) *The ATS message may then be located by the simple rule that it is preceded by an Open Bracket, e.g., ‘(’ and followed by a Close Bracket, e.g., ‘)’.*
- 3) *In some local cases, the teletypewriter machines in use will always print two specific symbols other than Open Bracket and Close Bracket on receipt of ATS messages constructed as prescribed in **Appendix 3**. Such local variants are easily learned and are of no consequence.*

11.2.2 Preparation and transmission of messages

11.2.2.1 ATS messages shall be prepared and transmitted with standard texts in a standard format and in accordance with standard data conventions, as and when prescribed in **Appendix 3**.

11.2.2.2 When messages are exchanged orally between the relevant ATS units, an oral acknowledgement shall constitute evidence of receipt of the message. No confirmation in written form directly between controllers shall therefore be required. The confirmation of coordination via the exchange of messages between automated systems shall be required unless special arrangements have been made between the units concerned.

Note.— See ICAO Annex 11, Chapter 6, regarding the requirement for recording of direct-speech communications.

11.3 METHODS OF MESSAGE EXCHANGE

11.3.1 The lead-time requirements of air traffic control and flow control procedures shall determine the method of message exchange to be used for the exchange of ATS data.

11.3.1.1 The method of message exchange shall also be dependent upon the availability of adequate communications channels, the function to be performed, the types of data to be exchanged and the processing facilities at the centres concerned.

11.3.2 Basic flight plan data necessary for flow control procedures shall be furnished at least 60 minutes in advance of the flight. Basic flight plan data shall be provided by either a filed flight plan or a repetitive flight plan submitted by mail in the form of a repetitive flight plan listing form or other media suitable for electronic data processing systems.

11.3.2.1 Flight plan data submitted in advance of flight shall be updated by time, level and route changes and other essential information as may be necessary.

11.3.3 Basic flight plan data necessary for air traffic control purposes shall be furnished to the first en-route control centre at least 30 minutes in advance of the flight, and to each successive centre at least 20 minutes before the aircraft enters that centre's area of jurisdiction, in order for it to prepare for the transfer of control.

11.3.4 Except as provided for in 11.3.5, the second en-route centre and each successive centre shall be provided with current data, including updated basic flight plan data, contained in a current flight plan message or in an estimate message supplementing already available updated basic flight plan data.

11.3.5 In areas where automated systems are utilized for the exchange of flight plan data and where these systems provide data for several ACCs, approach control units and/or aerodrome control towers, the appropriate messages shall not be addressed to each individual ATS unit, but only to these automated systems.

Note. — Further processing and distribution of the data to its associated ATS units is the internal task of the receiving system.

11.3.6 Movement messages

11.3.6.1 Movement messages shall be addressed simultaneously to the first en-route control centre, to all other ATS units along the route of flight which are unable to obtain or process current flight plan data, and to air traffic flow management units concerned.

11.3.7 Coordination and transfer data

11.3.7.1 Progression of a flight between successive control sectors and/or control centres shall be effected by a coordination and transfer dialogue comprising the following stages:

- a) notification of the flight in order to prepare for coordination as necessary;
- b) coordination of conditions of transfer of control by the transferring ATC unit;

- c) coordination, if necessary, and acceptance of conditions of transfer of control by the accepting ATC unit; and
- d) the transfer of control to the accepting unit.

11.3.7.2 The notification of the flight shall be by a current flight plan message containing all relevant ATS data or by an estimate message containing the proposed conditions of transfer. An estimate message shall be used only when updated basic flight plan data is already available at the receiving unit, i.e. a filed flight plan message and associated update message(s) have already been sent by the transferring unit.

11.3.7.3 The coordination dialogue shall be considered to be completed as soon as the proposed conditions contained in the current flight plan message, or in the estimate message or in one or more counterproposals, are accepted by an operational or logical procedure.

11.3.7.4 Unless an operational acknowledgement is received, a Logical Acknowledgement message shall be automatically transmitted by the receiving computer in order to ensure the integrity of the coordination dialogue employing computer-to-computer links. This message shall be transmitted when the transfer data has been received and processed to the point that it is considered free of syntactic and semantic errors, i.e. the message contains valid information.

11.3.7.5 The transfer of control shall be either explicit or, by agreement between the two units concerned, implicit, i.e. no communication need be exchanged between the transferring and accepting units.

11.3.7.6 When the transfer of control involves exchange of data, the proposal for transfer shall include information derived from an ATS surveillance system, if appropriate. Since the proposal relates to previously accepted coordination data, further coordination shall normally not be required. However, acceptance of the proposed transfer conditions shall be required.

11.3.7.7 In situations where the proposed transfer conditions are no longer acceptable to the accepting unit, further coordination shall be initiated by the accepting unit by proposing alternative acceptable conditions.

11.3.7.8 Transfer of Communication messages may be used as an alternative to Transfer of Control messages. If Transfer of Communication messages are used to instruct a flight to establish communications with the receiving unit and the transfer of control will take place at the control area boundary, or such other time or place, specified in letters of agreement, Transfer of Control messages need not be used.

11.3.7.9 If, after receipt of information derived from an ATS surveillance system, the accepting centre is unable to identify the aircraft immediately, additional communication shall ensue to obtain new surveillance information, if appropriate.

11.3.7.10 When control of the transferred aircraft has been assumed, the accepting unit shall complete the transfer of control dialogue by communicating assumption of control to the transferring unit, unless special arrangements have been made between the units concerned.

11.3.8 Supplementary data

11.3.8.1 When basic flight plan data or supplementary flight plan data are required, request messages shall be addressed to the ATS unit which is most likely to have access to the required data.

Note.— See 11.4.2.4.2 and 11.4.2.4.3 for ATS units to which request messages shall be addressed.

11.3.8.2 If the requested information is available, a filed or a supplementary flight plan message shall be transmitted.

11.4 MESSAGE TYPES AND THEIR APPLICATION

11.4.1 Emergency messages

11.4.1.1 The various circumstances surrounding each known or suspected emergency situation preclude the specification of standard message types to provide for emergency communications, except as described in 11.4.1.2, 11.4.1.3 and 11.4.1.4.

11.4.1.2 ALERTING (ALR) MESSAGES

11.4.1.2.1 When an ATS unit considers that an aircraft is in a state of emergency as defined in ICAO Annex 11, Chapter 5, an alerting message shall be transmitted to any ATS unit that may be concerned with the flight and to the associated rescue coordination centres, containing such of the information specified in **Appendix 3**, Section 1, as is available or can be obtained.

11.4.1.2.2 When so agreed between the ATS units concerned, a communication relating to an emergency phase and originated by a unit employing automatic data-processing equipment may take the form of a modification message (as in 11.4.2.2.4) or a coordination message (as in 11.4.2.3.4 or 11.4.2.4.4), supplemented by a verbal message giving the additional details prescribed for inclusion in an alerting message.

11.4.1.3 RADIOCOMMUNICATION FAILURE (RCF) MESSAGES

Note.— Provisions governing the action to be taken in the event of radio communication failure are set forth in ICAO Annex 2, 3.6.5.2, and in Chapter 15, Section 15.6 of this document.

11.4.1.3.1 When an ATS unit is aware that an aircraft in its area is experiencing radio communication failure, an RCF message shall be transmitted to all subsequent ATS units along the route of flight which have already received basic flight plan data (FPL

or RPL) and to the aerodrome control tower at the destination aerodrome, if basic flight plan data has been previously sent.

11.4.1.3.2 If the next ATS unit has not yet received basic flight plan data because it would receive a current flight plan message in the coordination procedure, then an RCF message and a current flight plan (CPL) message shall be transmitted to this ATS unit. In turn, this ATS unit shall transmit an RCF message and a CPL message to the next ATS unit.

11.4.1.4 FREE TEXT EMERGENCY MESSAGES (AIDC, APPENDIX 6 REFERS)

Note: This section is reserved.

11.4.2 Movement and control messages

11.4.2.1 GENERAL

11.4.2.1.1 Messages concerning the intended or actual movement of aircraft shall be based on the latest information furnished to ATS units by the pilot, the operator or its designated representative, or derived from an ATS surveillance system.

11.4.2.2 MOVEMENT MESSAGES

11.4.2.2.1 Movement messages comprise:

- filed flight plan messages (11.4.2.2.2)
- delay messages (11.4.2.2.3)
- modification messages (11.4.2.2.4)
- flight plan cancellation messages (11.4.2.2.5)
- departure messages (11.4.2.2.6)
- arrival messages (11.4.2.2.7).

11.4.2.2.2 FILED FLIGHT PLAN (FPL) MESSAGES

Note.— Instructions for the transmission of an FPL message are contained in **Appendix 2**.

11.4.2.2.2.1 Unless repetitive flight plan procedures are being applied or current flight plan messages are being employed, filed flight plan messages shall be transmitted for all flights for which a flight plan has been submitted with the object of being provided with air traffic control service, flight information service or alerting service along part or the whole of the route of flight.

11.4.2.2.2.2 A filed flight plan message shall be originated and addressed as follows by the ATS unit serving the departure aerodrome or, when applicable, by the ATS unit receiving a flight plan from an aircraft in flight:

- a) an FPL message shall be sent to the ACC or flight information centre serving the control area or FIR within which the departure aerodrome is situated;
- b) unless basic flight plan data are already available as a result of arrangements made for repetitive flight plans, an FPL message shall be sent to all centres in charge of each FIR or upper FIR along the route which are unable to process current data. In addition, an FPL message shall be sent to the aerodrome control tower at the destination aerodrome. If so required, an FPL message shall also be sent to flow management centres responsible for ATS units along the route;
- c) when a potential reclearance in flight (RIF) request is indicated in the flight plan, the FPL message shall be sent to the additional centres concerned and to the aerodrome control tower of the revised destination aerodrome;
- d) where it has been agreed to use CPL messages but where information is required for early planning of traffic flow, an FPL message shall be transmitted to the ACCs concerned;
- e) for a flight along routes where flight information service and alerting service only are provided, an FPL message shall be addressed to the centre in charge of each FIR or upper FIR along the route and to the aerodrome control tower at the destination aerodrome.

11.4.2.2.2.3 In the case of a flight through intermediate stops, where flight plans for each stage of the flight are filed at the first departure aerodrome, the following procedure shall be applied:

- a) the air traffic services reporting office at the first departure aerodrome shall:
 - 1) transmit an FPL message for the first stage of flight in accordance with 11.4.2.2.2.2;
 - 2) transmit a separate FPL message for each subsequent stage of flight, addressed to the air traffic services reporting office at the appropriate subsequent departure aerodrome;
- b) the air traffic services reporting office at each subsequent departure aerodrome shall take action on receipt of the FPL message as if the flight plan has been filed locally.

11.4.2.2.2.4 When so required by agreement between the appropriate ATS units to assist in the identification of flights and thereby eliminate or reduce the need for interceptions in the event of deviations from assigned track, FPL messages for flights along specified routes or portions of routes in close proximity to FIR boundaries shall

also be addressed to the centres in charge of each FIR or upper FIR adjacent to such routes or portions of routes.

11.4.2.2.2.5 FPL messages shall normally be transmitted immediately after the filing of the flight plan. However, if a flight plan is filed more than 24 hours in advance of the estimated off-block time of the flight to which it refers, that flight plan shall be held in abeyance until at most 24 hours before the flight begins so as to avoid the need for the insertion of a date group into that flight plan. In addition, if a flight plan is filed early and the provisions of 11.4.2.2.2.2 b) or e) or 11.4.2.2.2.3 apply, transmission of the FPL message may be withheld until one hour before the estimated off-block time, provided that this will permit each ATS unit concerned to receive the information at least 30 minutes before the time at which the aircraft is estimated to enter its area of responsibility.

11.4.2.2.3 *DELAY (DLA) MESSAGES*

11.4.2.2.3.1 A DLA message shall be transmitted when the departure of an aircraft, for which basic flight plan data (FPL or RPL) has been sent, is delayed by more than 30 minutes after the estimated off-block time contained in the basic flight plan data.

11.4.2.2.3.2 The DLA message shall be transmitted by the ATS unit serving the departure aerodrome to all recipients of basic flight plan data.

Note. — See 11.4.2.3.4 concerning notification of a delayed departure of an aircraft for which a CPL message has been transmitted.

11.4.2.2.4 *MODIFICATION (CHG) MESSAGES*

11.4.2.2.4.1 A CHG message shall be transmitted when any change is to be made to basic flight plan data contained in previously transmitted FPL or RPL data. The CHG message shall be sent to those recipients of basic flight plan data which are affected by the change.

Note. — See 11.4.2.3.4 concerning notification of a change to coordination data contained in a previously transmitted current flight plan or estimate message.

11.4.2.2.5 *FLIGHT PLAN CANCELLATION (CNL) MESSAGES*

11.4.2.2.5.1 A flight plan cancellation (CNL) message shall be transmitted when a flight, for which basic flight plan data has been previously distributed, has been cancelled. The ATS unit serving the departure aerodrome shall transmit the CNL message to ATS units which have received basic flight plan data.

11.4.2.2.6 *DEPARTURE (DEP) MESSAGES*

11.4.2.2.6.1 Unless otherwise prescribed on the basis of regional air navigation agreements, a DEP message shall be transmitted immediately after the departure of an aircraft for which basic flight plan data have been previously distributed.

11.4.2.2.6.2 The DEP message shall be transmitted by the ATS unit serving the departure aerodrome to all recipients of basic flight plan data.

Note. — See 11.4.2.3.4 concerning notification of the departure of an aircraft for which a CPL message has been transmitted.

11.4.2.2.7 ARRIVAL (ARR) MESSAGES

11.4.2.2.7.1 When an arrival report is received by the ATS unit serving the arrival aerodrome, this unit shall transmit an ARR message:

a) for a landing at the destination aerodrome:

1) to the ACC or flight information centre in whose area the arrival aerodrome is located, if required by that unit; and

2) to the ATS unit, at the departure aerodrome, which originated the flight plan message, if that message included a request for an ARR message;

b) for a landing at an alternate or other aerodrome:

1) to the ACC or flight information centre in whose area the arrival aerodrome is located; and

2) to the aerodrome control tower at the destination aerodrome; and

3) to the air traffic services reporting office at the departure aerodrome; and

4) to the ACC or flight information centre in charge of each FIR or upper FIR through which the aircraft would have passed according to the flight plan, had it not diverted.

11.4.2.2.7.2 When a controlled flight which has experienced failure of two-way communication has landed, the aerodrome control tower at the arrival aerodrome shall transmit an ARR message:

a) for a landing at the destination aerodrome:

1) to all ATS units concerned with the flight during the period of the communication failure; and

2) to all other ATS units which may have been alerted;

b) for a landing at an aerodrome other than the destination aerodrome:

to the ATS unit serving the destination aerodrome; this unit shall then transmit an ARR message to other ATS units concerned or alerted as in a) above.

11.4.2.3 COORDINATION MESSAGES (**APPENDIX 3 REFERS**)

Note.— The provisions governing coordination are contained in Chapter 10. Phraseology to be used in voice communication is contained in Chapter 12.

11.4.2.3.1 Coordination messages comprise:

- current flight plan messages (11.4.2.3.2)
- estimate messages (11.4.2.3.3)
- coordination messages (11.4.2.3.4)
- acceptance messages (11.4.2.3.5)
- logical acknowledgement messages (11.4.2.3.6).

11.4.2.3.2 *CURRENT FLIGHT PLAN (CPL) MESSAGES*

11.4.2.3.2.1 Unless basic flight plan data have already been distributed (FPL or RPL) which will be supplemented by coordination data in the estimate message, a CPL message shall be transmitted by each ACC to the next ACC and from the last ACC to the aerodrome control tower at the destination aerodrome, for each controlled flight along routes or portions of routes where it has been determined by the appropriate ATS unit that adequate point-to-point communications exist and that conditions are otherwise suitable for forwarding current flight plan information.

11.4.2.3.2.2 When an aircraft traverses a very limited portion of a control area where, by agreement between the appropriate ATS units concerned, coordination of air traffic through that portion of the control area has been delegated to and is effected directly by the two centres whose control areas are separated by that portion, CPLs shall be transmitted directly between such units.

11.4.2.3.2.3 A CPL message shall be transmitted in sufficient time to permit each ATS unit concerned to receive the information at the time at which the aircraft is estimated to pass the transfer of control point or boundary point at which it comes under the control of such unit, unless another period of time has been prescribed by the appropriate ATS unit. This procedure shall apply whether or not the ATS unit responsible for origination of the message has assumed control of, or established contact with, the aircraft by the time the transmission is to be effected.

11.4.2.3.2.4 When a CPL message is transmitted to a centre which is not using automatic data processing equipment, the period of time specified in 11.4.2.3.2.3 may be insufficient, in which case an increased lead-time shall be agreed.

11.4.2.3.2.5 A CPL message shall include only information concerning the flight from the point of entry into the next control area or advisory airspace to the destination aerodrome.

11.4.2.3.3 *ESTIMATE (EST) MESSAGES*

11.4.2.3.3.1 When basic flight plan data for a flight has been provided, an EST message shall be transmitted by each ACC or flight information centre to the next ACC or flight information centre along the route of flight.

11.4.2.3.3.2 An EST message shall be transmitted in sufficient time to permit the ATS unit concerned to receive the information at least 20 minutes before the time at which the aircraft is estimated to pass the transfer of control point or boundary point at which it comes under the control of such unit, unless another period of time has been prescribed by the ANSP. This procedure shall apply whether or not the ACC or flight information centre responsible for origination of the message has assumed control of, or established contact with, the aircraft by the time the transmission is to be effected.

11.4.2.3.3.3 When an EST message is transmitted to a centre which is not using automatic data processing equipment, the period of time 11.4.2.3.3.2 may be insufficient, in which case an increased lead-time shall be agreed.

11.4.2.3.4 *COORDINATION (CDN) MESSAGES*

11.4.2.3.4.1 A CDN message shall be transmitted during the coordination dialogue by an accepting unit to the transferring unit when the former wishes to propose a change to coordination data as contained in a previously received CPL or EST message.

11.4.2.3.4.2 If the transferring unit wishes to propose a change to the data contained in a CDN message received from the accepting unit, a CDN message shall be transmitted to the accepting unit.

11.4.2.3.4.3 The dialogue described above is repeated until the coordination dialogue is completed by the transmission of an acceptance (ACP) message by one of the two units concerned. Normally, however, when a change is proposed to a CDN message, direct-speech circuits shall be used to resolve this issue.

11.4.2.3.4.4 After the coordination dialogue has been completed, if one of the two ATS units concerned wishes to propose or notify any change in basic flight plan data or conditions of transfer, a CDN message shall be transmitted to the other unit. This requires that the coordination dialogue be repeated.

11.4.2.3.4.5 A repeated coordination dialogue is completed by the transmission of an ACP message. Normally, in a repeated coordination dialogue, direct-speech circuits shall be used.

11.4.2.3.5 *ACCEPTANCE (ACP) MESSAGE*

11.4.2.3.5.1 Unless special arrangements have been made between the air traffic control units concerned in accordance with Chapter 10, 10.1.2.2.1, an ACP message

shall be transmitted by an accepting unit to the transferring unit to indicate that data in a CPL or an EST message is accepted.

11.4.2.3.5.2 Either the accepting unit or the transferring unit shall transmit an ACP message to indicate that data received in a CDN message is accepted and that the coordination dialogue is completed.

11.4.2.3.6 *LOGICAL ACKNOWLEDGEMENT MESSAGES (LAM)*

11.4.2.3.6.1 An LAM shall be used only between ATC computers.

11.4.2.3.6.2 An ATC computer shall transmit an LAM in response to a CPL or EST or other appropriate message which is received and processed up to the point where the operational content will be received by the appropriate controller.

11.4.2.3.6.3 The transferring centre shall set an appropriate reaction time parameter when the CPL or EST message is transmitted. If the LAM is not received within the parameter time, an operational warning shall be initiated and reversion to telephone and manual mode shall ensue.

11.4.2.4 SUPPLEMENTARY MESSAGES

11.4.2.4.1 Supplementary messages comprise:

- request flight plan messages (11.4.2.4.2)
- request supplementary flight plan messages (11.4.2.4.3)
- supplementary flight plan messages (11.4.2.4.4).

11.4.2.4.2 *REQUEST FLIGHT PLAN (RQP) MESSAGES*

11.4.2.4.2.1 A request flight plan (RQP) message shall be transmitted when an ATS unit wishes to obtain flight plan data. This might occur upon receipt of a message concerning an aircraft for which no corresponding basic flight plan data had been previously received. The RQP message shall be transmitted to the transferring ATS unit which originated an EST message, or to the centre which originated an update message for which no corresponding basic flight plan data are available. If no message has been received at all, but an aircraft establishes radiotelephony (RTF) communications and requires air traffic services, the RQP message shall be transmitted to the previous ATS unit along the route of flight.

11.4.2.4.3 *REQUEST SUPPLEMENTARY FLIGHT PLAN (RQS) MESSAGES*

11.4.2.4.3.1 A request supplementary flight plan (RQS) message shall be transmitted when an ATS unit wishes to obtain supplementary flight plan data. The message shall be transmitted to the air traffic services reporting office at the departure

aerodrome or in the case of a flight plan submitted during flight, to the ATS unit specified in the flight plan message.

11.4.2.4.4 SUPPLEMENTARY FLIGHT PLAN (SPL) MESSAGES

Note. — Instructions for the transmission of an SPL are contained in **Appendix 2**.

11.4.2.4.4.1 An SPL message shall be transmitted by the ATS reporting office at the departure aerodrome to ATS units requesting information additional to that already transmitted in a CPL or FPL message. When transmitted by the AFTN, the message shall be assigned the same priority indicator as that in the request message.

11.4.2.5 AIDC MESSAGES (APPENDIX 6 REFERS)

Note: This section is reserved.

11.4.2.6 CONTROL MESSAGES

11.4.2.6.1 Control messages comprise:

- clearance messages (11.4.2.6.2)
- flow control messages (11.4.2.6.4)
- position-report and air-report messages (11.4.2.6.5).

11.4.2.6.2 CLEARANCE MESSAGES

Note.— Provisions governing clearances are contained in Chapter 4, Section 4.5. The following paragraphs set forth the contents of clearance messages together with certain procedures relating to the transmission thereof. Procedures governing the use of CPDLC for the delivery of clearances are contained in Chapter 14. Specifications regarding the intent, message attributes and display options can be found in Appendix 5A and 5B.

11.4.2.6.2.1 Clearances shall contain the following in the order listed:

- a) aircraft identification;
- b) clearance limit;
- c) route of flight;
- d) level(s) of flight for the entire route or part thereof and changes of levels if required;

Note.— If the clearance for the levels covers only part of the route, it is important for the air traffic control unit to specify a point to which the part of the clearance regarding levels applies whenever necessary to ensure compliance with 3.6.5.2.2 a) of ICAO Annex 2.

- e) any necessary instructions or information on other matters such as SSR transponder operation, approach or departure manoeuvres, communications and the time of expiry of the clearance.

Note.— The time of expiry of the clearance indicates the time after which the clearance will be automatically cancelled if the flight has not been started.

11.4.2.6.2.2 Instructions included in clearances relating to levels shall consist of:

- a) cruising level(s) or, for cruise climb, a range of levels, and, if necessary, the point to which the clearance is valid with regard to the level(s);

Note.— See 11.4.2.6.2.1 d) and associated Note.

- b) levels at which specified significant points are to be crossed, when necessary;
- c) the place or time for starting climb or descent, when necessary;
- d) the rate of climb or descent, when necessary;
- e) detailed instructions concerning departure or approach levels, when necessary.

11.4.2.6.2.3 It is the responsibility of the aeronautical station or aircraft operator who has received the clearance to transmit it to the aircraft at the specified or expected delivery time, and to notify the air traffic control unit promptly if it is not delivered within a specified period of time.

11.4.2.6.2.4 Personnel receiving clearances for transmission to aircraft shall transmit such clearances in the exact phraseology in which they are received. In those cases where the personnel transmitting the clearances to the aircraft do not form part of the air traffic services, it is essential that appropriate arrangements be made to meet this requirement.

11.4.2.6.2.5 Level restrictions issued by ATC in air-ground communications shall be repeated in conjunction with subsequent level clearances in order to remain in effect.

Note.— See also Chapter 6, 6.3.2.4 and 6.5.2.4, regarding level restrictions published as elements of SIDs and STARs.

11.4.2.6.3 FLOW CONTROL MESSAGES

Note 1.— Provisions governing the control of air traffic flow are set forth in ICAO Annex 11, 3.7.5 and in Chapter 3, 3.2.5.2 of this document. Attention is drawn, however, to the guidance material contained in the Air Traffic Services Planning Manual (Doc 9426) regarding flow control.

Note 2.— Format and data conventions for automated interchange of flow control messages have not yet been developed.

11.4.2.6.4 POSITION-REPORT AND AIR-REPORT MESSAGES

Note.— Provisions governing position reporting are set forth in ICAO Annex 2, 3.6.3 and 5.3.3, and in Chapter 4, Sections 4.11 and 4.12 of this document.

11.4.2.6.4.1 The format and data conventions to be used in position-report and special air-report messages are those specified on the model AIREP/AIREP SPECIAL form at **Appendix 1**, using:

- a) for position-report messages: Section 1;
- b) for special air-report messages: Section 1 followed by Sections 2 and/or 3 as relevant.

11.4.2.6.4.2 Where special air-report messages transmitted by voice communications are subsequently forwarded by automatic data-processing equipment which cannot accept the special air-report message type designator ARS, the use of a different message-type designator shall be permitted by regional air navigation agreement and should be reflected in the Regional Supplementary Procedures (Doc 7030) provided that:

- a) the data transmitted accord with that specified in the special air-report format; and
- b) measures are taken to ensure that special air-report messages are forwarded to the appropriate meteorological unit and to other aircraft likely to be affected.

11.4.3 Flight information messages

11.4.3.1 MESSAGES CONTAINING TRAFFIC INFORMATION

Note.— Provisions governing the issuance of traffic information are set forth in ICAO Annex 11, 4.2.2 b) and Notes 1 and 2 and in Chapter 5, Section 5.10, and Chapter 7, Section 7.4.1 of this document.

11.4.3.1.1 MESSAGES CONTAINING TRAFFIC INFORMATION TO AIRCRAFT OPERATING OUTSIDE CONTROLLED AIRSPACE

11.4.3.1.1.1 Due to the factors influencing the nature of the flight information services, and particularly the question of provision of information on possible collision hazards to aircraft operating outside controlled airspace, it is not possible to specify standard texts for these messages.

11.4.3.1.1.2 Where such messages are transmitted they shall, however, contain sufficient data on the direction of flight and the estimated time, level and point at which the aircraft involved in the possible collision hazard will pass, overtake or approach each other. This information shall be given in such a way that the pilot of each aircraft concerned is able to appreciate clearly the nature of the hazard.

11.4.3.1.2 MESSAGES CONTAINING ESSENTIAL TRAFFIC INFORMATION TO IFR FLIGHTS OUTSIDE CONTROLLED AIRSPACE

Whenever such messages are transmitted they shall contain the following text:

- a) identification of the aircraft to which the information is transmitted;
- b) the words TRAFFIC IS or ADDITIONAL TRAFFIC IS;
- c) direction of flight of aircraft concerned;
- d) type of aircraft concerned;
- e) cruising level of aircraft concerned and ETA for the significant point nearest to where the aircraft will cross levels.

11.4.3.1.3 MESSAGES CONTAINING ESSENTIAL LOCAL TRAFFIC INFORMATION

Whenever such messages are transmitted they shall contain the following text:

- a) identification of the aircraft to which the information is transmitted;
- b) the words TRAFFIC IS or ADDITIONAL TRAFFIC IS, if necessary;
- c) description of the essential local traffic in terms that will facilitate recognition of it by the pilot, e.g. type, speed category and/or colour of aircraft, type of vehicle, number of persons;
- d) position of the essential local traffic relative to the aircraft concerned, and direction of movement.

11.4.3.2 MESSAGES CONTAINING METEOROLOGICAL INFORMATION

Note.— Provisions governing the making and reporting of aircraft observations are contained in ICAO Annex 3. Provisions concerning the contents and transmission of air-reports are contained in Chapter 4, Section 4.12 of this document, and the special air-report of volcanic activity form used for reports of volcanic activity is shown in Appendix 1 to this document. The transmission by ATS units, to meteorological offices, of meteorological information received from aircraft in flight is governed by provisions in Chapter 4, Section 4.12.6 of this document. Provisions governing the transmission by ATS units of meteorological information to aircraft are set forth in ICAO Annex 11, 4.2 and in this document (see Chapter 4, 4.8.3 and 4.10.4; Chapter 6, Sections 6.4 and 6.6; Chapter 7, 7.4.1; and Chapter 9, 9.1.3). The written forms of SIGMET messages and other plain-language meteorological messages are governed by the provisions of ICAO Annex 3.

11.4.3.2.1 Information to a pilot changing from IFR flight to VFR flight where it is likely that flight in VMC cannot be maintained shall be given in the following manner:

“INSTRUMENT METEOROLOGICAL CONDITIONS REPORTED (or forecast) IN THE VICINITY OF (location)”.

11.4.3.2.2 Meteorological information concerning the meteorological conditions at aerodromes, to be transmitted to aircraft by the ATS unit concerned, in accordance with ICAO Annex 11, Chapter 4 and this document, Chapter 6, Sections 6.4 and 6.6

and Chapter 7, Section 7.3.1, shall be extracted by the ATS unit concerned from the following meteorological messages, provided by the appropriate meteorological office, supplemented for arriving and departing aircraft, as appropriate, by information from displays relating to meteorological sensors (in particular, those related to the surface wind and runway visual range) located in the ATS units:

- a) local meteorological routine and special reports;
- b) METAR/SPECI, for dissemination to other aerodromes beyond the aerodrome of origin (mainly intended for flight planning, VOLMET broadcasts and D-VOLMET).

11.4.3.2.3 The meteorological information referred to in 11.4.3.2.2 shall be extracted, as appropriate, from meteorological reports providing information on the following elements:

- a) mean surface wind direction and speed and significant variations therefrom;

Note — Information on surface wind direction provided to ATS units by the associated meteorological office is referenced to degrees true North. Information on surface wind direction obtained from the ATS surface wind indicator and passed to pilots by ATS units is given in degrees magnetic.

- b) visibility, including significant directional variations;
- c) runway visual range (RVR);
- d) present weather;
- e) amount and height of base of low cloud;
- f) air temperature and dew-point temperature;
- g) altimeter setting(s); and
- h) supplementary information.

Note. — Provisions relating to meteorological information to be provided in accordance with 11.4.3.2.3 are contained in ICAO Annex 3 — Meteorological Service for International Air Navigation Chapter 4 and Appendix 3.

11.4.3.3 MESSAGES CONCERNING THE OPERATION OF AERONAUTICAL FACILITIES

Note — General provisions concerning this subject are set forth in ICAO Annex 11, 4.2.

11.4.3.3.1 Messages concerning the operation of aeronautical facilities shall be transmitted to aircraft from whose flight plan it is apparent that the operation of the flight may be affected by the operating status of the operating facility concerned. They shall contain appropriate data on the service status of the facility in question, and, if the facility is out of operation, an indication when the normal operating status will be restored.

11.4.3.4 MESSAGES CONTAINING INFORMATION ON AERODROME CONDITIONS

Note — Provisions regarding the issuance of information on aerodrome conditions are contained in Chapter 7, 7.4.

11.4.3.4.1 Whenever information is provided on aerodrome conditions, this shall be done in a clear and concise manner so as to facilitate appreciation by the pilot of the situation described. It shall be issued whenever deemed necessary by the controller on duty in the interest of safety, or when requested by an aircraft. If the information is provided on the initiative of the controller, it shall be transmitted to each aircraft concerned in sufficient time to enable the pilot to make proper use of the information.

11.4.3.4.2 Information that water is present on a runway shall be transmitted to each aircraft concerned, on the initiative of the controller, using the following terms:

DAMP — the surface shows a change of colour due to moisture.

WET — the surface is soaked but there is no standing water.

WATER PATCHES — patches of standing water are visible.

FLOODED — extensive standing water is visible.

11.4.3.5 MESSAGES CONCERNING AIR TRAFFIC INCIDENT REPORTS

11.4.3.5.1 When an aircraft involved in an incident has a destination outside the area of responsibility of the ATS unit where the incident occurred, the ATS unit at the destination aerodrome should be notified and requested to obtain the pilot's report. The following information should be included in the message:

- a) type of incident (AIRPROX, procedure or facility);
- b) identification of the aircraft concerned;
- c) time and position at time of incident;
- d) brief details of incident.

CHAPTER 12

PHRASEOLOGIES

12.1 COMMUNICATIONS PROCEDURES

12.1.1 The communications procedures shall be in accordance with Volume II of ICAO Annex 10 — *Aeronautical Telecommunications*, and pilots, ATS personnel and other ground personnel shall be thoroughly familiar with the radiotelephony procedures contained therein.

12.2 GENERAL

Note — Requirements for read-back of clearances and safety-related information are provided in Chapter 4, 4.5.7.5.

12.2.1 Most phraseologies contained in Section 12.3 of this Chapter show the text of a complete message without call signs. They are not intended to be exhaustive, and when circumstances differ, pilots, ATS personnel and other ground personnel will be expected to use plain language, which should be as clear and concise as possible, to the level specified in the ICAO language proficiency requirements contained in ICAO Annex 1 — *Personnel Licensing*, in order to avoid possible confusion by those persons using a language other than one of their national languages.

12.2.2 The phraseologies are grouped according to types of air traffic service for convenience of reference. However, users shall be familiar with, and use as necessary, phraseologies from groups other than those referring specifically to the type of air traffic service being provided. All phraseologies shall be used in conjunction with call signs (aircraft, ground vehicle, ATC or other) as appropriate. In order that the phraseologies listed should be readily discernible in Section 12.3, call signs have been omitted. Provisions for the compilation of RTF messages, call signs and procedures are contained in ICAO Annex 10, Volume II, Chapter 5.

12.2.3 Section 12.3 includes phrases for use by pilots, ATS personnel and other ground personnel.

12.2.4 During operations in or vertical transit through reduced vertical separation minimum (RVSM) airspace with aircraft not approved for RVSM operations, pilots shall report non-approved status in accordance with 12.3.1.12 c) as follows:

- a) at initial call on any channel within RVSM airspace;
- b) in all requests for level changes; and

c) in all read-backs of level clearances.

12.2.5 Air traffic controllers shall explicitly acknowledge receipt of messages from aircraft reporting RVSM non-approved status.

12.2.6 Phraseologies for the movement of vehicles, other than tow-tractors, on the manoeuvring area shall be the same as those used for the movement of aircraft, with the exception of taxi instructions, in which case the word “PROCEED” shall be substituted for the word “TAXI” when communicating with vehicles.

12.2.7 Conditional phrases, such as “behind landing aircraft” or “after departing aircraft”, shall not be used for movements affecting the active runway(s), except when the aircraft or vehicles concerned are seen by the appropriate controller and pilot. The aircraft or vehicle causing the condition in the clearance issued shall be the first aircraft/vehicle to pass in front of the other aircraft concerned. In all cases a conditional clearance shall be given in the following order and consist of:

- a) identification;
- b) the condition;
- c) the clearance; and
- d) brief reiteration of the condition, for example:

“SAS 941, BEHIND DC9 ON SHORT FINAL, LINE UP BEHIND”.

Note — This implies the need for the aircraft receiving the conditional clearance to identify the aircraft or vehicle causing the conditional clearance.

12.2.8 The phraseology in Section 12.3 does not include phrases and regular radiotelephony procedure words contained in ICAO Annex 10, Volume II.

12.2.9 Words in parentheses indicate that specific information, such as a level, a place or a time, etc., must be inserted to complete the phrase, or alternatively that optional phrases may be used. Words in square parentheses indicate optional additional words or information that may be necessary in specific instances.

12.2.10 Examples of the application of the phraseologies may be found in the *Manual of Radiotelephony* (Doc 9432).

12.2.11 Aeronautical stations are identified by the name of the location followed by a suffix. The suffix indicates the type of unit or service provided.

Unit or Service	Call sign suffix
Area Control Centre	CONTROL
Radar (in general)	RADAR
Approach control	APPROACH
Approach control radar arrivals	ARRIVAL
Approach control radar departures	DEPARTURE
Aerodrome control	TOWER
Surface movement control	GROUND
Clearance delivery	DELIVERY
Flight information service	INFORMATION
Aeronautical station	RADIO

12.3 ATC PHRASEOLOGIES

12.3.1 General

Circumstances

Phraseologies

12.3.1.1 DESCRIPTION OF LEVELS (SUBSEQUENTLY REFERRED TO AS “(LEVEL)”)	a) FLIGHT LEVEL (<i>number</i>); <i>or</i> b) (<i>number</i>) METRES; <i>or</i> c) (<i>number</i>) FEET.
12.3.1.2 LEVEL CHANGES, REPORTS AND RATES	a) CLIMB (<i>or</i> DESCEND); <i>followed as necessary by:</i> 1) TO (<i>level</i>); 2) TO AND MAINTAIN BLOCK (<i>level</i>) TO (<i>level</i>); 3) TO REACH (<i>level</i>) AT (<i>or</i> BY) (<i>time or significant point</i>); 4) REPORT LEAVING (<i>or</i> REACHING, <i>or</i> PASSING) (<i>level</i>); 5) AT (<i>number</i>) METRES PER SECOND (<i>or</i> FEET PER MINUTE) [OR GREATER (<i>or</i> OR LESS)]; b) MAINTAIN AT LEAST (<i>number</i>) METRES (<i>or</i> FEET) ABOVE (<i>or</i> BELOW) (<i>aircraft call sign</i>); c) REQUEST LEVEL (<i>or</i> FLIGHT LEVEL <i>or</i>
... instruction that a climb (or descent) to a level within the vertical range defined is to commence	

	ALTITUDE) CHANGE FROM (<i>name of unit</i>) [AT (<i>time or significant point</i>)];
	d) STOP CLIMB (<i>or DESCENT</i>) AT (<i>level</i>);
	e) CONTINUE CLIMB (<i>or DESCENT</i>) TO (<i>level</i>);
	f) EXPEDITE CLIMB (<i>or DESCENT</i>) [UNTIL PASSING (<i>level</i>)];
	g) WHEN READY CLIMB (<i>or DESCEND</i>) TO (<i>level</i>);
	h) EXPECT CLIMB (<i>or DESCENT</i>) AT (<i>time or significant point</i>);
	*i) REQUEST DESCENT AT (<i>time</i>)
<i>Circumstances</i>	<i>Phraseologies</i>
... to require action at a specific time or place	j) IMMEDIATELY; k) AFTER PASSING (<i>significant point</i>); l) AT (<i>time or significant point</i>);
... to require action when convenient	m) WHEN READY (<i>instruction</i>);
... to require an aircraft to climb or descend maintaining own separation and VMC	n) MAINTAIN OWN SEPARATION AND VMC [FROM (<i>level</i>)] [TO (<i>level</i>)]; o) MAINTAIN OWN SEPARATION AND VMC ABOVE (<i>or BELOW, or TO</i>) (<i>level</i>);
... when there is doubt that an aircraft can comply with a clearance or instruction	p) IF UNABLE (<i>alternative instructions</i>) AND ADVISE;
... when a pilot is unable to comply with a clearance or instruction	*q) UNABLE;
... after a flight crew starts to deviate from any ATC clearance or instruction to comply with an ACAS resolution advisory (RA) (Pilot and controller interchange)	*r) TCAS RA; s) ROGER;
... after the response to an ACAS RA is completed and a return to the ATC clearance or instruction is initiated (Pilot and controller interchange)	*t) CLEAR OF CONFLICT, RETURNING TO (<i>assigned clearance</i>); u) ROGER (<i>or alternative instructions</i>);
... after the response to an ACAS	*v) CLEAR OF CONFLICT (<i>assigned clearance</i>)

RA is completed and the assigned ATC clearance or instruction has been resumed (Pilot and controller interchange)

RESUMED;

w) ROGER (*or alternative instructions*);

... after an ATC clearance or instruction contradictory to the ACAS RA is received, the flight crew will follow the RA and inform ATC directly (Pilot and controller interchange)

*x) UNABLE, TCAS RA;

y) ROGER;

Circumstances

Phraseologies

... clearance to cancel level restriction(s) of the vertical profile of a SID during climb

*z) CLIMB TO (*level*) [LEVEL RESTRICTION(S) (*SID designator*) CANCELLED (*or*) LEVEL RESTRICTION(S) (*SID designator*) AT (*point*) CANCELLED];

... clearance to cancel level restriction(s) of the vertical profile of a STAR during descent

aa) DESCEND TO (*level*) [LEVEL RESTRICTION(S) (*STAR designator*) CANCELLED (*or*) LEVEL RESTRICTION(S) (*STAR designator*) AT (*point*) CANCELLED].

* Denotes pilot transmission.

12.3.1.3 MINIMUM FUEL

*a) MINIMUM FUEL

... indication of minimum fuel

b) ROGER [NO DELAY EXPECTED *or* EXPECT (*delay information*)].

*Denotes pilot transmission.

Circumstances

Phraseologies

12.3.1.4 TRANSFER OF CONTROL AND/OR FREQUENCY CHANGE

a) CONTACT (*unit call sign*) (*frequency*) [NOW];

b) AT (*or OVER*) (*time or place*) [*or WHEN*] [PASSING/LEAVING/REACHING] (*level*)

CONTACT

(*unit call sign*) (*frequency*);

c) IF NO CONTACT (*instructions*);

Note.— An aircraft may be requested to

d) STAND BY FOR (*unit call sign*) (*frequency*);

“STAND BY” on a frequency when it is intended that the ATS unit will initiate communications soon and to “MONITOR” a frequency when information is being broadcast thereon.

- *e) REQUEST CHANGE TO (*frequency*);
 - f) FREQUENCY CHANGE APPROVED;
 - g) MONITOR (*unit call sign*) (*frequency*);
 - *h) MONITORING (*frequency*);
 - i) WHEN READY CONTACT (*unit call sign*) (*frequency*);
 - j) REMAIN THIS FREQUENCY.
- * Denotes pilot transmission.

12.3.1.5 8.33 KHZ CHANNEL SPACING

Note.— In this paragraph, the term “point” is used only in the context of naming the 8.33 kHz channel spacing concept and does not constitute any change to existing ICAO provisions or phraseology regarding the use of the term “decimal”.

- | | |
|--|---------------------------------------|
| ... to request confirmation of 8.33 kHz capability | a) CONFIRM EIGHT POINT THREE THREE; |
| ... to indicate 8.33 kHz capability | *b) AFFIRM EIGHT POINT THREE THREE; |
| ... to indicate lack of 8.33 kHz capability | *c) NEGATIVE EIGHT POINT THREE THREE; |
| ... to request UHF capability | d) CONFIRM UHF; |
| ... to indicate UHF capability | *e) AFFIRM UHF; |
| ... to indicate lack of UHF capability | *f) NEGATIVE UHF; |

Circumstances

Phraseologies

- | | |
|--|--|
| ... to request status in respect of 8.33 kHz exemption | g) CONFIRM EIGHT POINT THREE THREE EXEMPTED; |
| ... to indicate 8.33 kHz exempted status | *h) AFFIRM EIGHT POINT THREE THREE EXEMPTED; |
| ... to indicate 8.33 kHz non-exempted status | *i) NEGATIVE EIGHT POINT THREE THREE EXEMPTED; |
| ... to indicate that a certain clearance is given because otherwise a non-equipped and/or non-exempted aircraft would enter airspace of mandatory carriage | j) DUE EIGHT POINT THREE THREE REQUIREMENT. |
- * Denotes pilot transmission

12.3.1.6 CHANGE OF CALL SIGN

... to instruct an aircraft to change its type of call sign	a) CHANGE YOUR CALL SIGN TO (<i>new call sign</i>) [UNTIL FURTHER ADVISED];
... to advise an aircraft to revert to the call sign indicated in the flight plan	b) REVERT TO FLIGHT PLAN CALL SIGN (<i>call sign</i>) [AT (<i>significant point</i>)].
12.3.1.7 TRAFFIC INFORMATION	a) TRAFFIC (<i>information</i>);
... to pass traffic information	b) NO REPORTED TRAFFIC;
... to acknowledge traffic information	*c) LOOKING OUT; *d) TRAFFIC IN SIGHT; *e) NEGATIVE CONTACT [<i>reasons</i>]; f) [ADDITIONAL] TRAFFIC (<i>direction</i>) BOUND (<i>type of aircraft</i>) (<i>level</i>) ESTIMATED (<i>or</i> OVER) (<i>significant point</i>) AT (<i>time</i>); g) TRAFFIC IS (<i>classification</i>) UNMANNED FREE BALLOON(S) WAS [<i>or</i> ESTIMATED] OVER (<i>place</i>) AT (<i>time</i>) REPORTED (<i>level(s)</i>) [<i>or</i> LEVEL UNKNOWN] MOVING (<i>direction</i>) (<i>other pertinent information, if any</i>).
	* Denotes pilot transmission.

*Circumstances**Phraseologies*

12.3.1.8 METEOROLOGICAL CONDITIONS	a) [SURFACE] WIND (<i>number</i>) DEGREES (<i>speed</i>) (<i>units</i>); b) WIND AT (<i>level</i>) (<i>number</i>) DEGREES (<i>number</i>) KILOMETRES PER HOUR (<i>or</i> KNOTS); <i>Note.— Wind is always expressed by giving the mean direction and speed and any significant variations thereof.</i> c) VISIBILITY (<i>distance</i>) (<i>units</i>) [<i>direction</i>]; d) RUNWAY VISUAL RANGE (<i>or</i> RVR) [RUNWAY (<i>number</i>)] (<i>distance</i>) (<i>units</i>); e) RUNWAY VISUAL RANGE (<i>or</i> RVR) RUNWAY (<i>number</i>) NOT AVAILABLE (<i>or</i> NOT REPORTED);
------------------------------------	---

... for multiple RVR observations

f) RUNWAY VISUAL RANGE (*or* RVR)
[RUNWAY (*number*)] (*first position*) (*distance*) (*units*), (*second position*) (*distance*) (*units*), (*third position*) (*distance*) (*units*)

Note 1.— Multiple RVR observations are always representative of the touchdown zone, midpoint zone and the roll-out/stop end zone, respectively.

Note 2.— Where reports for three locations are given, the indication of these locations may be omitted, provided that the reports are passed in the order of touchdown zone, followed by the midpoint zone and ending with the roll-out/stop end zone report.

... in the event that RVR information on any one position is not available this information will be included in the appropriate sequence

g) RUNWAY VISUAL RANGE (*or* RVR)
[RUNWAY (*number*)] (*first position*) (*distance*) (*units*), (*second position*) NOT AVAILABLE, (*third position*) (*distance*) (*units*);

Circumstances

Phraseologies

h) PRESENT WEATHER (*details*);

i) CLOUD (*amount*, [(*type*)] and *height of base*) (*units*) (*or* SKY CLEAR);

Note.— Details of the means to describe the amount and type of cloud are in Chapter 11, 11.4.3.2.3.5.

j) CAVOK;

Note.— CAVOK pronounced CAV-O-KAY.

k) TEMPERATURE [MINUS] (*number*) (*and/or* DEW-POINT [MINUS] (*number*));

l) QNH (*number*) [*units*];

m) QFE (*number*) [(*units*)];

n) (*aircraft type*) REPORTED (*description*) ICING (*or* TURBULENCE) [IN CLOUD] (*area*) (*time*);

o) REPORT FLIGHT CONDITIONS.

12.3.1.9 POSITION REPORTING

a) NEXT REPORT AT (*significant point*);

... to omit position reports until a specified position

b) OMIT POSITION REPORTS [UNTIL

	(<i>specify</i>)];
	c) RESUME POSITION REPORTING.
12.3.1. 10 ADDITIONAL REPORTS	a) REPORT PASSING (<i>significant point</i>);
... to request a report at a specified place or distance	b) REPORT (<i>distance</i>) MILES (GNSS or DME) FROM (<i>name of DME station</i>) (<i>or significant point</i>);
... to report at a specified place or distance	*c) (<i>distance</i>) MILES (GNSS or DME) FROM (<i>name of DME station</i>) (<i>or significant point</i>);
	d) REPORT PASSING (<i>three digits</i>) RADIAL (<i>name of VOR</i>) VOR;
... to request a report of present position	e) REPORT (GNSS or DME) DISTANCE FROM (<i>significant point</i>) <i>or</i> (<i>name of DME station</i>);
... to report present position	*f) (<i>distance</i>) MILES (GNSS or DME) FROM (<i>name of DME station</i>) (<i>or significant point</i>).
	* Denotes pilot transmission.

*Circumstances**Phraseologies*

12.3.1.11 AERODROME INFORMATION	a) [(<i>location</i>)] RUNWAY SURFACE CONDITION RUNWAY (<i>number</i>) (<i>condition</i>);
	b) [(<i>location</i>)] RUNWAY SURFACE CONDITION RUNWAY (<i>number</i>) NOT CURRENT;
	c) LANDING SURFACE (<i>condition</i>);
	d) CAUTION CONSTRUCTION WORK (<i>location</i>);
	e) CAUTION (<i>specify reasons</i>) RIGHT (<i>or</i> LEFT), (<i>or</i> BOTH SIDES) OF RUNWAY [<i>number</i>];
	f) CAUTION WORK IN PROGRESS (<i>or</i> OBSTRUCTION) (<i>position and any necessary advice</i>);
	g) RUNWAY REPORT AT (<i>observation time</i>) RUNWAY (<i>number</i>) (<i>type of precipitant</i>) UP TO (<i>depth of deposit</i>) MILLIMETRES. BRAKING ACTION GOOD (<i>or</i> MEDIUM TO GOOD, <i>or</i> MEDIUM, <i>or</i> MEDIUM TO POOR, <i>or</i> POOR <i>or</i> UNRELIABLE) [<i>and/or</i> BRAKING

- COEFFICIENT (*equipment and number*);
- h) BRAKING ACTION REPORTED BY (*aircraft type*) AT (*time*) GOOD (*or*) MEDIUM, *or* POOR);
- i) BRAKING ACTION [(*location*)] (*measuring equipment used*),
RUNWAY (*number*), TEMPERATURE [MINUS] (*number*), WAS (*reading*) AT (*time*);
- j) RUNWAY (*or*) TAXIWAY (*number*) WET [*or*] DAMP, WATER PATCHES, FLOODED (*depth*),
- k) TOWER OBSERVES (*weather information*);
- l) PILOT REPORTS (*weather information*).

*Circumstances**Phraseologies*

12.3.1.12 OPERATIONAL STATUS OF VISUAL AND NON-VISUAL AIDS

- a) (*specify visual or non-visual aid*) RUNWAY (*number*) (*description of deficiency*);
- b) (*type*) LIGHTING (*unservicability*);
- c) GBAS/SBAS/MLS/ILS CATEGORY (*category*) (*servicability state*);
- d) TAXIWAY LIGHTING (*description of deficiency*);
- e) (*type of visual approach slope indicator*)
RUNWAY (*number*) (*description of deficiency*).

12.3.1.13 REDUCED VERTICAL SEPARATION MINIMUM (RVSM) OPERATIONS

... to ascertain RVSM approval status of an aircraft

- a) CONFIRM RVSM APPROVED;

... to report RVSM approved status

- *b) AFFIRM RVSM;

... to report RVSM non-approved status followed by supplementary information

- *c) NEGATIVE RVSM [(*supplementary information, e.g. State Aircraft*)];

Note.— See 12.2.4 and 12.2.5 for procedures relating to operations in RVSM airspace by aircraft with non-approved status.

... to deny ATC clearance into RVSM airspace

- d) UNABLE ISSUE CLEARANCE INTO RVSM AIRSPACE, MAINTAIN [*or*] DESCEND TO, *or*

	CLIMB TO] (<i>level</i>);
... to report when severe turbulence affects the capability of an aircraft to maintain height-keeping requirements for RVSM	*e) UNABLE RVSM DUE TURBULENCE;
... to report that the equipment of an aircraft has degraded below minimum aviation system performance standards	*f) UNABLE RVSM DUE EQUIPMENT;
...to request an aircraft to provide information as soon as RVSM-approved status has been regained or the pilot is ready to resume RVSM operations	g) REPORT WHEN ABLE TO RESUME RVSM;
<i>Circumstances</i>	<i>Phraseologies</i>
... to request confirmation that an aircraft has regained RVSM-approved status or a pilot is ready to resume RVSM operations	h) CONFIRM ABLE TO RESUME RVSM;
... to report ability to resume RVSM operations after an equipment or weather-related contingency	*i) READY TO RESUME RVSM. * Denotes pilot transmission
12.3.1.14 GNSS SERVICE STATUS	a) GNSS REPORTED UNRELIABLE (<i>or</i> GNSS MAY NOT BE AVAILABLE [DUE TO INTERFERENCE]); 1) IN THE VICINITY OF (<i>location</i>) (<i>radius</i>) [BETWEEN (<i>levels</i>)]; <i>or</i> 2) IN THE AREA OF (<i>description</i>) (<i>or</i> IN (<i>name</i>) FIR) [BETWEEN (<i>levels</i>)]; b) BASIC GNSS (<i>or</i> SBAS, <i>or</i> GBAS) UNAVAILABLE FOR (<i>specify operation</i>) [FROM (<i>time</i>) TO (<i>time</i>) (<i>or</i> UNTIL FURTHER NOTICE)]; *c) BASIC GNSS UNAVAILABLE [DUE TO (<i>reason e.g. LOSS OF RAIM or RAIM ALERT</i>)]; *d) GBAS (<i>or</i> SBAS) UNAVAILABLE. * Denotes pilot transmission.
12.3.1.15 DEGRADATION OF AIRCRAFT NAVIGATION PERFORMANCE	UNABLE RNP (<i>specify type</i>) (<i>or</i> RNAV) [DUE TO (<i>reason e.g. LOSS OF RAIM or RAIM ALERT</i>)].

12.3.2 Area control services

<i>Circumstances</i>	<i>Phraseologies</i>
12.3.2.1 ISSUANCE OF A CLEARANCE	a) <i>(name of unit)</i> CLEARS <i>(aircraft call sign)</i> ; b) <i>(aircraft call sign)</i> CLEARED TO; c) RECLEARED <i>(amended clearance details)</i> [REST OF CLEARANCE UNCHANGED]; d) RECLEARED <i>(amended route portion)</i> TO <i>(significant point of original route)</i> [REST OF CLEARANCE UNCHANGED]; e) ENTER CONTROLLED AIRSPACE <i>(or</i> CONTROL ZONE) [VIA <i>(significant point or</i> <i>route)</i>] AT <i>(level)</i> [AT <i>(time)</i>]; f) LEAVE CONTROLLED AIRSPACE <i>(or</i> CONTROL ZONE) [VIA <i>(significant point or</i> <i>route)</i>] AT <i>(level)</i> <i>(or</i> CLIMBING, <i>or</i> DESCENDING); g) JOIN <i>(specify)</i> AT <i>(significant point)</i> AT <i>(level)</i> [AT <i>(time)</i>].
12.3.2.2 INDICATION OF ROUTE AND CLEARANCE LIMIT	a) FROM <i>(location)</i> TO <i>(location)</i> ; b) TO <i>(location)</i> , <i>followed as necessary by</i> : 1) DIRECT; 2) VIA <i>(route and/or significant points)</i> ; 3) VIA FLIGHT PLANNED ROUTE; <i>Note.— Conditions associated with the use of this</i> <i>phrase are in Chapter 4, 4.5.7.2.</i> 4) VIA <i>(distance)</i> DME ARC <i>(direction)</i> OF <i>(name of DME station)</i> ; c) <i>(route)</i> NOT AVAILABLE DUE <i>(reason)</i> ALTERNATIVE[S] IS/ARE <i>(routes)</i> ADVISE.
12.3.2.3 MAINTENANCE OF SPECIFIED LEVELS	a) MAINTAIN <i>(level)</i> [TO <i>(significant point)</i>];

- b) MAINTAIN (*level*) UNTIL PASSING (*significant point*);
- c) MAINTAIN (*level*) UNTIL (*minutes*) AFTER PASSING (*significant point*);
- d) MAINTAIN (*level*) UNTIL (*time*);
- e) MAINTAIN (*level*) UNTIL ADVISED BY (*name of unit*);
- f) MAINTAIN (*level*) UNTIL FURTHER ADVISED;
- g) MAINTAIN (*level*) WHILE IN CONTROLLED AIRSPACE;
- h) MAINTAIN BLOCK (*level*) TO (*level*).

Note.— The term “MAINTAIN” is not to be used in lieu of “DESCEND” or “CLIMB” when instructing an aircraft to change level.

12.3.2.4 SPECIFICATION OF CRUISING LEVELS

- a) CROSS (*significant point*) AT (*or ABOVE, or BELOW*) (*level*);
- b) CROSS (*significant point*) AT (*time*) OR LATER (*or BEFORE*) AT (*level*);
- c) CROSS (*distance*) MILES, (GNSS *or* DME) [(*direction*)] OF (*name of DME station*) OR (*distance*) [(*direction*)] OF (*significant point*) AT (*or ABOVE or BELOW*) (*level*).

Circumstances

Phraseologies

12.3.2.5 EMERGENCY DESCENT

- *a) EMERGENCY DESCENT (*intentions*);
- b) ATTENTION ALL AIRCRAFT IN THE VICINITY OF [*or AT*] (*significant point or location*) EMERGENCY DESCENT IN PROGRESS FROM (*level*) (followed as necessary by specific instructions, clearances, traffic information, etc.).

* Denotes pilot transmission.

12.3.2.6 IF CLEARANCE CANNOT BE ISSUED IMMEDIATELY UPON REQUEST

- EXPECT CLEARANCE (*or type of clearance*) AT (*time*).

12.3.2.7	WHEN CLEARANCE FOR DEVIATION CANNOT BE ISSUED	UNABLE, TRAFFIC (<i>direction</i>) BOUND (<i>type of aircraft</i>) (<i>level</i>) ESTIMATED (<i>or</i> OVER) (<i>significant point</i>) AT (<i>time</i>) CALL SIGN (<i>call sign</i>) ADVISE INTENTIONS.
12.3.2.8	SEPARATION INSTRUCTIONS	<p>a) CROSS (<i>significant point</i>) AT (<i>time</i>) [OR LATER (<i>or</i> OR BEFORE)];</p> <p>b) ADVISE IF ABLE TO CROSS (<i>significant point</i>) AT (<i>time or level</i>);</p> <p>c) MAINTAIN MACH (<i>number</i>) [OR GREATER (<i>or</i> OR LESS)] [UNTIL (<i>significant point</i>)];</p> <p>d) DO NOT EXCEED MACH (<i>number</i>).</p>
12.3.2.9	INSTRUCTIONS ASSOCIATED WITH FLYING A TRACK (OFFSET), PARALLEL TO THE CLEARED ROUTE	<p>a) ADVISE IF ABLE TO PROCEED PARALLEL OFFSET;</p> <p>b) PROCEED OFFSET (<i>distance</i>) RIGHT/LEFT OF (<i>route</i>) (<i>track</i>) [CENTRE LINE] [AT (<i>significant point or time</i>)] [UNTIL (<i>significant point or time</i>)];</p> <p>c) CANCEL OFFSET (<i>instructions to rejoin cleared flight route or other information</i>).</p>

12.3.3 Approach control services

Circumstances

Phraseologies

12.3.3.1	DEPARTURE INSTRUCTIONS	<p>a) [AFTER DEPARTURE] TURN RIGHT (<i>or</i> LEFT) HEADING (<i>three digits</i>) (<i>or</i> CONTINUE RUNWAY HEADING) (<i>or</i> TRACK EXTENDED CENTRE LINE) TO (<i>level or significant point</i>) [(<i>other instructions as required</i>)];</p> <p>b) AFTER REACHING (<i>or</i> PASSING) (<i>level or significant point</i>) (<i>instructions</i>);</p> <p>c) TURN RIGHT (<i>or</i> LEFT) HEADING (<i>three digits</i>) TO (<i>level</i>) [TO INTERCEPT (<i>track, route,</i></p>
----------	------------------------	--

airway, etc.);

d) *(standard departure name and number)*

DEPARTURE;

e) TRACK *(three digits)* DEGREES

[MAGNETIC *(or TRUE)*] TO *(or FROM)*

(significant point) UNTIL *(time, or REACHING*

(fix or significant point or level)) [BEFORE

PROCEEDING ON COURSE];

f) CLEARED VIA *(designation)*.

Note.— Conditions associated with the use of this phrase are in Chapter 4, 4.5.7.2.

12.3.3.2 APPROACH INSTRUCTIONS

a) CLEARED *(or PROCEED)* VIA *(designation)*;

b) CLEARED TO *(clearance limit)* VIA *(designation)*;

Circumstances

Phraseologies

c) CLEARED *(or PROCEED)* VIA *(details of route to be followed)*;

d) CLEARED *(type of approach)* APPROACH [RUNWAY *(number)*];

e) CLEARED *(type of approach)* RUNWAY *(number)* FOLLOWED BY CIRCLING TO RUNWAY *(number)*;

f) CLEARED APPROACH [RUNWAY *(number)*];

g) COMMENCE APPROACH AT *(time)*;

h) REQUEST STRAIGHT-IN [(type of approach)*] APPROACH [RUNWAY *(number)*];

i) CLEARED STRAIGHT-IN [*(type of approach)*] APPROACH [RUNWAY *(number)*];

j) REPORT VISUAL;

k) REPORT RUNWAY [LIGHTS] IN SIGHT;

*l) REQUEST VISUAL APPROACH;

... when a pilot requests a visual approach

... to request if a pilot is able to accept a visual approach

Note.—See 6.5.3 for provisions relating to visual approach procedures.

... in case of successive visual approaches when the pilot of a succeeding aircraft has reported having the preceding aircraft in sight

m) CLEARED VISUAL APPROACH RUNWAY
(*number*);

n) ADVISE ABLE TO ACCEPT VISUAL APPROACH RUNWAY (*number*);

o) CLEARED VISUAL APPROACH RUNWAY (*number*), MAINTAIN OWN SEPARATION FROM PRECEDING (*aircraft type and wake turbulence category as appropriate*) [CAUTION WAKE TURBULENCE];

(Callsign) CAUTION WAKE TURBULENCE, THE RECOMMENDED DISTANCE IS (*number*) MILES.

Circumstances

Phraseologies

p) REPORT (*significant point*); [OUTBOUND, or INBOUND];

q) REPORT COMMENCING PROCEDURE TURN;

*r) REQUEST VMC DESCENT;

s) MAINTAIN OWN SEPARATION;

t) MAINTAIN VMC;

u) ARE YOU FAMILIAR WITH (*name*) APPROACH PROCEDURE;

*v) REQUEST (*type of approach*) APPROACH [RUNWAY (*number*)];

*w) REQUEST (MLS/RNAV plain-language designator);

x) CLEARED (*MLS/RNAV plain-language designator*).

* Denotes pilot transmission.

<i>Circumstances</i>	<i>Phraseologies</i>
12.3.3.3 HOLDING CLEARANCES	
... visual	a) HOLD VISUAL [OVER] (<i>position</i>), (<i>or</i>) BETWEEN (<i>two prominent landmarks</i>);
... published holding procedure over a facility or fix	b) CLEARED (<i>or</i> PROCEED) TO (<i>significant point, name of facility or fix</i>) [MAINTAIN (<i>or</i> CLIMB <i>or</i> DESCEND TO) (<i>level</i>)] HOLD [(<i>direction</i>)] AS PUBLISHED EXPECT APPROACH CLEARANCE (<i>or</i> FURTHER CLEARANCE) AT (<i>time</i>);
... when a detailed holding clearance is required	*c) REQUEST HOLDING INSTRUCTIONS; d) CLEARED (<i>or</i> PROCEED) TO (<i>significant point, name of facility or fix</i>) [MAINTAIN (<i>or</i> CLIMB <i>or</i> DESCEND TO) (<i>level</i>)] HOLD [(<i>direction</i>)] [(<i>specified</i>) RADIAL, COURSE, INBOUND TRACK (<i>three digits</i>) DEGREES] [RIGHT (<i>or</i> LEFT) HAND PATTERN] [OUTBOUND TIME (<i>number</i>) MINUTES] EXPECT APPROACH CLEARANCE (<i>or</i> FURTHER CLEARANCE) AT (<i>time</i>) (<i>additional instructions, if necessary</i>); e) CLEARED TO THE (<i>three digits</i>) RADIAL OF THE (<i>name</i>) VOR AT (<i>distance</i>) DME FIX [MAINTAIN (<i>or</i> CLIMB <i>or</i> DESCEND TO) (<i>level</i>)] HOLD [(<i>direction</i>)] [RIGHT (<i>or</i> LEFT) HAND PATTERN] [OUTBOUND TIME (<i>number</i>) MINUTES] EXPECT APPROACH CLEARANCE (<i>or</i> FURTHER CLEARANCE) AT (<i>time</i>) (<i>additional instructions, if necessary</i>);

*Circumstances**Phraseologies*

f) CLEARED TO THE (*three digits*) RADIAL OF THE (*name*) VOR AT (*distance*) DME FIX [MAINTAIN (*or CLIMB or DESCEND TO*) (*level*)] HOLD BETWEEN (*distance*) AND (*distance*) DME [RIGHT (*or LEFT*) HAND PATTERN] EXPECT APPROACH CLEARANCE (*or FURTHER CLEARANCE*) AT (*time*) (*additional instructions, if necessary*).

* Denotes pilot transmission.

12.3.3.4 EXPECTED APPROACH TIME

- a) NO DELAY EXPECTED;
- b) EXPECTED APPROACH TIME (*time*);
- c) REVISED EXPECTED APPROACH TIME (*time*);
- d) DELAY NOT DETERMINED (*reasons*).

12.3.4 Phraseologies for use on and in the vicinity of the aerodrome

<i>Circumstances</i>	<i>Phraseologies</i>
12.3.4.1 IDENTIFICATION OF AIRCRAFT	SHOW LANDING LIGHTS.
12.3.4.2 ACKNOWLEDGEMENT BY VISUAL MEANS	a) ACKNOWLEDGE BY MOVING AILERONS (or RUDDER); b) ACKNOWLEDGE BY ROCKING WINGS; c) ACKNOWLEDGE BY FLASHING LANDING LIGHTS.
12.3.4.3 STARTING PROCEDURES	
... to request permission to start engines	*a) [<i>aircraft location</i>] REQUEST START UP; *b) [<i>aircraft location</i>] REQUEST START UP, INFORMATION (<i>ATIS identification</i>);
... ATC replies	c) START UP APPROVED; d) START UP AT (<i>time</i>); e) EXPECT START UP AT (<i>time</i>); f) START UP AT OWN DISCRETION; g) EXPECT DEPARTURE (<i>time</i>) START UP AT OWN DISCRETION.
	* Denotes pilot transmission.
12.3.4.4 PUSH-BACK PROCEDURES	
<i>Note.— When local procedures so prescribe, authorization for pushback should be obtained from the control tower.</i>	
... aircraft/ATC	*a) [<i>aircraft location</i>] REQUEST PUSHBACK; b) PUSHBACK APPROVED; c) STAND BY; d) PUSHBACK AT OWN DISCRETION; e) EXPECT (<i>number</i>) MINUTES DELAY DUE (<i>reason</i>).
	* Denotes pilot transmission.

<i>Circumstances</i>	<i>Phraseologies</i>
12.3.4.5 TOWING PROCEDURES	†a) REQUEST TOW [<i>company name</i>] (<i>aircraft type</i>) FROM (<i>location</i>) TO (<i>location</i>);
... ATC response	b) TOW APPROVED VIA (<i>specific routing to be followed</i>); c) HOLD POSITION; d) STAND BY.
	† Denotes transmission from aircraft/tow vehicle combination.
12.3.4.6 TO REQUEST TIME CHECK AND/OR AERODROME DATA FOR DEPARTURE	*a) REQUEST TIME CHECK; b) TIME (<i>time</i>);
... when no ATIS broadcast is available	*c) REQUEST DEPARTURE INFORMATION; d) RUNWAY (<i>number</i>), WIND (<i>direction and speed</i>) (<i>units</i>) QNH (or QFE) (<i>number</i>) [(<i>units</i>)] TEMPERATURE [MINUS] (<i>number</i>), [VISIBILITY (<i>distance</i>) (<i>units</i>) (or RUNWAY VISUAL RANGE (or RVR) (<i>distance</i>) (<i>units</i>))] [TIME (<i>time</i>)]. <i>Note.— If multiple visibility and RVR observations are available, those that represent the roll-out/stop end zone should be used for take-off.</i>
	* Denotes pilot transmission.
12.3.4.7 TAXI PROCEDURES	
... for departure	*a) [<i>aircraft type</i>] [<i>wake turbulence category if “heavy”</i>] [<i>aircraft location</i>] REQUEST TAXI [<i>intentions</i>]; *b) [<i>aircraft type</i>] [<i>wake turbulence category if “heavy”</i>] [<i>aircraft location</i>] (<i>flight rules</i>) TO (<i>aerodrome of destination</i>) REQUEST TAXI [<i>intentions</i>]; c) TAXI TO HOLDING POINT [<i>number</i>] [RUNWAY (<i>number</i>)] [HOLD SHORT OF RUNWAY (<i>number</i>) (or CROSS RUNWAY (<i>number</i>))] [TIME (<i>time</i>)];

<i>Circumstances</i>	<i>Phraseologies</i>
... where detailed taxi instructions are required	<p>*d) [<i>aircraft type</i>] [<i>wake turbulence category if “heavy”</i>] REQUEST DETAILED TAXI INSTRUCTIONS;</p> <p>e) TAXI TO HOLDING POINT [<i>number</i>] [<i>RUNWAY (number)</i>] VIA (<i>specific route to be followed</i>) [<i>TIME (time)</i>] [<i>HOLD SHORT OF RUNWAY (number) (or CROSS RUNWAY (number))</i>];</p>
... where aerodrome information is not available from an alternative source such as ATIS	<p>f) TAXI TO HOLDING POINT [<i>number</i>] (<i>followed by aerodrome information as applicable</i>) [<i>TIME (time)</i>];</p> <p>g) TAKE (<i>or TURN</i>) FIRST (<i>or SECOND</i>) LEFT (<i>or RIGHT</i>);</p> <p>h) TAXI VIA (<i>identification of taxiway</i>);</p> <p>i) TAXI VIA RUNWAY (<i>number</i>);</p> <p>j) TAXI TO TERMINAL (<i>or other location, e.g. GENERAL AVIATION AREA</i>) [<i>STAND (number)</i>];</p>
... for helicopter operations	<p>*k) REQUEST AIR-TAXIING FROM (<i>or VIA</i>) TO (<i>location or routing as appropriate</i>);</p> <p>l) AIR-TAXI TO (<i>or VIA</i>) (<i>location or routing as appropriate</i>) [<i>CAUTION (dust, blowing snow, loose debris, taxiing light aircraft, personnel, etc.)</i>];</p> <p>m) AIR TAXI VIA (<i>direct, as requested, or specified route</i>) TO (<i>location, heliport, operating or movement area, active or inactive runway</i>). AVOID (<i>aircraft or vehicles or personnel</i>);</p>
... after landing	<p>*n) REQUEST BACKTRACK;</p> <p>o) BACKTRACK APPROVED;</p> <p>p) BACKTRACK RUNWAY (<i>number</i>);</p>

<i>Circumstances</i>	<i>Phraseologies</i>
... general	<p>*q) [(<i>aircraft location</i>)] REQUEST TAXI TO (<i>destination on aerodrome</i>);</p> <p>r) TAXI STRAIGHT AHEAD;</p> <p>s) TAXI WITH CAUTION;</p> <p>t) GIVE WAY TO (<i>description and position of other aircraft</i>);</p> <p>*u) GIVING WAY TO (<i>traffic</i>);</p> <p>*v) TRAFFIC (<i>or type of aircraft</i>) IN SIGHT;</p> <p>w) TAXI INTO HOLDING BAY;</p> <p>x) FOLLOW (<i>description of other aircraft or vehicle</i>);</p> <p>y) VACATE RUNWAY;</p> <p>*z) RUNWAY VACATED;</p> <p>aa) EXPEDITE TAXI [(<i>reason</i>)];</p> <p>*bb) EXPEDITING;</p> <p>cc) [CAUTION] TAXI SLOWER [<i>reason</i>];</p> <p>*dd) SLOWING DOWN.</p>
12.3.4.8 HOLDING	<p>* Denotes pilot transmission.</p> <p>‡a) HOLD (<i>direction</i>) OF (<i>position, runway number, etc.</i>);</p> <p>‡b) HOLD POSITION;</p> <p>‡c) HOLD (<i>distance</i>) FROM (<i>position</i>);</p> <p>‡d) HOLD SHORT OF (<i>position</i>);</p> <p>*e) HOLDING;</p> <p>*f) HOLDING SHORT.</p> <p>‡ Requires specific acknowledgement from the pilot.</p> <p>* Denotes pilot transmission. The procedure words ROGER and WILCO are insufficient acknowledgement of the instructions HOLD, HOLD POSITION and HOLD SHORT OF (<i>position</i>). In each case the acknowledgement shall be by the phraseology HOLDING or HOLDING SHORT, as appropriate.</p>
... to hold not closer to a runway than specified in Chapter 7, 7.5.3.1.3.1.	

<i>Circumstances</i>	<i>Phraseologies</i>
12.3.4.9 TO CROSS A RUNWAY	<p>*a) REQUEST CROSS RUNWAY (<i>number</i>);</p> <p><i>Note.</i>— <i>If the control tower is unable to see the crossing aircraft (e.g. night, low visibility, etc.), the instruction should always be accompanied by a request to report when the aircraft has vacated the runway.</i></p> <p>b) CROSS RUNWAY (<i>number</i>) [REPORT VACATED];</p> <p>c) EXPEDITE CROSSING RUNWAY (<i>number</i>) TRAFFIC (<i>aircraft type</i>) (<i>distance</i>) KILOMETRES (<i>or</i> MILES) FINAL;</p> <p>d) TAXI TO HOLDING POINT [<i>number</i>] [RUNWAY (<i>number</i>)] VIA (<i>specific route to be followed</i>), [HOLD SHORT OF RUNWAY (<i>number</i>)] or [CROSS RUNWAY (<i>number</i>)];</p> <p>*e) RUNWAY VACATED.</p> <p>* Denotes pilot transmission.</p>
<p><i>Note.</i> — <i>The pilot will, when requested, report “RUNWAY VACATED” when the entire aircraft is beyond the relevant runway-holding position.</i></p>	
12.3.4.10 PREPARATION FOR TAKE-OFF	<p>a) UNABLE TO ISSUE (<i>designator</i>) DEPARTURE (<i>reasons</i>);</p> <p>b) REPORT WHEN READY [FOR DEPARTURE];</p> <p>c) ARE YOU READY [FOR DEPARTURE]?;</p> <p>d) ARE YOU READY FOR IMMEDIATE DEPARTURE?;</p> <p>*e) READY;</p>
<p>... clearance to enter runway and await take-off clearance</p>	<p>f) LINE UP [AND WAIT];</p> <p>†g) LINE UP RUNWAY (<i>number</i>);</p> <p>h) LINE UP. BE READY FOR IMMEDIATE DEPARTURE;</p>

<i>Circumstances</i>	<i>Phraseologies</i>
... conditional clearances	‡i) (<i>condition</i>) LINE UP (<i>brief reiteration of the condition</i>);
... acknowledgement of a conditional clearance	*j) (<i>condition</i>) LINING UP (<i>brief reiteration of the condition</i>);
... confirmation or otherwise of the read-back of conditional clearance	k) [THAT IS] CORRECT (<i>or</i> NEGATIVE) [I SAY AGAIN] ... (<i>as appropriate</i>). * Denotes pilot transmission. † When there is the possibility of confusion during multiple runway operations. ‡ Provisions concerning the use of conditional clearances are contained in 12.2.4.
12.3.4.11 TAKE-OFF CLEARANCE	a) RUNWAY (<i>number</i>) CLEARED FOR TAKE-OFF [REPORT AIRBORNE];
... when reduced runway separation is used	b) (<i>traffic information</i>) RUNWAY (<i>number</i>) CLEARED FOR TAKE-OFF;
... when take-off clearance has not been complied with	c) TAKE OFF IMMEDIATELY OR VACATE RUNWAY [(<i>instructions</i>)];
... to cancel a take-off clearance	d) TAKE OFF IMMEDIATELY OR HOLD SHORT OF RUNWAY; e) HOLD POSITION, CANCEL TAKE-OFF I SAY AGAIN CANCEL TAKE-OFF (<i>reasons</i>); *f) HOLDING;
... to stop a take-off after an aircraft has commenced take-off roll	g) STOP IMMEDIATELY [(<i>repeat aircraft call sign</i>) STOP IMMEDIATELY]; *h) STOPPING;
... for helicopter operations	i) CLEARED FOR TAKE-OFF [FROM (<i>location</i>)] (<i>present position, taxiway, final approach and take-off area, runway and number</i>); *j) REQUEST DEPARTURE INSTRUCTIONS; k) AFTER DEPARTURE TURN RIGHT (<i>or</i> LEFT, <i>or</i> CLIMB) (<i>instructions as appropriate</i>). * Denotes pilot transmission. HOLDING and STOPPING are the procedural responses to e) and g) respectively.

<i>Circumstances</i>	<i>Phraseologies</i>
12.3.4.12 TURN OR CLIMB INSTRUCTIONS AFTER TAKE-OFF	*a) REQUEST RIGHT (<i>or</i> LEFT) TURN; b) RIGHT (<i>or</i> LEFT) TURN APPROVED; c) WILL ADVISE LATER FOR RIGHT (<i>or</i> LEFT) TURN;
... to request airborne time	d) REPORT AIRBORNE; e) AIRBORNE (<i>time</i>); f) AFTER PASSING (<i>level</i>) (<i>instructions</i>);
... heading to be followed	g) CONTINUE RUNWAY HEADING (<i>instructions</i>);
... when a specific track is to be followed	h) TRACK EXTENDED CENTRE LINE (<i>instructions</i>); i) CLIMB STRAIGHT AHEAD (<i>instructions</i>).
	* Denotes pilot transmission.
12.3.4.13 ENTERING AN AERODROME TRAFFIC CIRCUIT	*a) [<i>aircraft type</i>] (<i>position</i>) (<i>level</i>) FOR LANDING; b) JOIN [(<i>direction of circuit</i>)] (<i>position in circuit</i>) (<i>runway number</i>) [SURFACE] WIND (<i>direction and speed</i>) (<i>units</i>) [TEMPERATURE [MINUS] (<i>number</i>)] QNH (<i>or</i> QFE) (<i>number</i>) [(<i>units</i>)] [TRAFFIC (<i>detail</i>)]; c) MAKE STRAIGHT-IN APPROACH, RUNWAY (<i>number</i>) [SURFACE] WIND (<i>direction and speed</i>) (<i>units</i>) [TEMPERATURE [MINUS] (<i>number</i>)] QNH (<i>or</i> QFE) (<i>number</i>) [(<i>units</i>)] [TRAFFIC (<i>detail</i>)];
... when ATIS information is available	*d) (<i>aircraft type</i>) (<i>position</i>) (<i>level</i>) INFORMATION (<i>ATIS identification</i>) FOR LANDING; e) JOIN (<i>position in circuit</i>) [RUNWAY (<i>number</i>)] QNH (<i>or</i> QFE) (<i>number</i>) [(<i>units</i>)] [TRAFFIC (<i>detail</i>)].
	* Denotes pilot transmission.

<i>Circumstances</i>	<i>Phraseologies</i>
12.3.4.14 IN THE CIRCUIT	<p>*a) (<i>position in circuit, e.g.</i> DOWNWIND/FINAL);</p> <p>b) NUMBER ... FOLLOW (<i>aircraft type and position</i>) [<i>additional instructions if required</i>].</p> <p>* Denotes pilot transmission.</p>
12.3.4.15 APPROACH INSTRUCTIONS	<p>a) MAKE SHORT APPROACH;</p> <p>b) MAKE LONG APPROACH (<i>or</i> EXTEND DOWNWIND);</p> <p>c) REPORT BASE (<i>or</i> FINAL, <i>or</i> LONG FINAL);</p> <p>d) CONTINUE APPROACH [PREPARE FOR POSSIBLE GO AROUND].</p>
<p>12.3.4.16 LANDING CLEARANCE</p> <p>... when reduced runway separation is used</p> <p>... special operations</p> <p>... to make an approach along, or parallel to a runway, descending to an agreed minimum level</p> <p>... to fly past the control tower or other observation point for the purpose of visual inspection by persons on the ground</p>	<p>a) RUNWAY (<i>number</i>) CLEARED TO LAND;</p> <p>b) (<i>traffic information</i>) RUNWAY (<i>number</i>) CLEARED TO LAND;</p> <p>c) CLEARED TOUCH AND GO;</p> <p>d) MAKE FULL STOP;</p> <p>*e) REQUEST LOW APPROACH (<i>reasons</i>);</p> <p>f) CLEARED LOW APPROACH [RUNWAY (<i>number</i>)] [(<i>altitude restriction if required</i>) (<i>go around instructions</i>)];</p> <p>*g) REQUEST LOW PASS (<i>reasons</i>);</p> <p>h) CLEARED LOW PASS [<i>as in f</i>];</p>

<i>Circumstances</i>	<i>Phraseologies</i>
... for helicopter operations	<p>*i) REQUEST STRAIGHT-IN (<i>or</i> CIRCLING APPROACH, LEFT (<i>or</i> RIGHT) TURN TO (<i>location</i>));</p> <p>j) MAKE STRAIGHT-IN (<i>or</i> CIRCLING APPROACH, LEFT (<i>or</i> RIGHT) TURN TO (<i>location, runway, taxiway, final approach and take-off area</i>)) [ARRIVAL (<i>or</i> ARRIVAL ROUTE) (<i>number, name, or code</i>)]. [HOLD SHORT OF (<i>active runway, extended runway centre line, other</i>)]. [REMAIN (<i>direction or distance</i>) FROM (<i>runway, runway centre line, other helicopter or aircraft</i>)]. [CAUTION (<i>power lines, unlighted obstructions, wake turbulence, etc.</i>)]. CLEARED TO LAND.</p> <p>* Denotes pilot transmission.</p>
12.3.4.17 DELAYING AIRCRAFT	<p>a) CIRCLE THE AERODROME;</p> <p>b) ORBIT (RIGHT, <i>or</i> LEFT) [FROM PRESENT POSITION];</p> <p>c) MAKE ANOTHER CIRCUIT.</p>
12.3.4.18 MISSED APPROACH	<p>a) GO AROUND;</p> <p>*b) GOING AROUND.</p> <p>* Denotes pilot transmission.</p>
12.3.4.19 INFORMATION TO AIRCRAFT	<p>a) LANDING GEAR APPEARS DOWN;</p> <p>b) RIGHT (<i>or</i> LEFT, <i>or</i> NOSE) WHEEL APPEARS UP (<i>or</i> DOWN);</p> <p>c) WHEELS APPEAR UP;</p> <p>d) RIGHT (<i>or</i> LEFT, <i>or</i> NOSE) WHEEL DOES NOT APPEAR UP (<i>or</i> DOWN);</p>
... when pilot requested visual inspection of landing gear	

<i>Circumstances</i>	<i>Phraseologies</i>
... wake turbulence	e) CAUTION WAKE TURBULENCE [FROM ARRIVING (or DEPARTING) (type of aircraft)] [additional information as required];
For departing flights ATC will issue take-off clearance when the required wake turbulence separation minima will be achieved.	“(Callsign) hold position, (number) minutes delay due to wake turbulence”.
... jet blast on apron or taxiway	f) CAUTION JET BLAST;
... propeller-driven aircraft slipstream	g) CAUTION SLIPSTREAM.
12.3.4.20 RUNWAY VACATING AND COMMUNICATIONS AFTER LANDING	a) CONTACT GROUND (frequency); b) WHEN VACATED CONTACT GROUND (frequency); c) EXPEDITE VACATING; d) YOUR STAND (or GATE) (designation); e) TAKE (or TURN) FIRST (or SECOND, or CONVENIENT) LEFT (or RIGHT) AND CONTACT GROUND (frequency);
... for helicopter operations	f) AIR-TAXI TO HELICOPTER STAND (or) HELICOPTER PARKING POSITION (area); g) AIR-TAXI TO (or VIA) (location or routing as appropriate) [CAUTION (dust, blowing snow, loose debris, taxiing light aircraft, personnel, etc.)]; h) AIR TAXI VIA (direct, as requested, or specified route) TO (location, heliport, operating or movement area, active or inactive runway). AVOID (aircraft or vehicles or personnel).

12.3.5 Coordination between ATS units*Circumstances**Phraseologies*

12.3.5.1 ESTIMATES AND REVISIONS

<p>... sending unit</p> <p>... receiving unit reply (if flight plan details are not available)</p> <p>... receiving unit reply (if flight plan details are available)</p> <p>... sending unit reply</p>	<p>a) ESTIMATE [<i>direction of flight</i>] (<i>aircraft call sign</i>) [SQUAWKING (<i>SSR Code</i>)] (<i>type</i>) ESTIMATED (<i>significant point</i>) (<i>time</i>) (<i>level</i>) (or DESCENDING FROM (<i>level</i>) TO (<i>level</i>)) [SPEED (<i>filed TAS</i>)] (<i>route</i>) [REMARKS];</p> <p>b) ESTIMATE (<i>significant point</i>) ON (<i>aircraft call sign</i>);</p> <p>c) NO DETAILS;</p> <p>(<i>aircraft type</i>) (<i>destination</i>);</p> <p>[SQUAWKING (<i>SSR Code</i>)] [ESTIMATED] (<i>significant point</i>) (<i>time</i>) AT (<i>level</i>);</p> <p><i>Note.— In the event that flight plan details are not available the receiving station shall reply to b) NO DETAILS and transmitting station shall pass full estimate as in a).</i></p> <p>d) ESTIMATE UNMANNED FREE BALLOON(S) (<i>identification and classification</i>) ESTIMATED OVER (<i>place</i>) AT (<i>time</i>) REPORTED FLIGHT LEVEL(S) (<i>figure or figures</i>) [or FLIGHT LEVEL UNKNOWN] MOVING (<i>direction</i>) ESTIMATED GROUND SPEED (<i>figure</i>) (<i>other pertinent information, if any</i>);</p> <p>e) REVISION (<i>aircraft call sign</i>) (<i>details as necessary</i>).</p>
---	--

<i>Circumstances</i>	<i>Phraseologies</i>
12.3.5.2 TRANSFER OF CONTROL	<p>a) REQUEST RELEASE OF (<i>aircraft call sign</i>);</p> <p>b) (<i>aircraft call sign</i>) RELEASED [AT (<i>time</i>)] [<i>conditions/restrictions</i>];</p> <p>c) IS (<i>aircraft call sign</i>) RELEASED [FOR CLIMB (<i>or</i>) DESCENT];</p> <p>d) (<i>aircraft call sign</i>) NOT RELEASED [UNTIL (<i>time or significant point</i>)];</p> <p>e) UNABLE (<i>aircraft call sign</i>) [TRAFFIC IS (<i>details</i>)].</p>
12.3.5.3 CHANGE OF CLEARANCE	<p>a) MAY WE CHANGE CLEARANCE OF (<i>aircraft call sign</i>) TO (<i>details of alteration proposed</i>);</p> <p>b) AGREED TO (<i>alteration of clearance</i>) OF (<i>aircraft call sign</i>);</p> <p>c) UNABLE (<i>aircraft call sign</i>);</p> <p>d) UNABLE (<i>desired route, level, etc.</i>) [FOR (<i>aircraft call sign</i>)] [DUE (<i>reason</i>)] (<i>alternative clearance proposed</i>).</p>
12.3.5.4 APPROVAL REQUEST	<p>a) APPROVAL REQUEST (<i>aircraft call sign</i>) ESTIMATED DEPARTURE FROM (<i>significant point</i>) AT (<i>time</i>);</p> <p>b) (<i>aircraft call sign</i>) REQUEST APPROVED [(<i>restriction if any</i>)];</p> <p>c) (<i>aircraft call sign</i>) UNABLE (<i>alternative instructions</i>).</p>
12.3.5.5 INBOUND RELEASE	<p>[INBOUND RELEASE] (<i>aircraft call sign</i>) [SQUAWKING (<i>SSR Code</i>)] (<i>type</i>) FROM (<i>departure point</i>) RELEASED AT (<i>significant point, or time, or level</i>) CLEARED TO AND ESTIMATING (<i>clearance limit</i>) (<i>time</i>) AT (<i>level</i>) [EXPECTED APPROACH TIME <i>or</i> NO DELAY EXPECTED] CONTACT AT (<i>time</i>).</p>

<i>Circumstances</i>	<i>Phraseologies</i>
12.3.5.6 HANDOVER	HANDOVER (<i>aircraft call sign</i>) [SQUAWKING (<i>SSR code</i>)] POSITION (<i>aircraft position</i>) (<i>level</i>).
12.3.5.7 EXPEDITION OF CLEARANCE	a) EXPEDITE CLEARANCE (<i>aircraft call sign</i>) EXPECTED DEPARTURE FROM (<i>place</i>) AT (<i>time</i>); b) EXPEDITE CLEARANCE (<i>aircraft call sign</i>) [ESTIMATED] OVER (<i>place</i>) AT (<i>time</i>) REQUESTS (<i>level or route, etc.</i>).
12.3.5.8 REDUCED VERTICAL SEPARATION MINIMUM (RVSM) OPERATIONS	
... to verbally supplement estimate messages of aircraft non-approved for RVSM or to verbally supplement an automated estimate message exchange that does not automatically transfer information from Item 18 of the flight plan followed by supplementary information, as appropriate	a) NEGATIVE RVSM [(<i>supplementary information, e.g. State Aircraft</i>)];
... to communicate the cause of a contingency relating to an aircraft that is unable to conduct RVSM operations due to severe turbulence or other severe meteorological phenomena or equipment failure, as applicable	b) UNABLE RVSM DUE TURBULENCE (<i>or EQUIPMENT, as applicable</i>).

12.3.6 Phraseologies to be used related to CPDLC

12.3.6.1

failure of CPDLC	a) [ALL STATIONS] CPDLC FAILURE (<i>instructions</i>);
... failure of a single CPDLC message	b) CPDLC MESSAGE FAILURE (<i>appropriate clearance, instruction, information or request</i>);
... to correct CPDLC clearances, instructions, information or requests	c) DISREGARD CPDLC (<i>message type</i>) MESSAGE, BREAK (<i>correct clearance, instruction, information or request</i>);
... to instruct all stations or a specific flight to avoid sending CPDLC requests for a limited period of time	d) [ALL STATIONS] STOP SENDING CPDLC REQUESTS [UNTIL ADVISED] [(<i>reason</i>)];
... to resume normal use of CPDLC	e) [ALL STATIONS] RESUME NORMAL CPDLC OPERATIONS.

12.4 ATS SURVEILLANCE SERVICE PHRASEOLOGIES

Note.— The following comprise phraseologies specifically applicable when an ATS surveillance system is used in the provision of air traffic services. The phraseologies detailed in the sections above for use in the provision of air traffic services are also applicable, as appropriate, when an ATS surveillance system is used.

12.4.1 General ATS surveillance service phraseologies

<i>Circumstances</i>	<i>Phraseologies</i>
12.4.1.1 IDENTIFICATION OF AIRCRAFT	<ul style="list-style-type: none"> a) REPORT HEADING [AND FLIGHT LEVEL (or ALTITUDE)]; b) FOR IDENTIFICATION TURN LEFT (or RIGHT) HEADING (three digits); c) TRANSMIT FOR IDENTIFICATION AND REPORT HEADING; d) RADAR CONTACT [position]; e) IDENTIFIED [position]; f) NOT IDENTIFIED [reason], [RESUME (or CONTINUE) OWN NAVIGATION].
12.4.1.2 POSITION INFORMATION	POSITION (distance) (direction) OF (significant point) (or OVER or ABEAM (significant point)).
12.4.1.3 VECTORING INSTRUCTIONS	<ul style="list-style-type: none"> a) LEAVE (significant point) HEADING (three digits); b) CONTINUE HEADING (three digits); c) CONTINUE PRESENT HEADING; d) FLY HEADING (three digits); e) TURN LEFT (or RIGHT) HEADING (three digits) [reason]; f) TURN LEFT (or RIGHT) (number of degrees) DEGREES [reason]; g) STOP TURN HEADING (three digits); h) FLY HEADING (three digits), WHEN ABLE PROCEED DIRECT (name) (significant point); i) HEADING IS GOOD.

<i>Circumstances</i>	<i>Phraseologies</i>
12.4.1.4 TERMINATION OF VECTORING	a) RESUME OWN NAVIGATION (<i>position of aircraft</i>) (<i>specific instructions</i>); b) RESUME OWN NAVIGATION [DIRECT] (<i>significant point</i>) [MAGNETIC TRACK (<i>three digits</i>) DISTANCE (<i>number</i>) KILOMETRES (<i>or MILES</i>)].
12.4.1.5 MANOEUVRES ... (in case of unreliable directional instruments on board aircraft)	a) MAKE A THREE SIXTY TURN LEFT (<i>or RIGHT</i>) [<i>reason</i>]; b) ORBIT LEFT (<i>or RIGHT</i>) [<i>reason</i>]; c) MAKE ALL TURNS RATE ONE (<i>or RATE HALF, or (number) DEGREES PER SECOND</i>) START AND STOP ALL TURNS ON THE COMMAND “NOW”; d) TURN LEFT (<i>or RIGHT</i>) NOW; e) STOP TURN NOW.
<i>Note.— When it is necessary to specify a reason for vectoring or for the above manoeuvres, the following phraseologies should be used:</i> a) DUE TRAFFIC; b) FOR SPACING; c) FOR DELAY; d) FOR DOWNWIND (<i>or BASE, or FINAL</i>).	
12.4.1.6 SPEED CONTROL	a) REPORT SPEED; *b) SPEED (<i>number</i>) KILOMETRES PER HOUR (<i>or KNOTS</i>); c) MAINTAIN (<i>number</i>) KILOMETRES PER HOUR (<i>or KNOTS</i>) [OR GREATER (<i>or OR LESS</i>)] [UNTIL (<i>significant point</i>)]; d) DO NOT EXCEED (<i>number</i>) KILOMETRES PER HOUR (<i>or KNOTS</i>); e) MAINTAIN PRESENT SPEED; f) INCREASE (<i>or REDUCE</i>) SPEED TO (<i>number</i>) KILOMETRES PER HOUR (<i>or KNOTS</i>) [OR GREATER (<i>or OR LESS</i>)];

*Circumstances**Phraseologies*

- g) INCREASE (*or* REDUCE) SPEED BY (*number*) KILOMETRES PER HOUR (*or* KNOTS);
- h) RESUME NORMAL SPEED;
- i) REDUCE TO MINIMUM APPROACH SPEED;
- j) REDUCE TO MINIMUM CLEAN SPEED;
- k) NO [ATC] SPEED RESTRICTIONS.
- * Denotes pilot transmission.

12.4.1.7 POSITION REPORTING

... to omit position reports

- a) OMIT POSITION REPORTS [UNTIL (*specify*)];
- b) NEXT REPORT AT (*significant point*);
- c) REPORTS REQUIRED ONLY AT (*significant point(s)*);
- d) RESUME POSITION REPORTING.

12.4.1.8 TRAFFIC INFORMATION AND AVOIDING ACTION

- a) TRAFFIC (*number*) O’CLOCK (*distance*) (*direction of flight*) [*any other pertinent information*];
- 1) UNKNOWN;
- 2) SLOW MOVING;
- 3) FAST MOVING;
- 4) CLOSING;
- 5) OPPOSITE (*or* SAME) DIRECTION;
- 6) OVERTAKING;
- 7) CROSSING LEFT TO RIGHT (*or* RIGHT TO LEFT);
- 8) (*aircraft type*);
- 9) (*level*);
- 10) CLIMBING (*or* DESCENDING);
- *b) REQUEST VECTORS;
- c) DO YOU WANT VECTORS?;

... (if known)

... to request avoiding action

<i>Circumstances</i>	<i>Phraseologies</i>
... when passing unknown traffic	d) CLEAR OF TRAFFIC [<i>appropriate instructions</i>];
... for avoiding action	e) TURN LEFT (<i>or</i> RIGHT) IMMEDIATELY HEADING (<i>three digits</i>) TO AVOID [UNIDENTIFIED] TRAFFIC (<i>bearing by clock-reference and distance</i>); f) TURN LEFT (<i>or</i> RIGHT) (<i>number of degrees</i>) DEGREES IMMEDIATELY TO AVOID [UNIDENTIFIED] TRAFFIC AT (<i>bearing by clock-reference and distance</i>).
	* Denotes pilot transmission.
12.4.1.9 COMMUNICATIONS AND LOSS OF COMMUNICATIONS	a) [IF] RADIO CONTACT LOST (<i>instructions</i>); b) IF NO TRANSMISSIONS RECEIVED FOR (<i>number</i>) MINUTES (<i>or</i> SECONDS) (<i>instructions</i>); c) REPLY NOT RECEIVED (<i>instructions</i>);
... if loss of communications suspected	d) IF YOU READ [<i>manoeuvre instructions or SQUAWK (code or IDENT)</i>]; e) (<i>manoeuvre, SQUAWK or IDENT</i>) OBSERVED. POSITION (<i>position of aircraft</i>). [<i>instructions</i>].
12.4.1.10 TERMINATION OF RADAR AND/OR ADS-B SERVICE	a) RADAR SERVICE (<i>or</i> IDENTIFICATION) TERMINATED [DUE (<i>reason</i>)] (<i>instructions</i>); b) WILL SHORTLY LOSE IDENTIFICATION (<i>appropriate instructions or information</i>); c) IDENTIFICATION LOST [<i>reasons</i>] (<i>instructions</i>).

<i>Circumstances</i>	<i>Phraseologies</i>
12.4.1.11 RADAR AND/OR ADS-B EQUIPMENT DEGRADATION	a) SECONDARY RADAR OUT OF SERVICE <i>(appropriate information as necessary);</i> b) PRIMARY RADAR OUT OF SERVICE <i>(appropriate information as necessary).</i> c) ADS-B OUT OF SERVICE (appropriate information as necessary).
12.4.2 Radar in approach control service	
12.4.2.1 VECTORING FOR APPROACH	a) VECTORING FOR <i>(type of pilot-interpreted aid)</i> APPROACH RUNWAY <i>(number)</i> ; b) VECTORING FOR VISUAL APPROACH RUNWAY <i>(number)</i> REPORT FIELD <i>(or RUNWAY)</i> IN SIGHT; c) VECTORING FOR <i>(positioning in the circuit)</i> ; d) <i>(type)</i> APPROACH NOT AVAILABLE DUE <i>(reason)</i> <i>(alternative instructions)</i> .
12.4.2.2 VECTORING FOR ILS AND OTHER PILOT-INTERPRETED AIDS	a) POSITION <i>(number)</i> MILES from <i>(fix)</i> . TURN LEFT <i>(or RIGHT)</i> HEADING <i>(three digits)</i> ; b) YOU WILL INTERCEPT <i>(radio aid or track)</i> <i>(distance)</i> FROM <i>(significant point or TOUCHDOWN)</i> ; *c) REQUEST <i>(distance)</i> FINAL; d) CLEARED FOR <i>(type of approach)</i> APPROACH RUNWAY <i>(number)</i> ; e) REPORT ESTABLISHED ON [ILS] LOCALIZER <i>(or ON GBAS/SBAS/MLS APPROACH COURSE)</i> ; f) CLOSING FROM LEFT <i>(or RIGHT)</i> [REPORT ESTABLISHED];
... when a pilot wishes to be positioned a specific distance from touchdown	*c) REQUEST <i>(distance)</i> FINAL; d) CLEARED FOR <i>(type of approach)</i> APPROACH RUNWAY <i>(number)</i> ; e) REPORT ESTABLISHED ON [ILS] LOCALIZER <i>(or ON GBAS/SBAS/MLS APPROACH COURSE)</i> ; f) CLOSING FROM LEFT <i>(or RIGHT)</i> [REPORT ESTABLISHED];
... instructions and information	e) REPORT ESTABLISHED ON [ILS] LOCALIZER <i>(or ON GBAS/SBAS/MLS APPROACH COURSE)</i> ; f) CLOSING FROM LEFT <i>(or RIGHT)</i> [REPORT ESTABLISHED];

*Circumstances**Phraseologies*

g) TURN LEFT (*or* RIGHT) HEADING (*three digits*) [TO INTERCEPT] *or* [REPORT ESTABLISHED];

h) EXPECT VECTOR ACROSS (*localizer course or radio aid*) (*reason*);

i) THIS TURN WILL TAKE YOU THROUGH (*localizer course or radio aid*) [*reason*];

j) TAKING YOU THROUGH (*localizer course or radio aid*) [*reason*];

k) MAINTAIN (*altitude*) UNTIL GLIDE PATH INTERCEPTION;

l) REPORT ESTABLISHED ON GLIDE PATH;

m) INTERCEPT (*localizer course or radio aid*) [REPORT ESTABLISHED].

* Denotes pilot transmission.

12.4.2.3 MANOEUVRE DURING
INDEPENDENT AND
DEPENDENT PARALLEL
APPROACHES

a) CLEARED FOR (*type of approach*)
APPROACH RUNWAY (*number*) LEFT (*or*
RIGHT);

b) YOU HAVE CROSSED THE LOCALIZER
(*or* GBAS/SBAS/MLS FINAL APPROACH
COURSE). TURN LEFT (*or* RIGHT)
IMMEDIATELY AND RETURN TO THE
LOCALIZER (*or* GBAS/SBAS/MLS FINAL
APPROACH COURSE);

c) ILS (*or* MLS) RUNWAY (*number*) LEFT (*or*
RIGHT) LOCALIZER (*or* MLS) FREQUENCY
IS (*frequency*);

d) TURN LEFT (*or* RIGHT) (*number*)
DEGREES (*or* HEADING) (*three digits*)
IMMEDIATELY TO AVOID TRAFFIC
[DEVIATING FROM ADJACENT
APPROACH], CLIMB TO (*altitude*);

... for avoidance action when
an aircraft is observed
penetrating the NTZ

<i>Circumstances</i>	<i>Phraseologies</i>
... for avoidance action below 120 m (400 ft) above the runway threshold elevation where parallel approach obstacle assessment surfaces (PAOAS) criteria are being applied	e) CLIMB TO (<i>altitude</i>) IMMEDIATELY TO AVOID TRAFFIC [DEVIATING FROM ADJACENT APPROACH] (<i>further instructions</i>).
12.4.2.4 SURVEILLANCE RADAR APPROACH	[RESERVED]
12.4.2.5 PAR APPROACH	[RESERVED]
12.4.3 Secondary surveillance radar (SSR) and ADS-B phraseologies	
12.4.3.1 TO REQUEST THE CAPABILITY OF THE SSR EQUIPMENT	a) ADVISE TRANSPONDER CAPABILITY; *b) TRANSPONDER (<i>as shown in the flight plan</i>); *c) NEGATIVE TRANSPONDER. * Denotes pilot transmission.
12.4.3.2 TO REQUEST THE CAPABILITY OF THE ADS-B EQUIPMENT	a) ADVISE ADS-B CAPABILITY; *b) ADS-B TRANSMITTER (<i>data link</i>); *c) ADS-B RECEIVER (<i>data link</i>); *d) NEGATIVE ADS-B. * Denotes pilot transmission
12.4.3.3 TO INSTRUCT SETTING OF TRANSPONDER	a) FOR DEPARTURE SQUAWK (<i>code</i>); b) SQUAWK (<i>code</i>).
12.4.3.4 TO REQUEST THE PILOT TO RESELECT THE ASSIGNED MODE AND CODE	a) RESET SQUAWK [(<i>mode</i>)] (<i>code</i>); *b) RESETTING (<i>mode</i>) (<i>code</i>). * Denotes pilot transmission.
12.4.3.5 TO REQUEST RESELECTION OF AIRCRAFT IDENTIFICATION	RE-ENTER [ADS-B <i>or</i> MODE S] AIRCRAFT IDENTIFICATION.
12.4.3.6 TO REQUEST THE PILOT TO CONFIRM THE CODE SELECTED ON THE AIRCRAFT'S TRANSPONDER	a) CONFIRM SQUAWK (<i>code</i>); *b) SQUAWKING (<i>code</i>). * Denotes pilot transmission.

<i>Circumstances</i>	<i>Phraseologies</i>
12.4.3.7 TO REQUEST THE OPERATION OF THE IDENT FEATURE	a) SQUAWK [(code)] [AND] IDENT; b) SQUAWK LOW; c) SQUAWK NORMAL. d) TRANSMIT ADS-B IDENT.
12.4.3.8 TO REQUEST TEMPORARY SUSPENSION OF TRANSPONDER OPERATION	SQUAWK STANDBY.
12.4.3.9 TO REQUEST EMERGENCY CODE	SQUAWK MAYDAY [CODE SEVEN-SEVEN-ZERO-ZERO].
12.4.3.10 TO REQUEST TERMINATION OF TRANSPONDER AND/OR ADS-B TRANSMITTER OPERATION	a) STOP SQUAWK [TRANSMIT ADS-B ONLY]; b) STOP ADS-B TRANSMISSION [SQUAWK (code) ONLY].
<i>Note.— Independent operations of Mode S transponder and ADS-B may not be possible in all aircraft (e.g. where ADS-B is solely provided by 1 090 MHz extended squitter emitted from the transponder). In such cases, aircraft may not be able to comply with ATC instructions related to ADS-B operation.</i>	
12.4.3.11 TO REQUEST TRANSMISSION OF PRESSURE ALTITUDE	a) SQUAWK CHARLIE; b) TRANSMIT ADS-B ALTITUDE.
12.4.3.12 TO REQUEST PRESSURE SETTING CHECK AND CONFIRMATION OF LEVEL	CHECK ALTIMETER SETTING AND CONFIRM (level).
12.4.3.13 TO REQUEST TERMINATION OF PRESSURE ALTITUDE TRANSMISSION BECAUSE OF FAULTY OPERATION	a) STOP SQUAWK CHARLIE WRONG INDICATION; b) STOP ADS-B ALTITUDE TRANSMISSION [(WRONG INDICATION, or reason)].
<i>Note.— See Note to paragraph 12.4.3.10.</i>	
12.4.3.14 TO REQUEST LEVEL CHECK	CONFIRM (level).

12.5 AUTOMATIC DEPENDENT SURVEILLANCE — CONTRACT (ADS-C) PHRASEOLOGIES

12.5.1 General ADS-C phraseologies

<i>Circumstances</i>	<i>Phraseologies</i>
12.5.1.1 ADS-C DEGRADATION	ADS-C (or ADS-CONTRACT) OUT OF SERVICE (<i>appropriate information as necessary</i>).

12.6 ALERTING PHRASEOLOGIES

12.6.1 Alerting phraseologies

12.6.1.1 LOW ALTITUDE WARNING	(<i>aircraft call sign</i>) LOW ALTITUDE WARNING, CHECK YOUR ALTITUDE IMMEDIATELY, QNH IS (<i>number</i>) [(<i>units</i>)]. [THE MINIMUM FLIGHT ALTITUDE IS (<i>altitude</i>)].
12.6.1.2 TERRAIN ALERT	(<i>aircraft call sign</i>) TERRAIN ALERT, (<i>suggested pilot action, if possible</i>).

12.7 GROUND CREW/FLIGHT CREW PHRASEOLOGIES

12.7.1 Ground crew/flight crew phraseologies

12.7.1.1 STARTING PROCEDURES (GROUND CREW/COCKPIT)	<p>a) [ARE YOU] READY TO START UP; *b) STARTING NUMBER (<i>engine number(s)</i>).</p> <p><i>Note 1.— The ground crew should follow this exchange by either a reply on the intercom or a distinct visual signal to indicate that all is clear and that the start-up as indicated may proceed.</i></p> <p><i>Note 2.— Unambiguous identification of the parties concerned is essential in any communications between ground crew and pilots.</i></p>
--	--

* Denotes pilot transmission.

*Circumstances**Phraseologies*

12.7.1.2 PUSHBACK PROCEDURES

... (ground crew/cockpit)

- a) ARE YOU READY FOR PUSHBACK;
- *b) READY FOR PUSHBACK;
- c) CONFIRM BRAKES RELEASED;
- *d) BRAKES RELEASED;
- e) COMMENCING PUSHBACK;
- f) PUSHBACK COMPLETED;
- *g) STOP PUSHBACK;
- h) CONFIRM BRAKES SET;
- *i) BRAKES SET;
- *j) DISCONNECT;
- k) DISCONNECTING STAND BY FOR VISUAL AT YOUR LEFT (*or* RIGHT).

Note.— This exchange is followed by a visual signal to the pilot to indicate that disconnect is completed and all is clear for taxiing.

* Denotes pilot transmission.

CHAPTER 13

AUTOMATIC DEPENDENT SURVEILLANCE – CONTRACT (ADS-C) SERVICES

Note 1 - Singapore adopts the FANS-1/A procedures and requirements for the use of data link applications contain in the FANS-1/A Operations Manual (FOM), which has been adopted by ICAO for Regional use.

Note 2 - ADS-contract (ADS-C), at this time is used wholly to provide procedural separation.

13.1 GENERAL

13.1.1 The provision of air traffic services to aircraft, based on information received from aircraft via ADS-C, is generally referred to as the provision of ADS-C services.

13.2 ADS-C GROUND SYSTEM CAPABILITIES

13.2.1 ADS-C ground systems used in the provision of air traffic services shall have a high level of reliability, availability and integrity. Back-up facilities shall be provided.

Note 1— An ADS-C ground system will normally consist of a number of integrated elements, including communication interfaces, a data processing system and one or more controller interfaces.

13.2.2 ADS-C ground systems should be capable of integration with other automated systems used in the provision of ATS and should provide for an appropriate level of automation with the objectives of improving the accuracy and timeliness of data displayed to the controller and reducing controller workload and the need for verbal coordination between adjacent control positions and ATC units.

13.2.3 Several significant functional requirements are necessary to permit the effective implementation of an ADS-C service in a CNS/ATM environment. Ground systems shall provide for:

- a) the transmitting, receiving, processing and displaying of ADS-C messages related to flights equipped for and operating within environments where ADS-C services are being provided;
- b) the display of safety-related alerts and warnings;
- c) position monitoring (the aircraft's current position as derived from ADS-C reports is displayed to the controller for air traffic situation monitoring);

d) conformance monitoring (the ADS-C reported current position or projected profile is compared to the expected aircraft position, which is based on the current flight plan. Along track, lateral and vertical deviations that exceed a pre-defined tolerance limit will permit an out-of-conformance alert to be issued to the controller);

e) flight plan update (e.g. longitudinal variations that exceed pre-defined tolerance limits will be used to adjust expected arrival times at subsequent fixes);

f) intent validation (intent data contained in ADS-C reports, such as extended projected profile, are compared with the current clearance and discrepancies are identified);

Note.— The use of ADS-C does not relieve the controller of the obligation to continuously monitor the traffic situation.

13.2.4 Air traffic control facilities providing an ADS-C service shall be capable of storing and disseminating specific flight information relating to flights equipped for and operating within environments where an ADS service is provided.

13.2.5 Effective human-machine interfaces shall exist for the controller to permit appropriate utilization of the ADS-C-derived information and associated automated features.

13.3 ADS-C-RELATED AERONAUTICAL INFORMATION

13.3.1 Adequate information on the operating practices having a direct effect on the operations of air traffic services shall be published in aeronautical information publications. This shall include a brief description concerning the area of responsibility, requirements and conditions under which the ADS-C service is available, equipment limitations, ADS-C failure procedures, if required, and the initial address(es) for each ATC unit.

13.4 ADS-C PROCEDURES

13.4.1 General

13.4.1.1 ADS-C allows the establishment of communication contracts between ground systems and an aircraft's avionics system. An ADS-C contract contains the ATC data requirements for ADS reporting as well as frequency of the ADS reports. The implementation of ADS-C provides surveillance capability in oceanic and en-route continental airspace and is intended to replace CPDLC and verbal position reporting in areas where non-radar separation is currently applied. In non-radar airspace, the effective use of ADS-C in the provision of air traffic services enhances flight safety, facilitates the reduction of separation minima and better accommodates user-preferred flight profiles.

13.4.2 ADS-C Description

13.4.2A Three types of ADS-C contracts can be established with an aircraft. Each of these contracts operates independently from the others. These contracts are the:

- Periodic;
- Event; and
- Demand.

The establishment of ADS-C contracts is initiated by the ground system and does not require pilot action providing that the airborne system is armed. The pilot has the ability to cancel all contracts by selecting ADS off.

13.4.2.1 The periodic contract

13.4.2.1.1 The periodic contract allows an ATS unit (ATSU) to specify the reporting frequency, to request that optional data groups be added to the basic ADS-C report, and to specify the frequency at which the optional groups are to be included in the reports. The periodic reporting rate can generally be altered by the controller to allow for situations where a higher or lower reporting rate may be required. Only one periodic contract can be established between a ground system and a particular aircraft at any one time. Whenever a new periodic contract is established, the previous periodic contract is replaced. The periodic contract will remain in effect until it is modified or cancelled.

13.4.2.2 The event contract

13.4.2.2.1 An event contract specifies a request for reports to be transmitted by the aircraft whenever a defined “event” occurs. Only one event contract can be established between a ground system and a particular aircraft at any one time, however the event contract can contain multiple event types.

Note that multiple ATSUs with ADS-C connections can each establish their own event contracts with an aircraft. Once an event contract has been established, it remains in effect until the specific event requests are fulfilled, or it is cancelled by the ground system.

The **Vertical Rate Change Event** is triggered when the aircraft’s vertical rate is either less than or greater than a parameter defined in the contract.

The **Lateral Deviation Change Event** is triggered when the aircraft’s actual position exceeds a lateral distance parameter from the aircraft’s expected position on the active flight plan.

The **Altitude Range Change Event** is triggered when the aircraft’s altitude exceeds the altitude ceiling or floor defined in the contract by the ground system. Once a vertical rate change, lateral deviation change, or altitude range event trigger has occurred, a recurrence of this event no longer triggers an event report. The ground system must initiate a new event contract every time that one of these specific events occurs.

The **Waypoint Change Event** is triggered by a change to the next or the next-plus-one waypoints. Such a change normally occurs due to routine waypoint sequencing. However, it will also be triggered by occurrences such as a change to a non-ATS waypoint entered by the pilot for operational reasons, or execution of a new route affecting the next or next-plus-one waypoints. Unlike the other event contracts, the waypoint change event trigger remains in effect for all waypoint changes.

13.4.2.3 The demand contract

13.4.2.3.1 The demand contract is a “one-off” request from the ground system for the flight management system to provide an ADS report containing specific data as defined in the request. A demand contract can be requested by the ground system at any time. The demand contract request will not affect any existing contracts.

13.4.2.4 Emergency mode

13.4.2.4.1 The emergency mode can only be activated by the pilot and is normally cancelled by the pilot. While it is possible for some ground systems to cancel the emergency mode status, most ground systems do not have this capability although some ground systems can control the “display” of the emergency mode status to the controller. The pilot normally activates the ADS emergency mode automatically by sending a CPDLC MAYDAY message, although the ADS emergency mode can also be set independently. When the ADS emergency mode is set, the aircraft immediately sends an ADS report containing an emergency flag that is interpreted by all ground systems that currently have periodic or event contracts established with that aircraft. The aircraft does not automatically send an ADS report at the time that the emergency mode is set.

13.4.2.4.2 When the pilot cancels the emergency mode, the aircraft will send an emergency mode cancellation message to each ground station receiving the emergency mode reports with the next periodic report, whenever it may be due. The cancellation message will remove the emergency flag from the periodic contract, but the data contents will remain the same as per the emergency contract. Any previously existing data groups requested by the ground system will not be restored unless the ground system re-negotiates the periodic contract following receipt of the emergency cancellation message. Existing event contracts are unaffected by the emergency cancellation.

13.5 Factors To Be Considered When Using ADS-C

13.5.1 Vertical and lateral variations

13.5.1.1 Where the Altitude Range Change Event and Lateral Deviation Event contracts are established, the controller will only be alerted to vertical or lateral variations that exceed the associated tolerances.

Note: If a regular periodic report is sent as the aircraft is deviating from cleared level or route (but still within the level or lateral tolerances) the controller will still be alerted to the variation despite no event report having been sent.

13.6 ADS-C Connection Management

13.6.1 Priority for the ADS-C connection

13.6.1A FANS-1/A equipped aircraft can have up to five ADS-C connections. One of the five connections is reserved for use by the Airline Operational Communications (AOC). The aircraft has the capacity to report to four different ATSU's simultaneously using ADS.

13.6.1B The FANS-1/A system does not assign any technical priority to ADS-C connections; therefore the controlling ATSU may not be aware of other connections established with the aircraft.

13.6.1.1 Allocation of ADS-C connections

13.6.1.1.1 Using the Address Forwarding process, the current controlling authority shall allocate ADS-C connection priority to the next ATSU that will have air traffic control responsibility for the aircraft. The priority for the allocation of ADS-C connections shall be in accordance with the following list:

- (a) The Current Data Authority,
- (b) The Next Data Authority,
- (c) An ATSU requiring a connection for monitoring operations close to a boundary,
- (d) Airline AOC
- (e) Other miscellaneous connections.

13.6.2 Near boundary ADS-C connections

13.6.2.1 Monitoring of an aircraft operating close to an airspace boundary

13.6.2.1.1 When an aircraft will operate within the defined coordination parameter of the boundary with an adjacent ADS-C capable FIR, controllers shall determine during coordination whether that ATSU requires an ADS-C contract to monitor the aircraft's progress near the boundary.

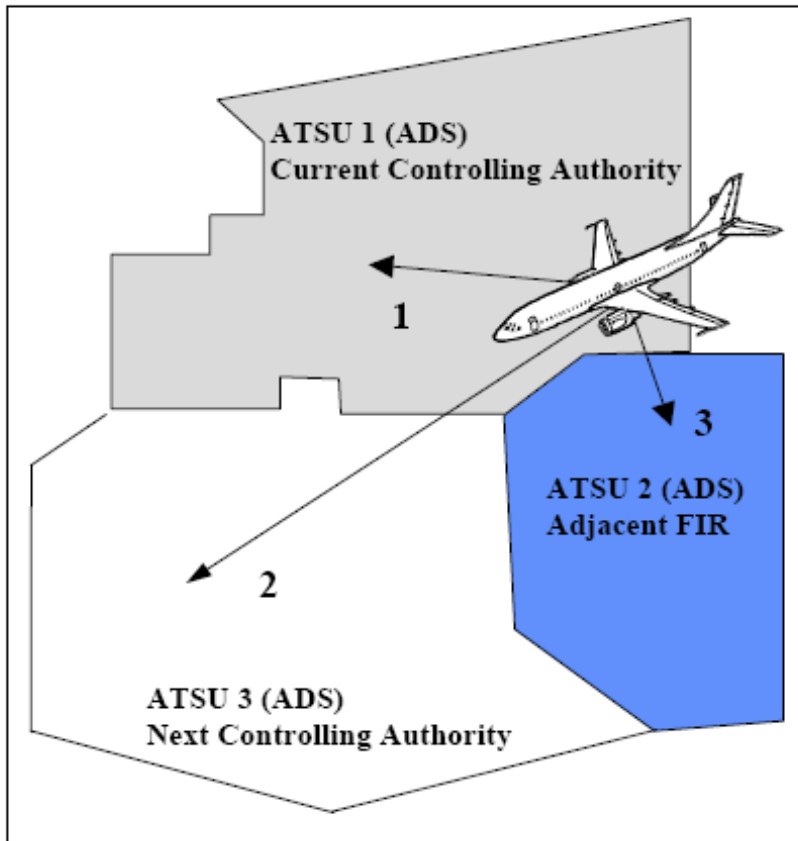

Priorities for ADS-C connections

An ADS-C contract is required by ATSU 2 to monitor the aircraft's progress near the FIR boundary. To ensure that the next unit with direct control responsibility for the aircraft has priority over the ADS-C connections, Address Forwarding to ATSU 3 will be initiated by ATSU 1 prior to Address Forwarding to ATSU 2.

13.6.2.2 Other ground facilities requesting ADS-C contracts

13.6.2.2.1 All ground facilities, without having direct control or monitoring requirements for that aircraft, seeking an ADS-C contract with a specific aircraft (e.g. for ADS-C test purposes) must coordinate with the controlling authorities and the operator prior to the departure of the flight.

13.6.3 ADS-C connections not available

13.6.3.1 When all available ADS-C connections with a particular aircraft have been established, any other ATSU attempting to connect with the aircraft will receive an ADS DISCONNECT REQUEST message with "reason code 1" (Congestion).

13.6.3.2 When ADS DISCONNECT REQUEST is received by an ATSU, which would normally have priority for an ADS-C connection, the current controlling authority should be notified. The controlling authority shall resolve the situation.

13.6.3.3 The controlling authority has a number of options available, such as coordination with the previous ATSU or other adjacent ATSUs to ensure that existing ADS-C connections are still required, or when considered absolutely necessary, instructing the pilot to turn the ADS application off and turn it on again. The latter option will terminate all current ADS-C contracts; therefore, the controlling authority should consider the operational effect on other ATSUs prior to employing this method.

13.6.3.4 Once all contracts have been terminated, the controlling authority shall allocate priority for the connections to other ATSUs via the Address Forwarding process. Only ATSUs with direct control or monitoring responsibilities shall re-establish contracts with the aircraft.

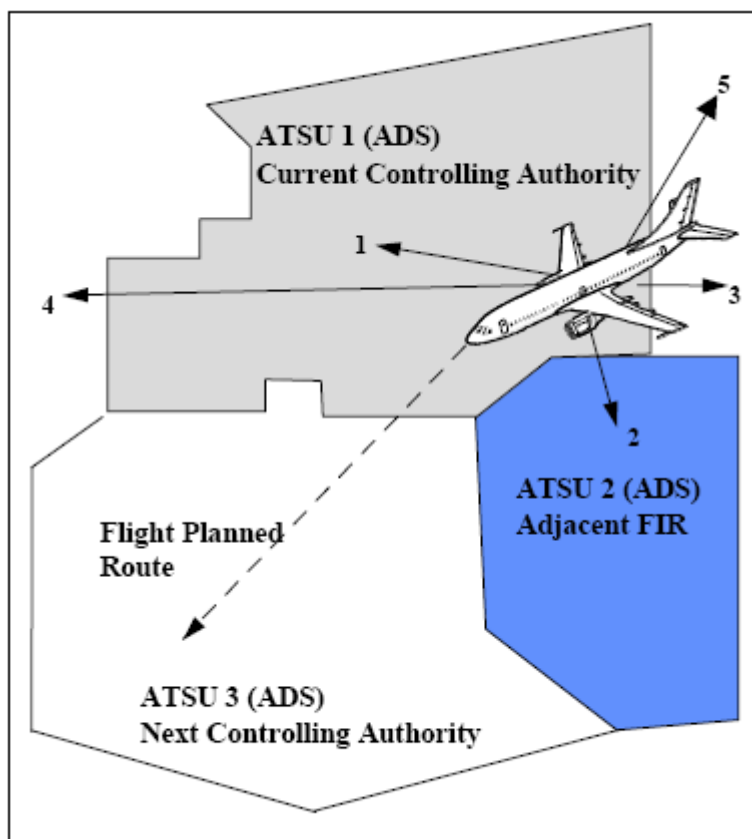

ADS-C connection not available

*The aircraft has ADS-C connections with four ground facilities and the airline AOC:
Connection:*

- 1 - with ATSU 1,
- 2 - with ATSU 2,
- 3 - with the previous controlling authority,
- 4 - with the airline AOC,
- 5 - with a ground facility collecting test data.

ATSU 3, the next controlling authority, is unable to establish an ADS-C connection with the aircraft due to congestion.

13.6.4 Ground system termination of ADS-C connections

13.6.4.1 ADS-C contracts and connections should be terminated by the ground system when the:

- (a) Aircraft has crossed an FIR boundary and has passed beyond the normal “back coordination” parameter; or
- (b) The ground system’s FDPS flight plan for the aircraft has been cancelled or has finished; or
- (c) Previous ATSU, the controlling authority or an adjacent ATSU has no further surveillance or monitoring requirements for a particular flight.

13.7 Reporting Rates

13.7.1 General

13.7.1.1 There are a number of situations where a controller may consider the use of a reporting rate other than that used as the default in the periodic reporting contract. Some automated systems have the capability of defining reporting rates that can automatically change from one area to another along the route segment to take into account changes in traffic density along the route.

13.7.2 Appropriate reporting rates

13.7.2.1 ATSUs should ensure that the periodic reporting rate in use is in accordance with the position reporting requirements of the separation standards being used.

13.7.3 Avoid high periodic reporting rates

13.7.3.1 ATSU shall avoid high periodic reporting rates which adds undue economic costs and unnecessarily loading to the data link system.

13.7.4 Other factors to be considered

13.7.4.1 Depending on individual circumstances the ANSP should limit the periodic reporting rate to not more frequently than five (5) minutes. Adjacent ATSUs with ADS-C contracts established with the same aircraft should restrict the periodic reporting rate to not more frequently than 15 minutes unless coordination is performed with the ANSP and the ANSP agrees to reduce any relatively high reporting rate currently in effect.

13.7.5 Default periodic reporting rates

13.7.5.1 When setting a default periodic reporting rate, ATSUs should take into account factors such as conformance with ATC clearance requirements, traffic levels, alerting service requirements, and separation standard requirements.

13.8 Separation

ADS-C may be used for the application of procedural separation within a mixed surveillance environment, such as airspace where position reports are provided by a mixture of ADS-C, CPDLC and voice.

For example, ADS-C may be used to determine separation between two or more aircraft reporting by ADS-C, between ADS-C and non-ADS aircraft, between ADS-C aircraft and an aircraft identified on radar, and to ensure separation between ADS-C aircraft and special use airspace, such as military restricted areas.

13.8.1 Appropriate ADS-C reporting requirements

13.8.1.1 When position reporting is being provided via ADS-C, to ensure that estimates being used for the application of separation are accurate ATSU's should establish appropriate:

- (a) ADS-C contracts; and
- (b) Periodic reporting frequencies.

13.8.2 Appropriate separation standard

13.8.2.1 A separation standard to be applied in a mixed surveillance environment must be appropriate to the communications and navigational capability of the relevant aircraft. In the case of separation being applied between ADS-C and non-ADS aircraft, the separation standard must be appropriate to the capabilities of the non-ADS aircraft.

13.8.3 Vertical separation

13.8.3.1 Vertical tolerance consistency

13.8.3.1.1 Where practical, the tolerances used to determine whether a specific level is occupied by an ADS-C reporting aircraft within the airspace of a specific ATSU should be consistent with other tolerances used throughout the airspace. For example, the vertical tolerances for ADS-C should be consistent with vertical tolerances used for level adherence monitoring by other forms of surveillance, such as radar.

13.8.3.2 Application of vertical tolerances

13.8.3.2.1 Where other vertical tolerances do not exist, the vertical tolerances to be applied for ADS-C shall be (\pm) 300 feet. However, an individual ATSU may specify in local instructions and the AIP that a tolerance of not less than (\pm) 200 feet will be used to provide consistency with other vertical tolerances applied within the FIR.

13.8.3.3 ADS-C level information does not satisfy vertical tolerance

13.8.3.3.1 If displayed ADS-C level information does not satisfy the required tolerance for an individual ATSU then the pilot shall be advised accordingly and requested to confirm the aircraft's level. If following confirmation of the level the displayed ADS-C level information is still beyond the required tolerance, another method of separation or another method of determining level information may need to be applied.

13.8.3.4 Use of ADS-C level information

13.8.3.4.1 When displayed ADS-C level information is within the specified tolerance of the expected or cleared flight level, the ADS-C level information may be used for the application of vertical separation, and to determine that an aircraft has reached or is maintaining a specified level.

13.8.3.5 Passing or leaving a level

13.8.3.5.1 An aircraft can be considered to have left a specified level when the displayed ADS-C level information indicates that the aircraft has passed the level in the required direction by more than the required tolerance.

13.8.4 Longitudinal separation

13.8.4.1 Limitations on the use of tools

13.8.4.1.1 ATSUs that use approved or integrated measurement tools for the purpose of determining screen-based separation should publish in local documentation any limitations on the use of such tools for the establishment and monitoring of separation standards.

13.8.4.2 Establishing longitudinal separation

13.8.4.2.1 ADS-C reports may be used to establish and monitor longitudinal time and distance separation standards.

13.8.4.3 Using extrapolated or interpolated positions

13.8.4.3.1 Some ground systems display an extrapolated or interpolated ADS symbol between the receipt of ADS-C reports. Providing that the periodic reporting rate in use is in accordance with any reporting rate required by the separation standard, separation may be determined between the extrapolated/interpolated symbols by the use of screen-based measurement tools, or by the use of automated conflict detection tools.

13.8.4.4 Validity of displayed information

13.8.4.4.1 When extrapolated or interpolated ADS symbols are being used to provide separation and any doubt exists as to the integrity or validity of the information being presented, the controller shall send a Demand Contract Request to update the relevant information. If doubt still exists, the controller should consider the use of an alternative method of separation.

13.8.4.5 Time-based separation

13.8.4.5.1 Ground system flight data records updated by ADS-C reports may be used in the application of appropriate time-based separation standards. Methods of determination may include reference to:

- (a) Estimates at actual waypoints;
- (b) Calculated estimates for positions not contained in the ATS flight plan; or
- (c) Screen-based measurement tools; or

13.8.4.6 Distance-based separation

13.8.4.6.1 ADS-C reports may be used for the application of appropriate longitudinal distance standards. Methods of determination may include:

- (a) The use of automated system tools to measure the displayed positions of two or more aircraft reporting by ADS-C;
- (b) Comparing the displayed position of an ADS-C aircraft with the position of another aircraft determined by an alternative form of surveillance; or
- (c) The use of automated conflict detection tools.

13.8.5 Lateral separation

13.8.5.1 Areas of lateral conflict

13.8.5.1.1 ADS-C reports can be used to determine whether an aircraft is within or beyond an area of lateral conflict. Where lateral conflict calculations are not made by automated conflict detection tools, an ADS-C report observed outside an area of lateral conflict displayed or calculated on the screen is confirmation that the aircraft is outside the area of conflict.

13.9 Air Traffic Clearance Monitoring

ADS-C reports can be used to monitor conformance with air traffic clearances.

13.9.1 Deviations from ATC clearances

13.9.1.1 The pilot of an ADS aircraft observed to deviate significantly from its cleared flight profile shall be advised accordingly. The controller shall also take action as appropriate if such deviation is likely to affect the air traffic service being provided.

13.10 Coordination

13.10.1 Coordinated data inconsistent with ADS displayed data

13.10.1.1 The transferring controller shall advise during coordination if the aircraft is currently at a level or on a route different from that intended for the boundary crossing. When the coordination information relating to the transfer of control is different from the displayed ADS information and the required advice has not been provided, the receiving controller shall confirm the coordinated information with the transferring controller.

13.11 Alerting service

For ADS-equipped aircraft, the provision of the alerting service should be based on the scheduled position reports provided by the periodic reporting contract.

13.11.1 Late or missing ADS-C Reports

13.11.1.1 Whenever an ADS-C report (either a periodic or waypoint report) is not received within a parameter of the expected time, the controller should initiate a demand contract request or establish a new periodic contract with the aircraft

13.12 Position Reporting

13.12.1 Position reporting requirements in ADS airspace

13.12.1A ATSUs should promulgate in the AIP that ADS-C reports fulfill all normal position reporting requirements within the nominated FIR.

13.12.1.1 Publishing reporting requirements

13.12.1.1.1 ATSUs should publish ADS and CPDLC position reporting requirements in the AIP.

13.12.1.2 CPDLC report at FIR entry position

13.12.1.2.1 When an ATSU has nominated the use of ADS-C reporting only within the associated FIR, a CPDLC position report at the FIR entry position is still required to confirm that the ATSU holds the status of Current Data Authority. Following the initial CPDLC report at the boundary, no further CPDLC or voice position reports will be required for operations within the FIR.

13.12.2 Discrepancies between ADS-C and CPDLC estimates

13.12.2A Controllers should be aware that CPDLC and ADS-C estimates received from the same aircraft for the same position may differ as a result of the ADS-C application reporting time to the second and the time reported by CPDLC application either being truncated or rounded to the nearest full minute (depending on aircraft type). The pilot also has the ability to modify the estimate for the next position in the CPDLC position report. Any such modification will not be reflected in the ADS-C report.

13.12.2.1 Actions to be followed when there is an estimate discrepancy

13.12.2.1.1 Where the time difference exceeds 3 minutes, the controller shall query the estimate received in the CPDLC position report and request confirmation of the estimate for the waypoint in question.

CHAPTER 14

CONTROLLER-PILOT DATA LINK COMMUNICATIONS (CPDLC)

Note - Singapore adopts the FANS-1/A procedures and requirements for the use of data link applications contain in the FANS-1/A Operations Manual (FOM), which has been adopted by ICAO for Regional use.

14.1 GENERAL

14.1.1 The CPDLC application provides a means of communication between the controller and pilot, using data link for ATC communication.

14.1.2 This application includes a set of clearance/information/request message elements which correspond to the phraseologies used in the radiotelephony environment.

Note.— See Appendix 5A for the CPDLC message set which list the message elements and their respective message intents/use.

14.1.2.1 The controller shall be provided with the capability to respond to messages, including emergencies, to issue clearances, instructions and advisories, and to request and provide information, as appropriate.

14.1.2.2 The pilot shall be provided with the capability to respond to messages, to request clearances and information, to report information, and to declare or cancel an emergency.

14.1.2.3 The pilot and the controller shall be provided with the capability to exchange messages which do not conform to defined formats (i.e. free text messages).

14.1.3 Ground and airborne systems shall allow for messages to be appropriately displayed, printed when required and stored in a manner that permits timely and convenient retrieval should such action be necessary.

14.1.4 Whenever textual presentation is required, the English language shall be displayed as a minimum.

14.1.5 Message element intent and text and associated procedures are, in general, consistent with Chapter 12 — Phraseologies. It is, however, recognized that the CPDLC message set and the associated procedures differ somewhat from the voice equivalent used because of the differences between the two media; one being direct-speech and the other an exchange of data, the latter of which can be displayed and/or printed.

14.2 Connection Management

14.2.1 Pre-Flight Phase

14.2.1.1 Identifying data link aircraft equipage

14.2.1.1.1 ATS systems use Item 10 (Equipment) of the standard ICAO flight plan to identify an aircraft’s data link capabilities. The operator is responsible for inserting the following items in the ICAO flight plan:

- (a) Item 10 - The letter “J” to indicate data link capability;
- (b) Item 10 - The letter “D” in the Surveillance field to indicate ADS-C capability;
- (c) Item 18 - The letters DAT/ followed by one or more letters as appropriate to indicate the type of data link equipment carried when “J” is entered in Item 10.

Example:

ICAO Item 10:**J**...../**...D**

ICAO Item 18: **REG**/.....**DAT/SV** (for a satellite and VHF data link equipped aircraft)

Letter following DAT/	Type of data link
S	Satellite data link
H	HF data link
V	VHF data link
M	SSR Mode S data link

Table 1: Specifying CPDLC Capability in FPL

14.2.1.2 Registration number

14.2.1.2.1 ATS systems compare the registration number of the aircraft contained in Field 18 (Other Information) of the ICAO flight plan with the registration contained in the AFN logon. The operator is responsible for ensuring that the correct aircraft registration is filed in Field 18 of the ICAO flight plan.

14.3 The AFN Logon

14.3.1 Prerequisite for CPDLC and / or ADS-C connection

14.3.1.1 The AFN logon is a prerequisite for CPDLC and / or ADS-C connection.

14.3.2 The initial AFN logon

14.3.2.1 The initial AFN logon is performed by the pilot manually sending an AFN CONTACT message (FN_CON) containing the 4 character ICAO code of the ANSP.

14.3.3 Constructing the FN_CON message

14.3.3.1 To avoid an automatic rejection of the logon, the pilot shall ensure that the flight identification and registration numbers contained in the FN_CON message are exactly the same as the flight identification and registration numbers filed in the flight plan.

14.4 CPDLC Connection

14.4.1 Purpose of CPDLC connection

14.4.1.1 The purpose of a CPDLC connection is to allow the exchange of CPDLC messages between an aircraft and an ATSU.

14.4.2 Management of CPDLC connections

14.4.2.1 The ATSU shall manage CPDLC connections to ensure that wherever possible the active CPDLC connection is held by the ATSU with responsibility for the flight. Connections should be maintained and terminated to support this requirement. Care must be taken not to issue clearances or instructions to a flight via CPDLC when it is under the control of another sector/ATSU.

14.4.3 CPDLC connection sequence

14.4.3.1 A CPDLC connection attempt can only occur after the AFN logon has been completed. The CPDLC connection is initiated by sending the **CONNECTION REQUEST** message by the ATSU and is established when the **CONNECTION CONFIRM** message is received from the aircraft:

- a) If there is no existing connection, the avionics will accept this connection as the active connection.
- b) If there is an existing connection, the avionics will check that the initiating ATSU has been established as the next data authority. If so, the avionics will accept this connection as the non-active connection.
- c) In all other situations, the avionics will reject the connection request.

14.4.4 Active and inactive CPDLC connections

14.4.4.1 A CPDLC connection established between an aircraft and an ATSU is either active or non-active.

- a) A connection is active when CPDLC messages can be exchanged.
- b) A connection is non-active when CPDLC messages cannot be exchanged.

FANS-1/A aircraft can have two CPDLC connections established, each with a different ATSU. Only one of these connections can be active at any given time. A non-active connection becomes active as soon as the active connection is terminated.

14.5 Next Data Authority Notification

14.5.1 Purpose of the NDA message

14.5.1.1 Definition: The ATSU holding the active connection with the aircraft is known as the ‘Data Authority’. The purpose of the Next Data Authority (NDA) message is to advise the avionics of the next ATSU to become the Data Authority. The sending of the NDA message is the first step in the CPDLC transfer sequence between an aircraft and two ATSUs. The avionics will only accept a CPDLC connection request from the ATSU quoted in the NDA message.

14.5.2 Procedure for the NDA notification

14.5.2A The ATSU with the current active connection notifies the avionics of the Next Data Authority by sending a **NEXT DATA AUTHORITY [icaofacilitydesignation]** message.

14.5.2.1 Sequence of the NDA and FN_CAD messages

14.5.2.1.1 The CPDLC connection sequence can be initiated by automated systems immediately following the AFN logon, the NDA message shall be sent prior to the **AFN CONTACT ADVISORY (FN_CAD)** to avoid a rejection of the connection. The avionics must receive the NDA prior to receiving a connection request message; otherwise the connection request will be rejected.

14.5.2.2 Change of the NDA

14.5.2.2.1 If the next data authority should change after the NDA message has been sent (e.g. an aircraft re-route due to weather), a new NDA message must be sent. This new NDA will supersede the original NDA message in the avionics and will disconnect any inactive connection already established by the unit that had been previously designated as the Next Data Authority. In the following diagram, an inactive connection that is established with ATSU 2 would be dropped when a new NDA designating ATSU 3 is received.

14.5.3 Abnormal cases relating to the NDA notification

14.5.3A If the NDA message (containing the correct Next Data Authority designation) is not received by the avionics before receiving the **CONNECTION**

REQUEST message sent by the subsequent ATSU, the connection request message will be rejected. The pilot has no indication that the **CONNECTION REQUEST** has been rejected.

14.5.3.1 Unsuccessful NDA delivery

14.5.3.1.1 When the NDA delivery has not been successful, the controller's initial action should be to send another NDA message. If this is also unsuccessful, the controller shall instruct the pilot to manually initiate an AFN logon with the subsequent ATSU after termination of the CPDLC connection. An **END SERVICE** message is not required in this case.

The phraseology to be used via CPDLC or voice will be:

Controller	CONTACT [icaounitname] [frequency] Select ATC Com Off then Logon to [ATSU name] <i>(Note: When via CPDLC, this last element will be free text)</i>
Pilot	WILCO

The [ATSU name] is the relevant four character ICAO code

Note: Instructing the pilot to Select ATC Com off will result in loss of CPDLC connectivity. This procedure should only be applied approaching the FIR boundary with the next ATSU.

14.6 End of Service and CPDLC Connection Transfer

14.6.1 Purpose and procedure

14.6.1A Under normal conditions, the current ATSU initiates the CPDLC connection termination sequence by sending an **END SERVICE** uplink message. In response to an **END SERVICE** message:

- (a) The avionics will downlink a **DISCONNECT** message. The avionics will consider the aircraft to be disconnected as soon as the **DISCONNECT** message is sent.
- (b) The current connection will be terminated, activating the non-active connection. The subsequent ATSU will now be able to exchange CPDLC messages with the aircraft.

14.6.1.1 Uplink messages to be closed before the **END SERVICE**

14.6.1.1.1 The controller shall ensure that no open uplink CPDLC messages exist prior to the uplinking of an **END SERVICE** message. In the event that a CPDLC uplink is unanswered, ATC should uplink the free text: CHECK AND RESPOND TO OPEN CPDLC MESSAGES

14.6.1.2 Use of Contact/Monitor Uplink Message

14.6.1.2.1 The purpose of the Contact/Monitor uplink messages (UM#117 to UM#122) is to advise the pilot when (and where) a change to the nominated frequency

is required. When any of the “Monitor” uplink messages are received the pilot shall change to the nominated frequency at the appropriate time. A check call is not required on the frequency. When any of the “Contact” messages are received the pilot shall change to the nominated frequency at the appropriate time and perform a check call on the frequency.

14.6.1.2.2 The sending or receipt of any of the “Contact” uplink messages is not an indication to the pilot that CPDLC use must be terminated or suspended once voice contact is established. If termination or suspension of CPDLC use is intended by the controller when voice contact is established then the requirement must be specifically stated in addition to the CONTACT message element.

14.6.1.3 Synchronizing the CPDLC and voice transfer

14.6.1.3.1 If the CPDLC **MONITOR (OR CONTACT) [icaounitname] [frequency]** message element and the **END SERVICE** message element are to be sent as separate uplink messages, the **END SERVICE** message should be sent as soon as possible after the receipt of the **WILCO** response. This is to ensure synchronization of the CPDLC and the voice communication transfers.

14.6.1.4 Timing of the transfer of communications

14.6.1.4.1 The **MONITOR (OR CONTACT) [icaounitname] [frequency]** and **END SERVICE** message elements should normally be sent after receipt of the last position report before crossing the FIR boundary, but not less than 5 minutes prior to the FIR boundary. This allows the next ATSU’s connection to be active when the aircraft crosses the FIR boundary.

14.6.1.5 Aircraft entering VHF coverage

14.6.1.5.1 For aircraft entering airspace where radar and air-ground VHF are provided, and the aircraft will not cross an FIR boundary, it is not necessary to send an **END SERVICE** message to disconnect CPDLC. In this case, the CPDLC connection will remain active until termination of flight. If subsequent control sectors within the system do not have CPDLC capability, and local instructions do not exist to the contrary, the controller with jurisdiction for CPDLC must ensure that CPDLC clearances or instructions are not issued to the aircraft while it is under the control of another sector.

14.6.2 Abnormal cases at the time of the connection / disconnection

14.6.2.1 There may be unusual situations where a CPDLC connection cannot be automatically terminated (e.g. if the **END SERVICE** message does not trigger the disconnection, or if the **END SERVICE** message is not delivered to the avionics). If the controller is aware that the **END SERVICE** message has been unsuccessful, the controller’s initial action should be to send another **END SERVICE** message. If this is also unsuccessful the pilot will be instructed to terminate the CPDLC connection and logon to the next unit.

The voice phraseology to be used will be:

Controller	Select ATC Com Off then Logon to [ATSU name]
Pilot	Roger

14.7 CPDLC Procedures

14.7.1 Means of Communication

14.7.1.1 General

14.7.1.1.1 Generally, when a CPDLC aircraft is operating within a CPDLC airspace beyond the range of VHF voice communications, then:

- (a) CPDLC will be the primary means of communication, and
- (b) Voice will be used as the backup communication medium (for example VHF, direct HF, third party HF, SATVOICE).

14.7.1.1.2 The response to a CPDLC message should be via CPDLC, and a response to voice should be via voice.

14.7.1.2 Voice communications

14.7.1.2.1 Notification of HF frequencies by CPDLC

14.7.1.2.1.1 The uplink CPDLC frequency transfer message elements can accommodate only one frequency variable. Due to this limitation, the controller will insert the primary HF frequency in these messages. This applies to the following uplinks:

UM#117 CONTACT [icaounitname][frequency]
 UM#118 AT [position] CONTACT [icaounitname][frequency]
 UM#119 AT [time] CONTACT [icaounitname][frequency]
 UM#120 MONITOR [icaounitname][frequency]
 UM#121 AT [position] MONITOR [icaounitname][frequency]
 UM#122 AT [time] MONITOR [icaounitname][frequency]

14.7.1.2.1.2 In areas of poor HF coverage, the controller may consider appending free text nominating a secondary HF frequency. The format of this message is described in Appendix 5B for the CPDLC message set. In the **CONTACT** and **MONITOR** messages RADIO is not an option within the [icaounitname] field. Therefore CENTER will be used to identify a RADIO facility.

14.7.2 CPDLC Capability

14.7.2.1 Notification of CPDLC capability

14.7.2.1.1 An AIP Supplement shall be published to advise the CPDLC capability of an ATS system and its AFN logon address. An aircraft's CPDLC capability shall be notified in the flight plan.

14.7.3 Use of Pre-Formatted and Free Text Messages

14.7.3.1 Preferred use of pre-formatted messages

14.7.3.1.1 Free text messages shall be used only when an appropriate pre-formatted message element does not exist. In particular, the creation of a clearance request and the issuing of a clearance shall be performed by the use of pre-formatted message elements only. The use of pre-formatted message elements allows on board data processing such as the automatic insertion of the clearance information into the Flight Management Computer. It also allows the controller to respond more quickly when the ATS system has the capability to automatically link a pre-formatted request to a pre-formatted response. Additionally, this process minimizes the risk of input errors.

14.7.3.1.2 When a free text message is required, standard ATC phraseology and format shall be used. Non-essential words and phrases should be avoided. Abbreviations should only be included in free text messages when they form part of standard ICAO phraseology, e.g. ETA.

14.7.3.2 Standardized free text messages

14.7.3.2.1 While pre-formatted message elements are required to be used whenever possible, there are occasions where frequent use of free text allows the meaning and appropriate response to be standardized. The Standard Free text message set is shown in Appendix 5B, FANS-1/A CPDLC Standard Free Text Messages.

14.7.4 Exchange of CPDLC messages

14.7.4.1 Message assurance

14.7.4.1.1 The FANS-1/A system does not provide for end-to-end message assurance. Therefore, there can be no guarantee provided by the ground system or the avionics that the message has been delivered to the controller or pilot. However:

- (a) The ATS system will receive a network acknowledgment (MAS Message Assurance) to an uplink message indicating that the message has been delivered to the aircraft's Aircraft Communications Addressing and Reporting System Management Unit, and
- (b) The avionics will receive a network acknowledgment to a downlink message indicating that the message has been delivered to the communication service provider's system.

14.7.4.2 Ambiguous dialogues

14.7.4.2.1 In the case of a controller or pilot having any doubt as to the intent of a message, or if any other ambiguity exists, clarification shall be sought through the use of voice communication.

14.7.4.3 Interruption of a CPDLC dialogue

14.7.4.3.1 If a CPDLC dialogue is interrupted by a system shutdown, the entire dialogue shall be re-commenced by voice communication.

14.7.4.4 Approval of request or clearance / instruction

14.7.4.4.1 Affirmative response to a clearance/instruction

14.7.4.4.1.1 The **WILCO** downlink message indicates that the pilot will comply fully with the clearance/instruction contained in the associated uplink message. The readback of a clearance or instruction issued by CPDLC is not required.

14.7.4.4.2 Affirmative response to a clearance request

14.7.4.4.2.1 The **ROGER** or **AFFIRM** uplinks are not appropriate responses to a clearance request and shall not be used for this purpose. The controller shall only approve a clearance request by uplinking a message containing an actual clearance.

14.7.4.4.3 Conditions relating to a specific clearance

14.7.4.4.3.1 Terms or conditions relating to a specific clearance shall be included in the clearance uplink message. They shall not be sent as a separate message.

14.7.4.4.4 Affirmative response to a negotiation request

14.7.4.4.4.1 **AFFIRM** is an appropriate response to an uplinked negotiation request message that is acceptable (e.g. **CAN YOU ACCEPT [altitude] AT [time]**).

14.7.4.5 Negative response to a downlink request

14.7.4.5.1 Negative response to a clearance request

14.7.4.5.1.1 When a clearance request is denied, the controller shall use the element **UNABLE** (not **NEGATIVE**) in the uplink response. The aircraft's current clearance shall not be re-stated.

14.7.4.5.2 Explanation of negative response

14.7.4.5.2.1 Pre-formatted elements such as **DUE TO TRAFFIC** (or a free text element) should be added to the response message if clarification is considered necessary. Additional elements (including free text elements) in the form of an explanation must be included when responding to a multiple clearance request where some, but not all clearance requests can be granted.

14.7.4.5.3 Offering alternative clearances to downlink requests

14.7.4.5.3.1 If the clearance contained in a downlink request is not available, but an alternative (similar) clearance is available, ATC must not simply respond to the downlink request with the alternative uplink clearance. An UNABLE must be uplinked to close the original clearance request. Depending on workload and traffic, ATC may then uplink an alternative clearance.

Example:

Pilot: REQUEST CLIMB TO F370

Controller: UNABLE. DUE TO TRAFFIC

Controller: CLIMB TO AND MAINTAIN F350. REPORT LEVEL F350

The ATC response in the following example is incorrect and should not be used:

Pilot: REQUEST CLIMB TO F370

Controller: ~~UNABLE. CLIMB TO AND MAINTAIN F350. REPORT LEVEL F350~~

14.7.4.6 Negative response to an uplink request

14.7.4.6.1 **NEGATIVE** is an appropriate response to an uplink negotiation request that is not acceptable (e.g. **CAN YOU ACCEPT [altitude] AT [time]**).

14.7.4.7 Time period between receiving and responding to a message

14.7.4.7A The controller and the pilot shall respond to incoming requests as soon as practicable to avoid duplicate messages entering the system.

14.7.4.7.1 Delays in responding

14.7.4.7.1.1 The controller and the pilot should consider that it takes up to one minute for a message to be received, time for the pilot (or the controller) to take action and respond, and up to one minute for the reply to be received. Nevertheless, they should be aware that extra delays could occur in the transmission of any response to a CPDLC message.

Note. Transmission times for messages may vary depending on the transmission media.

14.7.4.7.2 Delay expected after receiving a “STANDBY” message

14.7.4.7.2.1 The intended use of the uplink STANDBY message element is to provide advice to the flight crew that their requested clearance is being assessed, but is not immediately available. This may be due to traffic, delays in coordination with the next sector or ATS unit etc). It should not be used as a means of simply acknowledging that the downlink request has been received by the ATS ground system.

14.7.4.7.2.2 If the **STANDBY** response is received, a further response can be expected within 10 minutes. The message remains open. If the pilot (or the controller) does not respond within this time, the next message should be in the form of an inquiry, not a duplicated request.

14.7.4.8 Re-sending Messages

14.7.4.8.1 Re-sending of a message when no alert received

14.7.4.8.1.1 When the pilot (or the controller) elects to re-send a message after a reasonable period of time has passed and no error message has been received indicating the non-delivery of the message, the message shall be sent as a query message. Alternatively, voice communication may be used.

Example:

Pilot	REQUEST CLIMB [level]
--------------	-----------------------

Pilot	WHEN CAN I EXPECT [LEVEL]
--------------	---------------------------

14.7.4.8.2 Re-sending of a message when an alert has been received

14.7.4.8.2.1 When an error message indicating the non-delivery of the message has been received at the flight deck or at the controller work station, the pilot (or the controller) may elect to re-send an identical message. Alternatively, voice may be used.

14.7.4.9 Duplicate requests received

14.7.4.9.1 Second identical request after an uplink “STANDBY” message

14.7.4.9.1.1 If a second identical downlink request is sent by the pilot after a reasonable period (more than 10 minutes) has passed since receiving a **STANDBY** response to an earlier request, the controller should respond with **UNABLE REQUEST DEFERRED**. This will close out the second message, inform the pilot that the reply will take longer, and will leave only one open message requiring a response.

14.7.4.9.2 Multiple identical requests

14.7.4.9.2.1 All messages requiring a response must be answered. If the controller (or the pilot) receives a second identical CPDLC request prior to having answered the first, they shall respond to both of the messages to ensure message closure. On rare occasions, the first uplink message may generate an “invalid reference number” error message, in the avionics.

14.7.4.10 Altitude change clearances

14.7.4.10.1 Issuing conditional altitude change clearances

14.7.4.10.1.1 The potential exists for the restriction “**AT**” contained at the beginning of the following conditional clearances to be missed by aircrew and consequently the clearance may be executed prematurely.

UM#21 **AT** [time] **CLIMB TO AND MAINTAIN** [altitude]
 UM#22 **AT** [position] **CLIMB TO AND MAINTAIN** [altitude]
 UM#24 **AT** [time] **DESCEND TO AND MAINTAIN** [altitude]
 UM#25 **AT** [position] **DESCEND TO AND MAINTAIN** [altitude]

14.7.4.10.1.2 Controllers shall precede UM#21, UM#22, UM#24 and UM#25 with UM#19 **MAINTAIN** [altitude] indicating to aircrew to maintain their present altitude until the condition of the clearance is satisfied.

14.7.4.10.2 Level report requirements for climb or descent clearances

14.7.4.10.1.3 If a CPDLC level report is required, controllers shall append UM#129 **REPORT LEVEL** [altitude] to any vertical change clearance to a single altitude so that flight crews have access to the pre-formatted downlink report.

14.7.4.10.1.4 If no **REPORT LEVEL** [altitude] is received, the crew has no requirement to report maintaining the cleared flight level.

Example clearance issued to a flight currently cruising at FL310 requesting climb to FL350 when the climb cannot be executed until the aircraft is at MICKY

MAINTAIN FL310, AT MICKY CLIMB TO AND MAINTAIN FL350, REPORT LEVEL FL350

14.7.4.10.3 Issuing Level Restrictions

Depending on how they are used, certain CPDLC message elements may be used as either:

1. A “stand-alone” clearance; or
2. A level requirement for an interim level, when appended to another CPDLC vertical clearance

This applies to the following message elements:

UM#26 **CLIMB TO REACH** [altitude] **BY** [time]
 UM#27 **CLIMB TO REACH** [altitude] **BY** [position]
 UM#28 **DESCEND TO REACH** [altitude] **BY** [time]
 UM#29 **DESCEND TO REACH** [altitude] **BY** [position]

Example 1:

ATC	CLIMB TO REACH FL390 BY 2200
Meaning	The aircraft is cleared to climb to FL390 and is required to be maintaining FL390 by 2200.

Example 2: The following format may be used to issue a requirement for an interim level. The example shown reflects ICAO phraseology. Some FIRs may choose to reverse the order of the elements shown in the example, so long as both are included.

ATC	CLIMB TO AND MAINTAIN FL390 CLIMB TO REACH FL370 BY 0100
Meaning	The aircraft is cleared to climb to FL390 and is required to reach FL370 (or higher) by 0100.

Note 1. Because of limitations in the FANS-1/A message set, there is no specific message element to issue a requirement for an intermediate level.

Note 2. In the ICAO CPDLC Message set, CLIMB TO [level].REACH [level] BY [time/position] would be used (see Example 2a)

Example 2a:

ATC	CLIMB TO AND MAINTAIN FL390 REACH FL370 BY 0100
Meaning	The aircraft is cleared to climb to FL390 and is required to reach FL370 (or higher) by 0100.

Example 3: Confusion may occur if the vertical clearance and the requirement were sent separately. (This scenario might occur, for example, if the controller decided to add a requirement after issuing the initial clearance):

ATC PILOT	CLIMB TO AND MAINTAIN FL390 WILCO
	Followed by
ATC	CLIMB TO REACH FL370 by 2200

Technically, the second clearance amends the final cleared level of the aircraft (to FL370), which was not the intention of the controller. Because of the confusion inherent in this type of message exchange, this message should not be used in this manner; instead, the entire clearance should be re-stated; *i.e.* CLIMB TO AND MAINTAIN FL390. CLIMB TO REACH FL370 BY 2200.

14.7.4.11 Requesting an aircraft's speed

When the aircraft's Mach number or indicated airspeed is requested, the controller shall use the pre-formatted message element **CONFIRM SPEED**.

14.7.4.12 Advising a wake turbulence offset

In the event of a pilot initiating a wake turbulence offset (up to 2nm either side of track) in RVSM airspace for which the controller is not required to issue a clearance, the pilot shall advise the controller. The following data or voice phraseology shall be used:

Pilot	Wake Dev [direction] <i>Direction L or R (left or right) as appropriate</i>
--------------	--

14.7.5 Multi-Element Requests

14.7.5.1 Avoiding multiple element clearance requests

To avoid potential ambiguity, pilots should, where possible, avoid sending multiple clearance requests in the one downlink message.

14.7.5.2 Responding to multiple element clearance requests

14.7.5.2.1 Multiple clearance requests in one message: All approved

Where a multiple clearance request is received and all clearance request elements can be approved, each clearance request element shall be specifically addressed in the response.

Example:

PILOT	REQUEST CLIMB TO [LEVEL] REQUEST DIRECT TO [POSITION]
CONTROLLER	CLIMB TO AND MAINTAIN [LEVEL] PROCEED DIRECT TO [POSITION]

14.7.5.2.2 Multiple clearance requests in one message: All not approved

If the response to a multi-element message is **UNABLE** then the reply applies to all elements of the original message. The aircraft's current clearance shall not be re-stated.

Example:

PILOT	REQUEST CLIMB TO [LEVEL] REQUEST DIRECT TO [POSITION]
CONTROLLER	UNABLE

14.7.5.2.3 Multiple clearance requests in one message: Some approved / Some not approved

When a multi-element clearance request is received and part of it can be granted and part of it cannot, the uplink shall not contain the single word **UNABLE** and a clearance. If **UNABLE** is used within a clearance message, it must contain a qualifier to remove any ambiguity.

The following examples illustrate **correct** ATC responses.

First correct example:

PILOT	REQUEST CLIMB TO [LEVEL] REQUEST DIRECT TO [POSITION]
CONTROLLER	UNABLE HIGHER ALTITUDE PROCEED DIRECT TO [POSITION]

Second correct example:

PILOT	REQUEST CLIMB TO [LEVEL] REQUEST DIRECT TO [POSITION]
CONTROLLER	UNABLE HIGHER ALTITUDE PROCEED DIRECT TO [POSITION]

The ATC response in the following example is **incorrect and shall never be used**:

PILOT	REQUEST CLIMB TO [LEVEL] REQUEST DIRECT TO [POSITION]
CONTROLLER	UNABLE PROCEED DIRECT TO [POSITION]

14.7.6 Multi-element Uplink Messages

14.7.6.1 Combining multiple elements into a single message

Only uplink elements that are related to the overall message should be combined into a single message. Messages that contain unrelated elements could either cause confusion or result in the crew rejecting the entire message when one of the elements on its own could have been acceptable. The following multi-element uplink is an example of a clearance that can be unambiguously sent as a single message.

WHEN READY
DESCEND TO AND MAINTAIN FL280
REPORT LEVEL FL280

When the elements are not dependent on each other, controllers should send a single element clearance and wait for the response before sending a subsequent instruction.

14.7.6.2 Dependent Clearances

A dependent clearance is a message consisting of more than one clearance element, where the pilot must comply with each of the elements. A rejection of any of the elements, either singly or in combination, renders the entire clearance invalid. The following multi-element uplink is an example of a dependent clearance:

CLIMB TO AND MAINTAIN FL330
AT FL330 PROCEED DIRECT TO TUNTO
REPORT LEVEL FL330.

In this example the aircraft must complete a change of level in order to be issued with an amended route clearance.

Whenever possible, all elements of a dependent clearance should be sent in a single uplink message. Sending the elements as individual messages may compromise safety or separation if the pilot accepts the first uplink of a dependent clearance, complies with the instruction, and then responds UNABLE to the next message when received. By the time that the controller has received the UNABLE response, the aircraft could have begun executing the first instruction of a clearance that is invalid if the pilot cannot comply with the second element.

The response to a multi-element uplink message will either be a WILCO or UNABLE that refers to the entire message. It is not possible for the pilot to respond to individual elements of a multi-element message.

NOTE: Care must be taken in the construction of dependent clearances to ensure that there is no ambiguity present in the message. In the example above, the second element has been carefully chosen to reinforce the requirement instead of using the word THEN followed by the route clearance PROCEED DIRECT TO TUNTO.

The following message is an example of poor message construction as it does not unambiguously convey to the pilot that the climb clearance must be completed prior to commencing the route clearance component. This format SHOULD NOT be used for dependent clearances:

~~CLIMB TO AND MAINTAIN FL330
THEN
PROCEED DIRECT TO TUNTO~~

14.7.7 Message Closure

14.7.7.1 General

Definitions:

- (a) A message requiring a response remains **open** until a referenced response is received.
- (b) A message is **closed** when either a response is not technically required, or after a referenced response other than **STANDBY** or **REQUEST DEFERRED** has been received.

A normal downlink free text message (based on downlink message element DM#67) does not require a response from the controller to close the CPDLC exchange. However, a downlink free text message based on downlink message element DM#68 (Distress attribute) does require a response and the message will remain open until a referenced response is received.

Any uplink message containing only free text requires a **ROGER** response. The message will remain open until a referenced response containing **ROGER** is received.

14.7.7.2 Answering an uplink free text

When the controller sends a message containing only free text, or a free text element combined with elements that do not require a response, the pilot must respond to the free text with a **ROGER** response before responding to the actual contents of the message.

14.7.7.3 Dialogue commenced via CPDLC and continued via voice

If a CPDLC message requiring a closure response is subsequently negotiated by voice, a CPDLC closure response message is still necessary to ensure the proper synchronization of ground and aircraft systems.

14.7.8 Position Reporting

14.7.8.1 General

To harmonize waypoint position reports by either voice or data, the “Position” and “Next Position” shall only contain compulsory reporting points unless requested otherwise by ATC. The “Ensuing Significant Point” may be either the compulsory or non-compulsory reporting point after the “Next Position” (Refer AIREP form MOS-ATS, **Appendix 1**).

14.7.8.2 Downlink of position report

When a CPDLC connection exists in a procedural, non-ADS-C environment, pilots shall ensure that position reporting is conducted via CPDLC. A CPDLC position report shall be sent manually by the pilot whenever an ATC waypoint is passed over, (or passed abeam when offset flight is in progress). ATC expects position reports based on downlink message DM#48 - **POSITION REPORT**.

14.7.8.3 First position report

Pilots shall downlink a CPDLC position report (ATC waypoint) to the next ATSU after the completion of:

- (a) An initial CPDLC connection (when inbound from an area not providing CPDLC services), or during a connection transfer;
- (b) **Either** when the CPDLC connection transfer has been completed; **or** at the associated FIR boundary. This position report is required whether or not there is an ADS-C contract in place. It serves as confirmation that the receiving centre is the Current Data Authority.

14.7.8.3 Updating a waypoint estimate

When it is necessary to update a waypoint ETA, a free text message shall be sent in the form of – Revised ETA [position] [time].

14.7.8.4 Non-receipt of a scheduled position report

If a scheduled position report is not received via CPDLC, the use of voice communication by the controller is not mandatory. The controller may obtain the report by uplinking message UM#147 - **REQUEST POSITION REPORT**.

14.7.9 FANS-1/A CPDLC Message Set and Intent

See Appendix 5A for a complete listing of the message intent for all FANS-1/A CPDLC messages as defined by the OPLINK Panel. Additional comments provided by the ISPACG forum are displayed in *Italics*.

14.7.10 FANS-1/A CPDLC Standard Free Text Message

See Appendix 5B for a complete listing of the standard free text messages and intent for FANS-1/A CPDLC.

14.8 ADS-C Procedures

See Chapter 13 for the provision of ADS-C services.

14.9 Emergency and Non-routine Procedures

14.9.1 Emergency procedures

Although an emergency CPDLC message such as MAYDAY or PAN does not require a closure response, the controller must acknowledge receipt of the message and attempt to determine the nature of the emergency and ascertain any assistance required.

14.9.1.1 Response to an emergency message

When a CPDLC or ADS emergency message is received the controlling authority, in order to better assess the nature of the emergency shall respond as in 14.3.1 above, and may also choose to:

- (a) Increase the PERIODIC contract reporting rate to 5 minutes, or
- (b) Send an ON DEMAND contract request. (Note. This is not required if the periodic reporting rate has been increased – an ADS report will have already been triggered by the avionics when the new periodic contract is received).

Note. Increasing the ADS-C reporting rate also reduces the period between cancellation of the ADS emergency and receipt of the ADS Cancel Emergency downlink.

14.9.1.2 Confirmation of emergency activation

When the ADS emergency mode is activated without a CPDLC emergency message or voice confirmation, and the demand contract report appears to indicate that the aircraft is maintaining normal operations (e.g. the aircraft is not in descent or involved in abrupt maneuvers), the aircraft may be subject to unlawful interference. To check for covert or inadvertent activation of the ADS emergency mode the free text uplink “Confirm ADS” shall be appended to a “Confirm Speed” data or voice request:

CONTROLLER	CONFIRM SPEED CONFIRM ADS
------------	------------------------------

The pilot shall then check the status of the aircraft's ADS Emergency Mode and if the emergency mode has been activated inadvertently, the pilot shall select ADS Emergency Mode to "OFF" and advise ATC by voice or the following CPDLC free text downlink.

PILOT	ADS RESET
-------	-----------

14.9.1.3 Acknowledgement of an emergency message

When an ADS emergency accompanied by a CPDLC emergency message is received, the controller shall immediately acknowledge receipt of the emergency with the pilot by the most appropriate means (voice or CPDLC).

14.9.1.4 CPDLC acknowledgment

A CPDLC acknowledgment shall be in the form of a free text message using the words ROGER MAYDAY or ROGER PAN. This uplink free text message requires a response from the pilot to close the CPDLC exchange. Depending on the nature of the emergency, the free text message may or may not be acknowledged by the pilot.

14.9.1.4.1 Voice contact

When an emergency is acknowledged by CPDLC, controllers may also attempt to make voice contact with the aircraft.

14.9.1.5 Retaining the active connection

If CPDLC is the best (or only) communications medium available between the aircraft and any ATSU, the ATSU with the active connection should maintain that connection until better assistance can be provided by another means. In this case, transfer of the connection should not occur to another unit, and any automatic transfer capability should be disabled, if possible, in order to improve the chances of the CPDLC connection being retained.

14.9.1.5.1 Communications responsibility

It is recognized that if a transfer of the CPDLC connection does not occur, then the responsibility for maintaining communications with the aircraft is retained by the current ATSU.

14.9.1.5.2 Executive control responsibility

In accordance with established procedures, the responsibility for the control of the flight rests with the ATSU within whose airspace the aircraft is operating. If the pilot takes action contrary to a clearance that has already been coordinated with another

sector or ATSU and further coordination is not possible in the time available, then this action would be performed under the pilot's emergency authority.

14.9.1.6 Normal emergency procedures

After receipt of the emergency message is acknowledged, normal emergency response procedures shall be followed.

14.9.1.7 Coordination in the case of emergency

When the ADS emergency mode is observed by an ATSU that is not in control of the aircraft, that ATSU shall coordinate with the controlling authority to ensure that the emergency report has been received. Adjacent ATSUs shall not increase the reporting rate of the periodic contract.

14.9.2 Data Link Connection Failures

14.9.2.1 Detected by the controller

When the controller recognizes a failure of the data link connection, the controller shall instruct the pilot to terminate the connection, by selecting ATC Com Off, and then initiate another ATS Facilities Notification (AFN) logon. Once the AFN logon is established, the ATS system should send a **CONNECTION REQUEST** message to re-establish the connection.

The voice phraseology to be used shall be:

CONTROLLER	DATA LINK FAILED. SELECT ATC COM OFF THEN LOGON TO [ATSU NAME]
PILOT	ROGER

The [ATS Unit name] is the 4 character ICAO code.

14.9.2.2 Detected by the airborne system

When the avionics/pilot recognizes a failure of the data link connection, the pilot shall terminate the connection by selecting ATC Com Off and then initiate a new AFN logon (FN_CON) to the current controlling authority.

14.9.2.3 Inability to establish the data link connection

In situations where a data link connection cannot be established successfully, the ATS system should indicate to the controller that no connection has been established.

14.9.3 Data link System Shutdowns

14.9.3.1 Unexpected data link shutdowns

In the event of an unexpected data link shutdown, the relevant ATS unit (ATSU) shall inform:

- (a) currently connected FANS-1/A equipped aircraft via voice;

The voice phraseology to be used shall be:

CONTROLLER	DATA LINK FAILED. SELECT ATC COM OFF. CONTINUE ON VOICE
PILOT	ROGER

- (b) The adjacent ATSUs by direct coordination;
- (c) All relevant parties via the publication of a NOTAM, if appropriate.

Pilots shall terminate the data link connection and use voice until informed by the ATSU that the data link system has resumed normal operations.

14.9.3.2 Planned data link shutdowns

When a planned data link system shutdown of the communications network, or of the ATS system, occurs a NOTAM shall be published to inform all affected parties of the shutdown period. During that time period, voice shall be used.

The following voice or data phraseology shall be used to advise airborne aircraft prior to the commencement of the shutdown.

CONTROLLER	DATA LINK WILL BE SHUTDOWN. SELECT ATC COM OFF. CONTINUE ON VOICE <i>(The pilot shall select ATC Com Off when the message is received)</i>
PILOT	ROGER

14.9.3.3 Resumption of data link operations

The following voice phraseology shall be used to advise pilots that the data link system has resumed operations.

CONTROLLER	DATA LINK OPERATIONAL LOGON ON TO [ATSU name]
PILOT	LOGON [ATSU name]

14.9.3.4 Data link component shutdown

Some ATSU's are not equipped with both CPDLC and ADS-C and consequently may experience shutdown of a single component of the data link system (i.e. CPDLC or ADS-C). For those ATSU's that have both CPDLC and ADS-C it is not likely that just one component will shutdown, however it is possible.

ATSU's experiencing a shutdown of either CPDLC or ADS-C shall follow the procedures above for data link shutdowns as appropriate.

14.9.3.4.1 ADS only failure

When a shutdown of the ground component of the ADS system occurs, the ATSU affected shall inform all other affected parties of the shutdown and likely period. During that time period, position reports (via CPDLC if available, or via voice) will be required.

If a CPDLC service is still available, a CPDLC free text message shall be sent to the pilot notifying reporting requirements. The following phraseology shall be used:

CONTROLLER	ADS SHUTDOWN REVERT TO ATC DATA LINK POSITION REPORTS
PILOT	ROGER

14.9.3.4.2 Loss of ADS-C

If it is not possible to establish ADS-C contracts, or if ADS-C reporting from an aircraft ceases unexpectedly, it is possible that the pilot may have inadvertently selected ADS-C off. If CPDLC is still available, a CPDLC free text message shall be sent to the pilot, using the following phraseology.

CONTROLLER	CONFIRM ADS ARMED
PILOT	ROGER

Note. If ADS had been turned off, re-arming it will not re-initiate previous ADS-C contracts. New ADS-C contracts will need to be uplinked by the ground station.

14.9.3.5 Network and satellite data service outages

In the event of a planned or unexpected network or satellite data service outage (e.g., Ground Earth Station failure), the communications service provider shall make timely notification of the situation to all ATSU's within the affected area.

- (a) All currently connected FANS equipped aircraft via voice, using the following voice phraseology:

CONTROLLER	DATA LINK FAILED SELECT ATC COM OFF. CONTINUE ON VOICE
PILOT	ROGER

- (b) The adjacent ATSUs by direct coordination,
(c) All relevant parties via the publication of a NOTAM, if appropriate.

Pilots shall terminate CPDLC connections with the ATSU and use voice communications until informed by the ATSU that the system is again fully functional.

14.9.3.6 Unexpected avionics system shutdown

In the event of an unexpected avionics data link shutdown, pilots shall inform the ATSU of the situation using voice.

The voice phraseology to be used shall be:

PILOT	DATA LINK FAILED SELECTING ATC COM OFF. CONTINUING ON VOICE
CONTROLLER	ROGER. CONTINUE ON VOICE

Pilots shall continue to use voice until the functionality of the avionics can be re-established.

14.9.4 Total Communications Failure

The procedures covering complete communications failure (CPDLC and voice) shall be in accordance with procedures in the MOS-ATS.

14.9.5 Using CPDLC to relay messages

When an ATSU and an aircraft cannot communicate, and an intermediary data link aircraft is used for relaying messages, the following shall apply:

- (a) Only a free text message shall be used;
(b) The first word in the message shall be “RELAY”.

Note: The use of pre-formatted messages is prohibited because the intermediary aircraft's Flight Management System could be unintentionally armed.

Example

CONTROLLER (all Free text)	RELAY. [ATSU] CLEARS [call-sign] CLIMB TO AND MAINTAIN F340
PILOT (all Free text)	RELAY FROM [call-sign] CLIMBING F340

14.9.6 Weather deviation procedures

14.9.6.1 Multiple weather deviations

The distance off track contained in a weather deviation request or clearance is measured reference the nominally cleared track of the aircraft. Subsequent weather deviations or route clearances supersede any previous weather deviation clearance.

Example

Aircraft requests and is cleared to operate 20NM left of track

PILOT	REQUEST WEATHER DEVIATION UP TO LEFT 20NM
CONTROLLER	CLEARED TO DEVIATE UP TO 20NM LEFT OF TRACK
PILOT	WILCO

If the aircraft then requires a clearance to operate a further 30NM left of track, the clearance request shall be based on the nominal route rather in relation to the current weather deviation clearance.

PILOT	REQUEST WEATHER DEVIATION UP TO 50NM LEFT OF TRACK
CONTROLLER	CLEARED TO DEVIATE UP TO 50NM LEFT OF TRACK
PILOT	WILCO

If the aircraft then requires a clearance to operate 30NM **right** of track

PILOT	REQUEST WEATHER DEVIATION UP TO 30NM RIGHT OF TRACK
CONTROLLER	CLEARED TO DEVIATE UP TO 30NM RIGHT OF TRACK
PILOT	WILCO

Whilst the aircraft navigates from one side of track to the other in order to comply with the above clearance, it is the responsibility of ATC to ensure that the appropriate separation standards are being applied. The aircraft should expeditiously navigate so as to establish itself to the right side of track.

14.9.6.2 Deviations either side of track

There are a number of valid formats for the CPDLC [direction] variable. A number of aircraft types, however, can only request directions left or right in weather deviation requests. If one of these aircraft requires a deviation to the left and right of track, the following procedure should be used:

- (a) Construct a preformatted weather deviation downlink request for a deviation on one side of track, and
- (b) Append free text describing the distance to the other side of track.

PILOT	REQUEST WEATHER DEVIATION UP TO LEFT 20NM (free text) AND 20NM RIGHT
CONTROLLER	CLEARED TO DEVIATE UP TO 20NM EITHER SIDE OF ROUTE
PILOT	WILCO

14.9.6.3 Reporting back on track

A weather deviation clearance remains in effect until either:

- (a) A “back on route” report is received, or
- (b) The aircraft reaches a subsequent waypoint to which it has been cleared when clear of weather.

CHAPTER 15

PROCEDURES RELATED TO EMERGENCIES, COMMUNICATION FAILURE AND CONTINGENCIES

15.1 EMERGENCY PROCEDURES

15.1.1 General

15.1.1.1 The various circumstances surrounding each emergency situation preclude the establishment of exact detailed procedures to be followed. The procedures outlined herein are intended as a general guide to air traffic services personnel. Air traffic control units shall maintain full and complete coordination, and personnel shall use their best judgement in handling emergency situations.

Note 1.— Additional procedures to be applied in relation to emergencies and contingencies while using an ATS surveillance system are contained in Chapter 8, 8.8.1.

Note 2.— If the pilot of an aircraft encountering a state of emergency has previously been directed by ATC to select a specific transponder code and/or a specific ADS-B emergency mode, that code and/or mode will normally be maintained unless, in special circumstances, the pilot has decided or has been advised otherwise. Where ATC has not requested a code or emergency mode to be set, the pilot will set the transponder to Mode A Code 7700 and/or the appropriate ADS-B emergency mode.

Note 3. — Some aircraft equipped with first generation ADS-B avionics have the capability to transmit a general emergency alert only, regardless of the code selected by the pilot.

Note 4. — Some aircraft equipped with first generation ADS-B avionics do not have the capability of squawking IDENT while the emergency and/or urgency mode is selected.

15.1.1.2 When an emergency is declared by an aircraft, the ATS unit should take appropriate and relevant action as follows:

- a) unless clearly stated by the flight crew or otherwise known, take all necessary steps to ascertain aircraft identification and type, the type of emergency, the intentions of the flight crew as well as the position and level of the aircraft;
- b) decide upon the most appropriate type of assistance which can be rendered;
- c) enlist the aid of any other ATS unit or other services which may be able to provide assistance to the aircraft;
- d) provide the flight crew with any information requested as well as any additional relevant information, such as details on suitable aerodromes, minimum safe altitudes, weather information;

e) obtain from the operator or the flight crew such of the following information as may be relevant: number of persons on board, amount of fuel remaining, possible presence of hazardous materials and the nature thereof; and

f) notify the appropriate ATS units and authorities as specified in local instructions.

15.1.1.3 Changes of radio frequency and SSR code should be avoided if possible and should normally be made only when or if an improved service can be provided to the aircraft concerned. Manoeuvring instructions to an aircraft experiencing engine failure should be limited to a minimum. When appropriate, other aircraft operating in the vicinity of the aircraft in emergency should be advised of the circumstances.

Note.— Requests to the flight crew for the information contained in 15.1.1.2 e) will be made only if the information is not available from the operator or from other sources and will be limited to essential information.

15.1.2 Priority

An aircraft known or believed to be in a state of emergency, including being subjected to unlawful interference, shall be given priority over other aircraft.

15.1.3 Unlawful interference and aircraft bomb threat

15.1.3.1 Air traffic services personnel shall be prepared to recognize any indication of the occurrence of unlawful interference with an aircraft.

15.1.3.2 Whenever unlawful interference with an aircraft is suspected, and where automatic distinct display of SSR Mode A Code 7500 and Code 7700 is not provided, the controller shall attempt to verify any suspicion by setting the SSR decoder to Mode A Code 7500 and thereafter to Code 7700.

Note.— An aircraft equipped with an SSR transponder is expected to operate the transponder on Mode A Code 7500 to indicate specifically that it is the subject of unlawful interference. The aircraft may operate the transponder on Mode A Code 7700, to indicate that it is threatened by grave and imminent danger and requires immediate assistance. An aircraft equipped with other surveillance system transmitters, including ADS-B and ADS-C, might send the emergency and/or urgency signal by all of the available means.

15.1.3.3 Whenever unlawful interference with an aircraft is known or suspected or a bomb threat warning has been received, ATS units shall promptly attend to requests by, or to anticipated needs of, the aircraft, including requests for relevant information relating to air navigation facilities, procedures and services along the route of flight and at any aerodrome of intended landing, and shall take such action as is necessary to expedite the conduct of all phases of the flight.

15.1.3.3.1 ATS units shall also:

a) transmit, and continue to transmit, information pertinent to the safe conduct of the flight, without expecting a reply from the aircraft;

b) monitor and plot the progress of the flight with the means available, and coordinate transfer of control with adjacent ATS units without requiring transmissions or other responses from the aircraft, unless communication with the aircraft remains normal;

c) inform, and continue to keep informed, appropriate ATS units, including those in adjacent FIRs, which may be concerned with the progress of the flight;

Note.— In applying this provision, account shall be taken of all the factors which may affect the progress of the flight, including fuel endurance and the possibility of sudden changes in route and destination. The objective is to provide, as far in advance as is practicable in the circumstances, each ATS unit with appropriate information as to the expected or possible penetration of the aircraft into its area of responsibility.

d) notify:

1) the operator or its designated representative;

2) the appropriate rescue coordination centre in accordance with appropriate alerting procedures;

3) other appropriate State authority;

Note.— It is assumed that the designated security authority and/or the operator will in turn notify other parties concerned in accordance with pre-established procedures.

e) relay appropriate messages, relating to the circumstances associated with the unlawful interference, between the aircraft and designated authorities.

Note.— These messages include, but are not limited to: initial messages declaring an incident; update messages on an existing incident; messages containing decisions made by appropriate decision makers; messages on transfer of responsibility; messages on acceptance of responsibility; messages indicating that an entity is no longer involved in an incident; and messages closing an incident.

15.1.3.4 The following additional procedures shall apply if a threat is received indicating that a bomb or other explosive device has been placed on board a known aircraft. The ATS unit receiving the threat information shall:

a) if in direct communication with the aircraft, advise the flight crew without delay of the threat and the circumstances surrounding the threat; or

b) if not in direct communication with the aircraft, advise the flight crew by the most expeditious means through other ATS units or other channels.

15.1.3.5 The ATS unit in communication with the aircraft shall ascertain the intentions of the flight crew and report those intentions to other ATS units which may be concerned with the flight.

15.1.3.6 The aircraft shall be handled in the most expeditious manner while ensuring, to the extent possible, the safety of other aircraft and that personnel and ground installations are not put at risk.

15.1.3.7 Aircraft in flight shall be given re-clearance to a requested new destination without delay. Any request by the flight crew to climb or descend for the purpose of equalizing or reducing the differential between the outside air pressure and the cabin air pressure shall be approved as soon as possible.

15.1.3.8 An aircraft on the ground should be advised to remain as far away from other aircraft and installations as possible and, if appropriate, to vacate the runway. The aircraft should be instructed to taxi to a designated or isolated parking area in accordance with local instructions. Should the flight crew disembark passengers and crew immediately, other aircraft, vehicles and personnel should be kept at a safe distance from the threatened aircraft.

15.1.3.9 ATS units shall not provide any advice or suggestions concerning action to be taken by the flight crew in relation to an explosive device.

15.1.3.10 An aircraft known or believed to be the subject of unlawful interference or which for other reasons needs isolation from normal aerodrome activities shall be cleared to the designated isolated parking position. Where such an isolated parking position has not been designated, or if the designated position is not available, the aircraft shall be cleared to a position within the area or areas selected by prior agreement with the aerodrome authority. The taxi clearance shall specify the taxi route to be followed to the parking position. This route shall be selected with a view to minimizing any security risks to the public, other aircraft and installations at the aerodrome.

Note.— See ICAO Annex 14, Volume I, Chapter 3.

15.1.4 Emergency descent

15.1.4.1 GENERAL

Upon receipt of advice that an aircraft is making an emergency descent through other traffic, all possible action shall be taken immediately to safeguard all aircraft concerned. When deemed necessary, air traffic control units shall immediately broadcast by means of the appropriate radio aids, or if not possible, request the appropriate communications stations immediately to broadcast an emergency message.

15.1.4.2 ACTION BY THE PILOT-IN-COMMAND

It is expected that aircraft receiving such a broadcast will clear the specified areas and stand by on the appropriate radio frequency for further clearances from the air traffic control unit.

15.1.4.3 SUBSEQUENT ACTION BY THE AIR TRAFFIC CONTROL UNIT

Immediately after such an emergency broadcast has been made the ACC, the approach control unit, or the aerodrome control tower concerned shall forward further clearances to all aircraft involved as to additional procedures to be followed during and subsequent to the emergency descent. The ATS unit concerned shall additionally inform any other ATS units and control sectors which may be affected.

15.2 SPECIAL PROCEDURES FOR IN-FLIGHT CONTINGENCIES IN OCEANIC AIRSPACE

15.2.1 Introduction

15.2.1.1 Although all possible contingencies cannot be covered, the procedures in 15.2.2 and 15.2.3 provide for the more frequent cases such as:

- a) inability to comply with assigned clearance due to meteorological conditions, aircraft performance or pressurization failure;
- b) en-route diversion across the prevailing traffic flow; and
- c) loss of, or significant reduction in, the required navigation capability when operating in an airspace where the navigation performance accuracy is a prerequisite to the safe conduct of flight operations.

15.2.1.2 With regard to 15.2.1.1 a) and b), the procedures are applicable primarily when descent and/or turnback or diversion is required. The pilot shall take actions as necessary to ensure the safety of the aircraft and the pilot's judgment shall determine the sequence of actions to be taken, having regard to the prevailing circumstances. Air traffic control shall render all possible assistance.

15.2.2 General procedures

15.2.2.1 If an aircraft is unable to continue the flight in accordance with its ATC clearance, and/or an aircraft is unable to maintain the navigation performance accuracy specified for the airspace, a revised clearance shall be obtained, whenever possible, prior to initiating any action.

15.2.2.2 The radiotelephony distress signal (MAYDAY) or urgency signal (PAN PAN) preferably spoken three times shall be used as appropriate. Subsequent ATC action with respect to that aircraft shall be based on the intentions of the pilot and the overall air traffic situation.

15.2.2.3 If prior clearance cannot be obtained until a revised clearance is received, the following contingency procedures should be employed and the pilot shall advise air traffic control as soon as practicable, reminding of the type of aircraft involved and the nature of the problem. In general terms, the aircraft should flown at a flight level and on an offset track where other aircraft are least likely to be encountered. Specifically, the pilot shall:

- a) leave the assigned route or track by initially turning at least 45 degrees to the right or to the left, in order to acquire a same or opposite direction track offset 15 NM from the assigned track centerline. When possible, the direction of the turn should be determined by the position of the aircraft relative to any organized route or track system. Other factors which may affect the direction of the turn are:

- 1) the direction to an alternate airport;
 - 2) terrain clearance;
 - 3) any strategic lateral offset being flown; and
 - 4) the flight levels allocated on adjacent routes or tracks;
- b) having initiated the turn,
- 1) if unable to maintain the assigned flight level, initially minimize the rate of descent to the extent that is operationally feasible (pilots should take into account the possibility that aircraft below on the same track may be flying a 1 or 2 NM strategic lateral offset procedures (SLOP)) and select a final altitude which differs from those normally used by 500 ft if at or below FL 410, or by 1 000 ft if above FL 410; or
 - 2) if able to maintain the assigned flight level, once the aircraft has deviated 10 NM from the assigned track centreline, climb or descend to select a flight level which differs from those normally used by 500 ft, if at or below FL 410, or by 1 000 ft if above FL 410;
- c) establish communications with and alert nearby aircraft by broadcasting, at suitable intervals on 121.5 MHz (or, as a backup, on the inter-pilot air-to-air frequency 123.45 MHz) and where appropriate on the frequency in use: aircraft identification, flight level, position (including the ATS route designator or the track code, as appropriate) and intentions;
- d) maintain a watch for conflicting traffic both visually and by reference to ACAS (if equipped);
- e) turn on all aircraft exterior lights (commensurate with appropriate operating limitations); and
- f) keep the SSR transponder on at all times.

15.2.2.3.1 When leaving the assigned track:

- a) if the intention is to acquire a same direction offset track, the pilot should consider limiting the turn to a 45 degree heading change, in order not to overshoot the offset contingency track; or
- b) if the intention is to acquire and maintain an opposite direction offset track, then:
 - 1) operational limitations on bank angles at cruising altitudes will normally result in

overshooting the track to be acquired. In such cases a continuous turn should be extended beyond 180 degrees heading change, in order to re-intercept the offset contingency track as soon as operationally feasible; and

2) furthermore, if executing such a turnback in a 30 NM lateral separation route structure, extreme caution pertaining to opposite direction traffic on adjacent routes must be exercised and any climb or descent, as specified in 15.2.2.3 b) 2), should be completed preferably before approaching within 10 NM of any adjacent ATS route.

15.2.2.4 EXTENDED RANGE OPERATIONS BY AEROPLANES WITH TWO-TURBINE POWER-UNITS (ETOPS)

If the contingency procedures are employed by a twin-engine aircraft as a result of an engine shutdown or failure of an ETOPS critical system, the pilot should advise ATC as soon as practicable of the situation, reminding ATC of the type of aircraft involved, and request expeditious handling.

15.2.3 Weather deviation procedures

15.2.3.1 GENERAL

Note.— The following procedures are intended for deviations around adverse meteorological conditions.

15.2.3.1.1 When the pilot initiates communications with ATC, a rapid response may be obtained by stating “WEATHER DEVIATION REQUIRED” to indicate that priority is desired on the frequency and for ATC response. When necessary, the pilot should initiate the communications using the urgency call “PAN PAN” (preferably spoken three times).

15.2.3.1.2 The pilot shall inform ATC when weather deviation is no longer required, or when a weather deviation has been completed and the aircraft has returned to its cleared route.

15.2.3.2 ACTIONS TO BE TAKEN WHEN CONTROLLER-PILOT COMMUNICATIONS ARE ESTABLISHED

15.2.3.2.1 The pilot should notify ATC and request clearance to deviate from track, advising, when possible, the extent of the deviation expected.

15.2.3.2.2 ATC should take one of the following actions:

a) when appropriate separation can be applied, issue clearance to deviate from track; or

b) if there is conflicting traffic and ATC is unable to establish appropriate separation, ATC shall:

1) advise the pilot of inability to issue clearance for the requested deviation;

- 2) advise the pilot of conflicting traffic; and
- 3) request the pilot's intentions.

15.2.3.2.3 The pilot should take the following actions:

- a) comply with the ATC clearance issued; or
- b) advise ATC of intentions and execute the procedures detailed in 15.2.3.3.

15.2.3.3 ACTIONS TO BE TAKEN IF A REVISED ATC CLEARANCE CANNOT BE OBTAINED

Note.— The provisions of this section apply to situations where a pilot needs to exercise the authority of a pilot-in-command under the provisions of ICAO Annex 2, 2.3.1.

If the aircraft is required to deviate from track to avoid adverse meteorological conditions and prior clearance cannot be obtained, an ATC clearance shall be obtained at the earliest possible time. Until an ATC clearance is received, the pilot shall take the following actions:

- a) if possible, deviate away from an organized track or route system;
- b) establish communications with and alert nearby aircraft by broadcasting, at suitable intervals: aircraft identification, flight level, position (including ATS route designator or the track code) and intentions, on the frequency in use and on 121.5 MHz (or, as a backup, on the inter-pilot air-to-air frequency 123.45 MHz);
- c) watch for conflicting traffic both visually and by reference to ACAS (if equipped);

Note.— If, as a result of actions taken under the provisions of 15.2.3.3.1 b) and c), the pilot determines that there is another aircraft at or near the same flight level with which a conflict may occur, then the pilot is expected to adjust the path of the aircraft, as necessary, to avoid conflict.

- d) turn on all aircraft exterior lights (commensurate with appropriate operating limitations);
- e) for deviations of less than 19 km (10 NM) remain at a level assigned by ATC;
- f) for deviations greater than 19 km (10 NM), when the aircraft is approximately 19 km (10 NM) from track, initiate a level change in accordance with Table 15-1;
- g) when returning to track, be at its assigned flight level when the aircraft is within approximately 19 km (10 NM) of the centre line; and
- h) if contact was not established prior to deviating, continue to attempt to contact ATC to obtain a clearance. If contact was established, continue to keep ATC advised of intentions and obtain essential traffic information.

Table 15-1

<i>Route centre line track</i>	<i>Deviations > 19 km (10 NM)</i>	<i>Level change</i>
EAST 000° – 179° magnetic	LEFT RIGHT	DESCEND 90 m (300 ft) CLIMB 90 m (300 ft) WEST
WEST 180° – 359° magnetic	LEFT RIGHT	CLIMB 90 m (300 ft) DESCEND 90 m (300 ft)

15.2.4 Procedures for strategic lateral offsets in oceanic and remote continental airspace

Note 1.— ICAO Annex 2, 3.6.2.1.1, requires authorization for the application of strategic lateral offsets from the ANSP responsible for the airspace concerned.

Note 2.— The following incorporates lateral offset procedures for both the mitigation of the increasing lateral overlap probability due to increased navigation accuracy, and wake turbulence encounters.

Note 3.— The use of highly accurate navigation systems (such as the global navigation satellite system (GNSS)) by an increasing proportion of the aircraft population has had the effect of reducing the magnitude of lateral deviations from the route centre line and, consequently, increasing the probability of a collision, should a loss of vertical separation between aircraft on the same route occur.

15.2.4.1 The following shall be taken into account by the ANSP when authorizing the use of strategic lateral offsets in a particular airspace:

- a) strategic lateral offsets shall only be authorized in en-route oceanic or remote continental airspace. Where part of the airspace in question is provided with an ATS surveillance service, transiting aircraft should normally be allowed to initiate or continue offset tracking;
- b) strategic lateral offsets may be authorized for the following types of routes (including where routes or route systems intersect):
 - 1) uni-directional and bi-directional routes; and
 - 2) parallel route systems where the spacing between route centre lines is not less than 55.5 km (30 NM);
- c) in some instances it may be necessary to impose restrictions on the use of strategic lateral offsets, e.g. where their application may be inappropriate for reasons related to obstacle clearance;
- d) strategic lateral offset procedures should be implemented on a regional basis after coordination between all States involved;

e) the routes or airspace where application of strategic lateral offsets is authorized, and the procedures to be followed by pilots, shall be promulgated in aeronautical information publications (AIPs); and

f) air traffic controllers shall be made aware of the airspace within which strategic lateral offsets are authorized.

15.2.4.1.1 The decision to apply a strategic lateral offset shall be the responsibility of the flight crew. The flight crew shall only apply strategic lateral offsets in airspace where such offsets have been authorized by the appropriate ATS unit and when the aircraft is equipped with automatic offset tracking capability.

15.2.4.1.2 The strategic lateral offset shall be established at a distance of 1 NM or 2 NM to the right of the centre line relative to the direction of flight.

Note 1.— Pilots may contact other aircraft on the inter-pilot air-to-air frequency 123.45 MHz to coordinate offsets.

Note 2.— The strategic lateral offset procedure has been designed to include offsets to mitigate the effects of wake turbulence of preceding aircraft. If wake turbulence needs to be avoided, one of the three available options (centre line, 1 NM or 2 NM right offset) may be used.

Note 3.— Pilots are not required to inform ATC that a strategic lateral offset is being applied.

15.3 AIR-GROUND COMMUNICATIONS FAILURE

Note 1.— Procedures to be applied in relation to an aircraft experiencing air-ground communication failure when providing ATS surveillance services are contained in Chapter 8, Section 8.8.3.

Note 2.— An aircraft equipped with an SSR transponder is expected to operate the transponder on Mode A Code 7600 to indicate that it has experienced air-ground communication failure. An aircraft equipped with other surveillance system transmitters, including ADS-B and ADS-C, might indicate the loss of air-ground communication by all of the available means.

Note 3.— Some aircraft equipped with first generation ADS-B avionics have the capability to transmit a general emergency alert only, regardless of the code selected by the pilot.

Note 4.— See also Chapter 6, 6.3.2.5, concerning departure clearances containing no geographical or time limit for an initial level and procedures to be applied in relation to an aircraft experiencing air-ground communication failure under such circumstances.

Note 5.— See also Chapter 5, 5.4.2.6.3.2, for additional requirements applying to communication failure during the application of the 50 NM longitudinal RNAV/RNP 10 separation minimum.

15.3.1 Action by air traffic control units when unable to maintain two-way communication with an aircraft operating in a control area or control zone shall be as outlined in the paragraphs which follow.

15.3.2 As soon as it is known that two-way communication has failed, action shall be taken to ascertain whether the aircraft is able to receive transmissions from the air traffic control unit by requesting it to execute a specified manoeuvre which can be

observed by an ATS surveillance system or to transmit, if possible, a specified signal in order to indicate acknowledgement.

Note. — *Some aircraft equipped with first generation ADS-B avionics do not have the capability of squawking IDENT while the emergency and/or urgency mode is selected.*

15.3.3 If the aircraft fails to indicate that it is able to receive and acknowledge transmissions, separation shall be maintained between the aircraft having the communication failure and other aircraft, based on the assumption that the aircraft will:

a) if in visual meteorological conditions:

- 1) continue to fly in visual meteorological conditions;
- 2) land at the nearest suitable aerodrome; and
- 3) report its arrival by the most expeditious means to the appropriate air traffic control unit; or

b) if in instrument meteorological conditions or when conditions are such that it does not appear likely that the pilot will complete the flight in accordance with a):

- 1) in airspace where procedural separation is being applied, maintain the last assigned speed and level, or minimum flight altitude if higher, for a period of 20 minutes following the aircraft's failure to report its position over a compulsory reporting point and thereafter adjust level and speed in accordance with the filed flight plan; or
- 2) in airspace where an ATS surveillance system is used in the provision of air traffic control, maintain the last assigned speed and level, or minimum flight altitude if higher, for a period of 7 minutes following:

i) the time the last assigned level or minimum flight altitude is reached;
or

ii) the time the transponder is set to Code 7600 or the ADS-B transmitter is set to indicate the loss of air-ground communications; or

iii) the aircraft's failure to report its position over a compulsory reporting point;

whichever is later and thereafter adjust level and speed in accordance with the filed flight plan;

- 3) when being vectored or having been directed by ATC to proceed offset using RNAV without a specified limit, proceed in the most direct manner possible to rejoin the current flight plan route no later than the next significant point, taking into consideration the applicable minimum flight altitude;

4) proceed according to the current flight plan route to the appropriate designated navigation aid or fix serving the destination aerodrome and, when required to ensure compliance with 5), hold over this aid or fix until commencement of descent;

5) commence descent from the navigation aid or fix specified in 4) at, or as close as possible to, the expected approach time last received and acknowledged; or, if no expected approach time has been received and acknowledged, at, or as close as possible to, the estimated time of arrival resulting from the current flight plan;

6) complete a normal instrument approach procedure as specified for the designated navigation aid or fix; and

7) land, if possible, within 30 minutes after the estimated time of arrival specified in 5) or the last acknowledged expected approach time, whichever is later.

Note 1.— Provisions related to minimum levels are contained in ICAO Annex 2, 5.1.2.

Note 2.— As evidenced by the meteorological conditions prescribed therein, 15.3.3 a) relates to all controlled flights, whereas 15.3.3 b) relates only to IFR flights.

Note 3.— See also 8.6.5.1 b) concerning the requirement for the flight crew to be informed of what a vector is to accomplish and the limit of the vector.

15.3.4 Action taken to ensure suitable separation shall cease to be based on the assumption stated in 15.3.3 when:

a) it is determined that the aircraft is following a procedure differing from that in 15.3.3; or

b) through the use of electronic or other aids, air traffic control units determine that action differing from that required by 15.3.3 may be taken without impairing safety; or

c) positive information is received that the aircraft has landed.

15.3.5 As soon as it is known that two-way communication has failed, appropriate information describing the action taken by the air traffic control unit, or instructions justified by any emergency situation, shall be transmitted blind for the attention of the aircraft concerned, on the frequencies available on which the aircraft is believed to be listening, including the voice frequencies of available radio navigation or approach aids. Information shall also be given concerning:

a) meteorological conditions favourable to a cloud-breaking procedure in areas where congested traffic may be avoided; and

b) meteorological conditions at suitable aerodromes.

15.3.6 Pertinent information shall be given to other aircraft in the vicinity of the presumed position of the aircraft experiencing the failure.

15.3.7 As soon as it is known that an aircraft which is operating in its area of responsibility is experiencing an apparent radiocommunication failure, an air traffic services unit shall forward information concerning the radiocommunication failure to all air traffic services units concerned along the route of flight. The ACC in whose area the destination aerodrome is located shall take steps to obtain information on the alternate aerodrome(s) and other relevant information specified in the filed flight plan, if such information is not available.

15.3.8 If circumstances indicate that a controlled flight experiencing a communication failure might proceed to (one of) the alternate aerodrome(s) specified in the filed flight plan, the air traffic control unit(s) serving the alternate aerodrome(s) and any other air traffic control units that might be affected by a possible diversion shall be informed of the circumstances of the failure and requested to attempt to establish communication with the aircraft at a time when the aircraft could possibly be within communication range. This shall apply particularly when, by agreement with the operator or a designated representative, a clearance has been transmitted blind to the aircraft concerned to proceed to an alternate aerodrome, or when meteorological conditions at the aerodrome of intended landing are such that a diversion to an alternate is considered likely.

15.3.9 When an air traffic control unit receives information that an aircraft, after experiencing a communication failure has re-established communication or has landed, that unit shall inform the air traffic services unit in whose area the aircraft was operating at the time the failure occurred, and other air traffic services units concerned along the route of flight, giving necessary information for the continuation of control if the aircraft is continuing in flight.

15.3.10 If the aircraft has not reported within thirty minutes after:

- a) the estimated time of arrival furnished by the pilot;
- b) the estimated time of arrival calculated by the ACC; or
- c) the last acknowledged expected approach time, whichever is latest, pertinent information concerning the aircraft shall be forwarded to aircraft operators, or their designated representatives, and pilots-in-command of any aircraft concerned and normal control resumed if they so desire. It is the responsibility of the aircraft operators, or their designated representatives, and pilots-in-command of aircraft to determine whether they will resume normal operations or take other action.

15.4 ASSISTANCE TO VFR FLIGHTS

15.4.1 Strayed VFR flights and VFR flights encountering adverse meteorological conditions

Note.— A strayed aircraft is an aircraft which has deviated significantly from its intended track or which reports that it is lost.

15.4.1.1 A VFR flight reporting that it is uncertain of its position or lost, or encountering adverse meteorological conditions, should be considered to be in a state of emergency and handled as such. The controller shall, under such circumstances, communicate in a clear, concise and calm manner and care shall be taken, at this stage, not to question any fault or negligence that the pilot may have committed in the preparation or conduct of the flight. Depending on the circumstances, the pilot should be requested to provide any of the following information considered pertinent so as to better provide assistance:

- a) aircraft flight conditions;
- b) position (if known) and level;
- c) airspeed and heading since last known position, if pertinent;
- d) pilot experience;
- e) navigation equipment carried and if any navigation aid signals are being received;
- f) SSR mode and code selected if relevant;
- g) ADS-B capability;
- h) departure and destination aerodromes;
- i) number of persons on board;
- j) endurance.

15.4.1.2 If communications with the aircraft are weak or distorted, it should be suggested that the aircraft climb to a higher level, provided meteorological conditions and other circumstances permit.

15.4.1.3 Navigation assistance to help the pilot determine the aircraft position may be provided by use of an ATS surveillance system, navigation aids or sighting by another aircraft. Care shall be taken when providing navigation assistance to ensure that the aircraft does not enter cloud.

Note.— The possibility of a VFR flight becoming strayed as a result of encountering adverse meteorological conditions shall be recognized.

15.4.1.4 The pilot should be provided with reports and information on suitable aerodromes in the vicinity where visual meteorological conditions exist.

15.4.1.5 If reporting difficulty in maintaining or unable to maintain VMC, the pilot should be informed of the minimum flight altitude of the area where the aircraft is, or is believed to be. If the aircraft is below that level, and the position of the aircraft has

been established with a sufficient degree of probability, a track or heading, or a climb, may be suggested to bring the aircraft to a safe level.

15.4.1.6 Assistance to a VFR flight should only be provided using an ATS surveillance system upon the request or concurrence of the pilot. The type of service to be provided should be agreed with the pilot.

15.4.1.7 When providing such assistance in adverse meteorological conditions, the primary objective should be to bring the aircraft into VMC as soon as possible. Caution shall be exercised to prevent the aircraft from entering cloud.

15.4.1.8 Should circumstances be such that IMC cannot be avoided by the pilot, the following guidelines may be followed:

- a) other traffic on the ATC frequency not able to provide any assistance may be instructed to change to another frequency to ensure uninterrupted communications with the aircraft; alternatively the aircraft being assisted may be instructed to change to another frequency;
- b) ensure, if possible, that any turns by the aircraft are carried out clear of cloud;
- c) instructions involving abrupt manoeuvres should be avoided; and
- d) instructions or suggestions to reduce speed of the aircraft or to lower the landing gear, should, if possible, be carried out clear of cloud.

15.5 OTHER IN-FLIGHT CONTINGENCIES

Note.— The texts of 15.5.1 and 15.5.2 are reproduced from ICAO Annex 11, Chapter 2, and have the status of Standards.

15.5.1 Strayed or unidentified aircraft

Note 1.— The terms “strayed aircraft” and “unidentified aircraft” in this paragraph have the following meanings:

Strayed aircraft. *An aircraft which has deviated significantly from its intended track or which reports that it is lost.*

Unidentified aircraft. *An aircraft which has been observed or reported to be operating in a given area but whose identity has not been established.*

Note 2.— An aircraft may be considered, at the same time, as a “strayed aircraft” by one unit and as an “unidentified aircraft” by another unit.

Note 3.— A strayed or unidentified aircraft may be suspected as being the subject of unlawful interference. See ICAO Annex 11, 2.24.1.3.

15.5.1.1 As soon as an air traffic services unit becomes aware of a strayed aircraft, it shall take all necessary steps as outlined in 15.5.1.1.1 and 15.5.1.1.2 to assist the aircraft and to safeguard its flight.

Note.— Navigational assistance by an air traffic services unit is particularly important if the unit becomes aware of an aircraft straying, or about to stray, into an area where there is a risk of interception or other hazard to its safety.

15.5.1.1.1 If the aircraft's position is not known, the air traffic services unit shall:

- a) attempt to establish two-way communication with the aircraft, unless such communication already exists;
- b) use all available means to determine its position;
- c) inform other ATS units into whose area the aircraft may have strayed or may stray, taking into account all the factors which may have affected the navigation of the aircraft in the circumstances;
- d) inform, in accordance with locally agreed procedures, appropriate military units and provide them with pertinent flight plan and other data concerning the strayed aircraft;
- e) request from the units referred to in c) and d) and from other aircraft in flight every assistance in establishing communication with the aircraft and determining its position.

Note.— The requirements in d) and e) apply also to ATS units informed in accordance with c).

15.5.1.1.2 When the aircraft's position is established, the air traffic services unit shall:

- a) advise the aircraft of its position and corrective action to be taken; and
- b) provide, as necessary, other ATS units and appropriate military units with relevant information concerning the strayed aircraft and any advice given to that aircraft.

15.5.1.2 As soon as an air traffic services unit becomes aware of an unidentified aircraft in its area, it shall endeavour to establish the identity of the aircraft whenever this is necessary for the provision of air traffic services or required by the appropriate military authorities in accordance with locally agreed procedures. To this end, the air traffic services unit shall take such of the following steps as are appropriate in the circumstances:

- a) attempt to establish two-way communication with the aircraft;
- b) inquire of other air traffic services units within the FIR about the flight and request their assistance in establishing two-way communication with the aircraft;

- c) inquire of air traffic services units serving the adjacent FIRs about the flight and request their assistance in establishing two-way communication with the aircraft;
- d) attempt to obtain information from other aircraft in the area.

15.5.1.2.1 The air traffic services unit shall, as necessary, inform the appropriate military unit as soon as the identity of the aircraft has been established.

Note.— Requirements for coordination between military authorities and air traffic services are specified in ICAO Annex 11, 2.16.

15.5.1.3 Should the ATS unit consider that a strayed or unidentified aircraft may be the subject of unlawful interference, the appropriate authority shall immediately be informed, in accordance with locally agreed procedures.

15.5.2 Interception of civil aircraft

15.5.2.1 As soon as an air traffic services unit learns that an aircraft is being intercepted in its area of responsibility, it shall take such of the following steps as are appropriate in the circumstances:

- a) attempt to establish two-way communication with the intercepted aircraft via any means available, including the emergency frequency 121.5 MHz, unless such communication already exists;
- b) inform the pilot of the intercepted aircraft of the interception;
- c) establish contact with the intercept control unit maintaining two-way communication with the intercepting aircraft and provide it with available information concerning the aircraft;
- d) relay messages between the intercepting aircraft or the intercept control unit and the intercepted aircraft, as necessary;
- e) in close coordination with the intercept control unit take all necessary steps to ensure the safety of the intercepted aircraft; and
- f) inform ATS units serving adjacent FIRs if it appears that the aircraft has strayed from such adjacent FIRs.

15.5.2.2 As soon as an air traffic services unit learns that an aircraft is being intercepted outside its area of responsibility, it shall take such of the following steps as are appropriate in the circumstances:

- a) inform the ATS unit serving the airspace in which the interception is taking place, providing this unit with available information that will assist in identifying the aircraft and requesting it to take action in accordance with 15.5.2.1;
- b) relay messages between the intercepted aircraft and the appropriate ATS unit, the intercept control unit or the intercepting aircraft.

15.5.3 Fuel dumping

15.5.3.1 GENERAL

15.5.3.1.1 An aircraft in an emergency or other urgent situations may need to dump fuel so as to reduce to maximum landing mass in order to effect a safe landing.

15.5.3.1.2 When an aircraft operating within controlled airspace needs to dump fuel, the flight crew shall advise ATC. The ATC unit should then coordinate with the flight crew the following:

- a) the route to be flown, which, if possible, should be clear of cities and towns, preferably over water and away from areas where thunderstorms have been reported or are expected;
- b) the level to be used, which should be not less than 1 800 m (6 000 ft); and
- c) the duration of the fuel dumping.

15.5.3.2 SEPARATION

Other known traffic should be separated from the aircraft dumping fuel by:

- a) at least 19 km (10 NM) horizontally, but not behind the aircraft dumping fuel;
- b) vertical separation if behind the aircraft dumping fuel within 15 minutes flying time or a distance of 93 km (50 NM) by:
 - 1) at least 300 m (1 000 ft) if above the aircraft dumping fuel; and
 - 2) at least 900 m (3 000 ft) if below the aircraft dumping fuel.

Note.— The horizontal boundaries of the area within which other traffic requires appropriate vertical separation extend for 19 km (10 NM) either side of the track flown by the aircraft which is dumping fuel, from 19 km (10 NM) ahead, to 93 km (50 NM) or 15 minutes along track behind it (including turns).

15.5.3.3 COMMUNICATIONS

If the aircraft will maintain radio silence during the fuel dumping operation, the frequency to be monitored by the flight crew and the time when radio silence will terminate should be agreed.

15.5.3.4 INFORMATION TO OTHER ATS UNITS AND NON-CONTROLLED TRAFFIC

15.5.3.4.1 A warning message shall be broadcast on appropriate frequencies for non-controlled traffic to remain clear of the area concerned. Adjacent ATC units and control sectors should be informed of the fuel dumping taking place and requested to

broadcast on applicable frequencies an appropriate warning message for other traffic to remain clear of the area concerned.

15.5.3.4.2 Upon completion of the fuel dumping, adjacent ATC units and control sectors should be advised that normal operations can be resumed.

15.5.4 Fuel emergency and minimum fuel

Note 1. — General procedures to be applied when a pilot reports an emergency situation are contained in 15.1.1 and 15.1.2.

Note 2. — Coordination procedures to be applied between transferring and accepting ATS units for flights in fuel emergency or minimum fuel situations are contained in Chapter 10, 10.2.5.

Note 3. — The words MAYDAY FUEL described the nature of the distress condition as required in Annex 10, Volume II, 5.3.2.1.1 b) 3.

15.5.4.1 When a pilot reports a state of minimum fuel, the controller shall inform the pilot as soon as practicable of any anticipated delays or that no delays are expected.

Note 1. — The declaration of MINIMUM FUEL informs ATC that all planned aerodrome options have been reduced to a specific aerodrome of intended landing and any change to the existing clearance may result in landing with less than planned final reserve fuel. This is not an emergency situation but an indication that an emergency situation is possible should any additional delay occur.

15.5.5 Descents by supersonic aircraft due to solar cosmic radiation

Note: This section is reserved.

15.6 ATC CONTINGENCIES

The various circumstances surrounding each contingency situation preclude the establishment of exact detailed procedures to be followed. The procedures outlined below are intended as a general guide to air traffic services personnel.

15.6.1 Radiocommunications contingencies

15.6.1.1 GENERAL

ATC contingencies related to communications, i.e. circumstances preventing a controller from communicating with aircraft under control, may be caused by either a failure of ground radio equipment, a failure of airborne equipment, or by the control frequency being inadvertently blocked by an aircraft transmitter. The duration of such events may be for prolonged periods and appropriate action to ensure that the safety of aircraft is not affected should therefore be taken immediately.

15.6.1.2 GROUND RADIO FAILURE

15.6.1.2.1 In the event of complete failure of the ground radio equipment used for ATC, the controller shall:

- a) where aircraft are required to keep a listening watch on the emergency frequency 121.5 MHz, attempt to establish radiocommunications on that frequency;
- b) without delay inform all adjacent control positions or ATC units, as applicable, of the failure;
- c) appraise such positions or units of the current traffic situation;
- d) if practicable, request their assistance, in respect of aircraft which may establish communications with those positions or units, in establishing separation between and maintaining control of such aircraft; and
- e) instruct adjacent control positions or ATC units to hold or re-route all controlled flights outside the area of responsibility of the position or ATC unit that has experienced the failure until such time that the provision of normal services can be resumed.

15.6.1.2.2 In order to reduce the impact of complete ground radio equipment failure on the safety of air traffic, the ANSP should establish contingency procedures to be followed by control positions and ATC units in the event of such failures. Where feasible and practicable, such contingency procedures should provide for the delegation of control to an adjacent control position or ATC unit in order to permit a minimum level of services to be provided as soon as possible, following the ground radio failure and until normal operations can be resumed.

15.6.1.3 BLOCKED FREQUENCY

In the event that the control frequency is inadvertently blocked by an aircraft transmitter, the following additional steps should be taken:

- a) attempt to identify the aircraft concerned;
- b) if the aircraft blocking the frequency is identified, attempts should be made to establish communication with that aircraft, e.g. on the emergency frequency 121.5 MHz, by SELCAL, through the aircraft operator's company frequency if applicable, on any VHF frequency designated for air-to-air use by flight crews or any other communication means or, if the aircraft is on the ground, by direct contact;
- c) if communication is established with the aircraft concerned, the flight crew shall be instructed to take immediate action to stop inadvertent transmissions on the affected control frequency.

15.6.1.4 UNAUTHORIZED USE OF ATC FREQUENCY

15.6.1.4.1 Instances of false and deceptive transmissions on ATC frequencies which may impair the safety of aircraft can occasionally occur. In the event of such occurrences, the ATC unit concerned should:

- a) correct any false or deceptive instructions or clearances which have been transmitted;
- b) advise all aircraft on the affected frequency(ies) that false and deceptive instructions or clearances are being transmitted;
- c) instruct all aircraft on the affected frequency(ies) to verify instructions and clearances before taking action to comply;
- d) if practical, instruct aircraft to change to another frequency; and
- e) if possible, advise all aircraft affected when the false and deceptive instructions or clearances are no longer being transmitted.

15.6.1.4.2 Flight crews shall challenge or verify with the ATC unit concerned any instruction or clearance issued to them which they suspect may be false or deceptive.

15.6.1.4.3 When the transmission of false or deceptive instructions and clearances is detected, the appropriate authority shall take all necessary action to have the transmitter located and the transmission terminated.

15.7 OTHER ATC CONTINGENCY PROCEDURES

15.7.1 Emergency separation

15.7.1.1 If, during an emergency situation, it is not possible to ensure that the applicable horizontal separation can be maintained, emergency separation of half the applicable vertical separation minimum may be used, i.e. 150 m (500 ft) between aircraft in airspace where a vertical separation minimum of 300 m (1 000 ft) is applied, and 300 m (1 000 ft) between aircraft in airspace where a 600 m (2 000 ft) vertical separation minimum is applied.

15.7.1.2 When emergency separation is applied the flight crews concerned shall be advised that emergency separation is being applied and informed of the actual minimum used. Additionally, all flight crews concerned shall be provided with essential traffic information.

15.7.2 Short-term conflict alert (STCA) procedures

Note 1.— The generation of short-term conflict alerts is a function based on surveillance data, integrated into an ATC system. The objective of the STCA function is to assist the controller in preventing collision between aircraft by generating, in a timely manner, an alert of a potential or actual infringement of separation minima.

Note 2. — In the STCA function the current and predicted three-dimensional positions of aircraft with pressure-altitude reporting capability are monitored for proximity. If the distance between the three-dimensional positions of two aircraft is predicted to be reduced to less than the defined applicable separation minima within a specified time period, an acoustic and/or visual alert will be generated to the controller within whose jurisdiction area the aircraft is operating.

15.7.2.1 Local instructions concerning use of the STCA function shall specify, *inter alia*:

- a) the types of flight which are eligible for generation of alerts;
- b) the sectors or areas of airspace within which the STCA function is implemented;
- c) the method of displaying the STCA to the controller;
- d) in general terms, the parameters for generation of alerts as well as alert warning time;
- e) the volumes of airspace within which STCA can be selectively inhibited and the conditions under which this will be permitted;
- f) conditions under which specific alerts may be inhibited for individual flights; and
- g) procedures applicable in respect of volume of airspace or flights for which STCA or specific alerts have been inhibited.

15.7.2.2 In the event an STCA is generated in respect of controlled flights, the controller shall without delay assess the situation and, if necessary, take action to ensure that the applicable separation minimum will not be infringed or will be restored.

15.7.2.3 Following the generation of an STCA, controllers should be required to complete an air traffic incident report only in the event that a separation minimum was infringed.

15.7.2.4 The ANSP should retain electronic records of all alerts generated. The data and circumstances pertaining to each alert should be analysed to determine whether an alert was justified or not. Non-justified alerts, e.g. when visual separation was applied, should be ignored. A statistical analysis should be made of justified alerts in order to identify possible shortcomings in airspace design and ATC procedures as well as to monitor overall safety levels.

15.7.3 Procedures in regard to aircraft equipped with airborne collision avoidance systems (ACAS)

15.7.3.1 The procedures to be applied for the provision of air traffic services to aircraft equipped with ACAS shall be identical to those applicable to non-ACAS equipped aircraft. In particular, the prevention of collisions, the establishment of appropriate separation and the information which might be provided in relation to

conflicting traffic and to possible avoiding action shall conform with the normal ATS procedures and shall exclude consideration of aircraft capabilities dependent on ACAS equipment.

15.7.3.2 When a pilot reports an ACAS resolution advisory (RA), the controller shall not attempt to modify the aircraft flight path until the pilot reports “Clear of Conflict”.

15.7.3.3 Once an aircraft departs from its ATC clearance or instruction in compliance with an RA, or a pilot reports an RA, the controller ceases to be responsible for providing separation between that aircraft and any other aircraft affected as a direct consequence of the manoeuvre induced by the RA. The controller shall resume responsibility for providing separation for all the affected aircraft when:

- a) the controller acknowledges a report from the flight crew that the aircraft has resumed the current clearance; or
- b) the controller acknowledges a report from the flight crew that the aircraft is resuming the current clearance and issues an alternative clearance which is acknowledged by the flight crew.

Note.— Pilots are required to report RAs which require a deviation from the current ATC clearance or instruction (see PANS-OPS (Doc 8168), Volume I, Part III, Section 3, Chapter 3, 3.2 c) 4)). This report informs the controller that a deviation from clearance or instruction is taking place in response to an ACAS RA.

15.7.3.4 Guidance on training of air traffic controllers in the application of ACAS events is contained in the *Airborne Collision Avoidance System (ACAS) Manual* (Doc 9863).

15.7.3.5 ACAS can have a significant effect on ATC. Therefore, the performance of ACAS in the ATC environment should be monitored.

15.7.3.6 Following a significant ACAS event, pilots and controllers should complete an air traffic incident report.

Note 1.— The ACAS capability of an aircraft may not be known to air traffic controllers.

Note 2.— Operating procedures for use of ACAS are contained in PANS-OPS (Doc 8168), Volume I, Part III, Section 3, Chapter 3.

Note 3.— The phraseology to be used by controllers and pilots is contained in Chapter 12, 12.3.1.2.

15.7.4 Minimum safe altitude warning (MSAW) procedures

Note 1.— The generation of minimum safe altitude warnings is a function of an ATC radar data-processing system. The objective of the MSAW function is to assist in the prevention of controlled flight into terrain accidents by generating, in a timely manner, a warning of the possible infringement of a minimum safe altitude.

Note 2.— In the MSAW function, the reported levels from aircraft with pressure-altitude reporting capability are monitored against defined minimum safe altitudes. When the level of an aircraft is detected or predicted to be less than the applicable minimum safe altitude, an acoustic and visual warning will be generated to the controller within whose jurisdiction area the aircraft is operating.

15.7.4.1 Local instructions concerning use of the MSAW function shall specify, *inter alia*:

- a) the types of flight which are eligible for generation of MSAW;
- b) the sectors or areas of airspace for which MSAW minimum safe altitudes have been defined and within which the MSAW function is implemented;
- c) the values of the defined MSAW minimum safe altitudes;
- d) the method of displaying the MSAW to the controller;
- e) the parameters for generation of MSAW as well as warning time; and
- f) conditions under which the MSAW function may be inhibited for individual aircraft tracks as well as procedures applicable in respect of flights for which MSAW has been inhibited.

15.7.4.2 In the event an MSAW is generated in respect of a controlled flight, the following action shall be taken without delay:

- a) if the aircraft is being vectored, the aircraft shall be instructed to climb immediately to the applicable safe level and, if necessary to avoid terrain, be assigned a new heading;
- b) in other cases, the flight crew shall immediately be advised that a minimum safe altitude warning has been generated and be instructed to check the level of the aircraft.

15.7.4.3 Following an MSAW event, controllers should complete an air traffic incident report only in the event that a minimum safe altitude was unintentionally infringed with a potential for controlled flight into terrain by the aircraft concerned.

15.7.5 Change of radiotelephony call sign for aircraft

15.7.5.1 An ATC unit may instruct an aircraft to change its type of RTF call sign, in the interests of safety, when similarity between two or more aircraft RTF call signs are such that confusion is likely to occur.

15.7.5.1.1 Any such change to the type of call sign shall be temporary and shall be applicable only within the airspace(s) where the confusion is likely to occur.

15.7.5.2 To avoid confusion, the ATC unit should, if appropriate, identify the aircraft which will be instructed to change its call sign by referring to its position and/or level.

15.7.5.3 When an ATC unit changes the type of call sign of an aircraft, that unit shall ensure that the aircraft reverts to the call sign indicated by the flight plan when the aircraft is transferred to another ATC unit, except when the call sign change has been coordinated between the two ATC units concerned.

15.7.5.4 The appropriate ATC unit shall advise the aircraft concerned when it is to revert to the call sign indicated by the flight plan.

15.8 PROCEDURES FOR AN ATC UNIT WHEN A VOLCANIC ASH CLOUD IS REPORTED OR FORECAST

15.8.1 If a volcanic ash cloud is reported or forecast in the FIR for which the ACC is responsible, the controller should:

- a) relay all information available immediately to pilots whose aircraft could be affected to ensure that they are aware of the ash cloud's position and the flight levels affected;
- b) suggest appropriate re-routing to the flight crew to avoid an area of known or forecast ash clouds;
- c) inform pilots that volcanic ash clouds are not detected by relevant ATS surveillance systems;
- d) if the ACC has been advised by an aircraft that it has entered a volcanic ash cloud the controller should:
 - 1) consider the aircraft to be in an emergency situation;
 - 2) not initiate any climb clearances to turbine-powered aircraft until the aircraft has exited the ash cloud; and
 - 3) not initiate vectoring without pilot concurrence.

Note.— Experience has shown that the recommended escape manoeuvre for an aircraft which has encountered an ash cloud is to reverse its course and begin a descent if terrain permits. The final responsibility for this decision, however, rests with the pilot.

15.8.2 The ANSP should develop appropriate procedures and contingency routings for avoidance of volcanic ash clouds and fulfil its obligations to ensure safety of aircraft.

15.8.3 Controllers should be trained in procedures for avoidance of volcanic ash clouds and be made aware that turbine-engine aircraft encountering an ash cloud may suffer a complete loss of power. Controllers should take extreme caution to ensure that aircraft do not enter volcanic ash clouds.

Note 1.— There are no means to detect the density of a volcanic ash cloud or the size distribution of its particles and their subsequent impact on engine performance and the integrity of the aircraft.

Note 2.— Guidance material is provided in Chapters 4 and 5 of the Manual on Volcanic Ash, Radioactive Material and Toxic Chemical Clouds (Doc 9691).

15.9 CONTINGENCY ARRANGEMENTS

The ANSP shall develop and promulgate contingency plans for implementation in the event of disruption, or potential disruption, of air traffic services and related supporting services in the airspace for which they are responsible for the provision of such services. Such contingency plans shall be developed with the assistance of ICAO as necessary, in close coordination with the air traffic services authorities responsible for the provision of services in adjacent portions of airspace and with airspace users concerned.

Note 1.— Guidance material relating to the development, promulgation and implementation of contingency plans is contained in ICAO Annex 11, Attachment C.

Note 2.— Contingency plans may constitute a temporary deviation from the approved regional air navigation plans; such deviations are approved, as necessary, by the President of the ICAO Council on behalf of the Council.

CHAPTER 16

MISCELLANEOUS PROCEDURES

16.1 RESPONSIBILITY IN REGARD TO MILITARY TRAFFIC

16.1.1 It is recognized that some military aeronautical operations necessitate non-compliance with certain air traffic procedures. In order to ensure the safety of flight operations the appropriate military authorities shall be asked, whenever practicable, to notify the proper air traffic control unit prior to undertaking such manoeuvres.

16.1.2 A reduction of separation minima required by military necessity or other extraordinary circumstances shall only be accepted by an air traffic control unit when a specific request in some recorded form has been obtained from the authority having jurisdiction over the aircraft concerned and the lower minima then to be observed shall apply only between those aircraft. Some recorded form of instruction fully covering this reduction of separation minima shall be issued by the air traffic control unit concerned.

16.1.3 Aircraft shall not be flown in formation except by prearrangement among the pilots-in-command of the aircraft taking part in the flight and, for formation flight in controlled airspace, in accordance with the following conditions:

- a) the formation operates as a single aircraft with regard to navigation and position reporting;
- b) separation between aircraft in the flight shall be the responsibility of the flight leader and the pilots-in-command of the other aircraft in the flight and shall include periods of transition when aircraft are manoeuvring to attain their own separation within the formation and during join-up and breakaway; and
- c) a distance not exceeding 1 km (0.5 NM) laterally and longitudinally and 30 m (100 ft) vertically from the flight leader shall be maintained by each aircraft.

16.1.4 Temporary airspace reservation, either stationary or mobile, may be established for the use of large formation flights or other military air operations. Arrangements for the reservation of such airspace as well as safe access by other airspace users to such reserved airspace shall be accomplished by coordination between the user and the ANSP. Additionally, the coordination of other activities potentially hazardous to civil aircraft shall be effected in accordance with the provisions of ICAO Annex 11, Chapter 2 and completed early enough to permit timely promulgation of information in accordance with the provisions of ICAO Annex 15.

16.2 RESPONSIBILITY IN REGARD TO UNMANNED FREE BALLOONS

16.2.1 On receipt of notification of the intended flight of a medium or heavy unmanned free balloon, the air traffic services unit shall arrange for the information to be disseminated to all concerned. The information shall include:

- a) the balloon flight identification or project code name;
- b) balloon classification and description;
- c) SSR code or NDB frequency as applicable;
- d) the launch site;
- e) the estimated time of the commencement of the launch or the planned period of the launches;
- f) the expected direction of ascent;
- g) the cruising level(s) (pressure-altitude); and
- h) the estimated elapsed time to pass 18 000 m (60 000 ft) pressure-altitude, or to reach cruising level if at or below 18 000 m (60 000 ft), together with the estimated location.

16.2.2 On receipt of notification that a medium or heavy unmanned free balloon has been launched, the air traffic services unit shall arrange for the information to be disseminated to all concerned. The information shall include:

- a) the balloon flight identification or project code name;
- b) balloon classification and description;
- c) SSR code or NDB frequency as applicable;
- d) the launch site;
- e) the time of launch(es);
- f) the estimated time at which 18 000 m (60 000 ft) pressure-altitude will be passed, or the estimated time at which the cruising level will be reached if at or below 18 000 m (60 000 ft), and the estimated location;
- g) the estimated date and time of termination of the flight; and
- h) the planned location of ground contact, when applicable.

16.2.3 When there is reasonable expectation that a heavy or medium unmanned free balloon will cross international borders, the appropriate ATS unit shall arrange for the pre-launch and the launch notifications to be sent by NOTAM to the ATS unit(s) in the State(s) concerned. The launch notification may be transmitted orally by direct ATS speech circuit between the ACCs/flight information centres involved.

16.2.4 Air traffic services units shall maintain radar and/or ADS-B surveillance of medium and heavy unmanned free balloons to the extent possible and, if necessary and on the request of the pilot of an aircraft, provide separation using an ATS surveillance system between the aircraft and such balloons which are identified or their exact position is known.

16.3 REPORTING OF SAFETY OCCURRENCES

16.3.1 The ANSP must make a report to the ANS Regulator if the ANSP has knowledge of any reportable safety matter specified in paragraph 16.3.2.

16.3.2 The report must be made to the ANS Regulator immediately through the most expeditious means available, upon becoming aware of the matter, or as soon as practicable.

16.3.3 The ANSP must submit a formal written notification to the ANS Regulator within 72 hours after a report is made under paragraph 16.3.2.

16.3.4 A reportable safety occurrence refers to –

- (a) an accident;
- (b) an incident or serious incident involving –
 - (i) near collision that requires avoidance manoeuvre to avoid a collision between:
 - (a) two or more aircraft; or
 - (b) an aircraft and a vehicle, person or object;
 - (ii) a controlled flight into terrain that is marginally avoided; or
 - (iii) loss of separation or an AIRPROX event;
- (c) a take-off, landing, or runway/taxiway incident including –
 - (i) an aircraft take-off or landing without ATC clearance;
 - (ii) an aircraft taking off, attempting to take off or a rejected take-off on a closed or engaged runway, on a taxiway or an unassigned runway;

- (iii) an aircraft landing on or making an approach to a closed or engaged runway, a taxiway or an unassigned runway;
 - (iv) a runway excursion;
 - (v) a runway incursion by an aircraft, vehicle or person(s); and
- (d) an ATC-related or airspace occurrence where –
- (i) an aircraft deviates from ATC clearance;
 - (ii) an aircraft deviates from the published airspace restrictions in the Air Navigation Order; or
 - (iii) an aircraft deviates from applicable ATM procedures documented in the Singapore AIP and NOTAMs.
- (e) the incapacitation of an air traffic controller while on duty;
- (f) any other occurrence of which the ANSP reasonably knows that has a significant safety impact to aircraft operation.

16.3.5 The ANSP must establish procedures, and document the procedures into the ANSP's manual, for the reporting of the above mentioned reportable occurrences.

16.3.6 In this paragraph, unless the context otherwise requires –

“accident” has the meaning given in Annex 13 to Chicago Convention;

“incapacitation” means any reduction in the well-being of an air traffic controller by any cause such as injury, sickness, fatigue, or the effects of psychoactive substances to a degree or of a nature that adversely affects his or her capacity to maintain vigilant engagement, physically or mentally, when providing air traffic services.

16.3A INVESTIGATION OF SAFETY OCCURRENCES

16.3A.1 The ANSP must conduct an investigation for –

- (a) an accident or incident categorised under 16.3.4(b)(iii), (c)(iv) and (c)(v); and
- (b) any other occurrence when required by the ANS Regulator.

16.3A.2 The ANS Regulator may require the ANSP to submit the completed investigation report of an investigation conducted under 16.3A.1(a).

16.4 USE OF REPETITIVE FLIGHT PLANS (RPLS)

16.4.1 General

16.4.1.1 RPLs shall not be used for flights other than IFR flights operated regularly on the same day(s) of consecutive weeks and on at least ten occasions or every day over a period of at least ten consecutive days. The elements of each flight plan shall have a high degree of stability.

Note.— For permissible incidental changes to RPL data affecting the operation for one particular day, and not intended to be a modification of the listed RPL, see 16.4.4.2.2 and 16.4.4.2.3.

16.4.1.2 RPLs shall cover the entire flight from the departure aerodrome to the destination aerodrome. RPL procedures shall be applied only when all ATS authorities concerned with the flights have agreed to accept RPLs.

16.4.1.3 The use of RPLs for international flight shall be subject to the provision that the affected adjacent States either already use RPLs or will use them at the same time.

16.4.2 Procedures for submission of RPLs by operators

16.4.2.1 Conditions governing submission, notification of changes, or cancellation of RPLs shall be the subject of appropriate arrangements between operators and the ANSP.

16.4.2.2 An RPL shall comprise information regarding such of the following items as are considered relevant by the ANSP:

- validity period of the flight plan
- days of operation
- aircraft identification
- aircraft type and wake turbulence category
- MLS capability
- departure aerodrome
- off-block time
- cruising speed(s)
- cruising level(s)
- route to be followed
- destination aerodrome
- total estimated elapsed time
- indication of the location where the following information may be obtained immediately upon request:
 - alternate aerodromes
 - fuel endurance
 - total number of persons on board
 - emergency equipment
- other information.

16.4.3 Submission of total listings

16.4.3.1 RPLs shall be submitted in the form of listings containing the required flight plan data using an RPL listing form specially designed for the purpose or by means of other media suitable for electronic data processing.

Note.— A model RPL listing form is contained in **Appendix 2**.

16.4.3.2 Initial submission of complete RPL listings and any subsequent seasonal resubmission of complete listings shall be made in sufficient time to permit the data to be properly assimilated by the ATS organization. The minimum lead time required for the submission of such listings shall be established by the administrations concerned and published in their AIPs. This minimum lead time shall be at least two weeks.

16.4.3.3 Operators shall submit listings to the designated agency for distribution to the appropriate air traffic services units.

16.4.3.4 The information normally to be provided shall be that listed in 16.4.2.2 except that administrations may also require the provision of estimate information of FIR boundaries and the primary alternate aerodrome. If so required, such information shall be provided as indicated on an RPL listing form specially designed for the purpose.

16.4.3.5 Information regarding alternate aerodrome(s) and supplementary flight plan data (information normally provided under Item 19 of the ICAO flight plan form) shall be kept readily available by the operator at the departure aerodrome or another agreed location, so that, on request by ATS units, it can be supplied without delay. The name of the office from which the information can be obtained shall be recorded on the RPL listing form.

16.4.3.6 Acknowledgement of receipt of listings of flight plan data and/or amendment thereto shall not be required except by agreement between operators and the appropriate agency.

16.4.4 Changes to RPL listings

16.4.4.1 CHANGES OF A PERMANENT NATURE

16.4.4.1.1 Changes of a permanent nature involving the inclusion of new flights and the deletion or modification of currently listed flights shall be submitted in the form of amendment listings. These listings shall reach the air traffic services agency concerned at least seven days prior to the change becoming effective.

16.4.4.1.2 Where RPL listings have been initially submitted by the use of media suitable for electronic data processing, it shall be permissible by mutual agreement between the operator and the appropriate authority for some changes to be submitted by means of RPL listing forms.

16.4.4.1.3 All RPL changes shall be submitted in accordance with the instructions for preparation of RPL listings.

16.4.4.2 CHANGES OF A TEMPORARY NATURE

16.4.4.2.1 Changes of a temporary, non-recurring nature relating to RPLs concerning aircraft type and wake turbulence category, speed and/or cruising level shall be notified for each individual flight as early as possible and not later than 30 minutes before departure to the ATS reporting office responsible for the departure aerodrome. A change of cruising level only may be notified by radiotelephony on initial contact with the ATS unit.

16.4.4.2.2 In case of an incidental change in the aircraft identification, the departure aerodrome, the route and/or the destination aerodrome, the RPL shall be cancelled for the day concerned and an individual flight plan shall be submitted.

16.4.4.2.3 Whenever it is expected by the operator that a specific flight, for which an RPL has been submitted, is likely to encounter a delay of 30 minutes or more in excess of the off-block time stated in that flight plan, the ATS unit responsible for the departure aerodrome shall be notified immediately.

Note.— Because of the stringent requirements of flow control, failure by operators to comply with this procedure may result in the automatic cancellation of the RPL for that specific flight at one or more of the ATS units concerned.

16.4.4.2.4 Whenever it is known to the operator that any flight for which an RPL has been submitted is cancelled, the ATS unit responsible for the departure aerodrome shall be notified.

16.4.4.3 OPERATOR/PILOT LIAISON

The operator shall ensure that the latest flight plan information, including permanent and incidental changes, pertaining to a particular flight and duly notified to the appropriate agency, is made available to the pilot-in-command.

16.4.4.4 RPL PROCEDURES FOR ATS UNITS

The procedures for handling RPLs described herein are applicable regardless of whether automatic data-processing equipment is utilized or flight plan data is handled manually.

16.4.4.5 IMPLEMENTATION OF RPL PROCEDURES

16.4.4.5.1 Procedures for use of RPLs may be established for flights operating within a single FIR or a single State.

16.4.4.5.2 Procedures may also be established for flights across international boundaries subject to the provision that affected States currently utilize or will concurrently use RPLs.

16.4.4.5.3 Application of RPL procedures for international flights requires the establishment of bilateral or multilateral agreements between the ANSPs concerned.

16.4.4.5.4 Application of RPLs requires agreements with participating operators to establish submission and amendment procedures.

16.4.4.5.5 Agreements shall include provisions for the following procedures:

- a) initial submission;
- b) permanent changes;
- c) temporary and incidental changes;
- d) cancellations;
- e) additions; and
- f) completely revised listings when indicated by extensive changes.

16.4.4.6 COLLECTION, STORAGE AND PROCESSING OF RPL DATA

16.4.4.6.1 The ANSP using RPLs shall designate one or more agencies responsible for administering such data. The area of responsibility for any such designated agency shall be at least one FIR. Each designated agency shall distribute relevant RPL data to the ATS units concerned within its area of responsibility so that such data reach these units in sufficient time to become effective.

16.4.4.6.2 RPLs shall be stored by each ATS unit concerned in a manner that will ensure that they are systematically activated on the appropriate day of operation in the order of estimated times indicative of entry into the unit's area of responsibility. Activation shall be accomplished in sufficient time to present the data to the controller in appropriate form for analysis and control action.

16.4.4.7 SUSPENSION OF RPL PROCEDURES

The ANSP obliged, due to exceptional circumstances, to temporarily suspend the use of RPLs in its area of responsibility, or a specified part thereof, shall publish notice of such suspension with as much advance notice as possible and in the most suitable form considering the circumstances.

16.4.4.8 ATS MESSAGES RELATED TO INDIVIDUAL FLIGHTS OPERATING ON AN RPL

ATS messages relating to individual flights operating on an RPL shall be originated and addressed to ATS units concerned in a manner identical to that used for flights operating on individual flight plans.

16.5 STRATEGIC LATERAL OFFSETS PROCEDURES (SLOP) IN OCEANIC AND REMOTE CONTINENTAL AIRSPACE

16.5.1 SLOP are approved procedures that allow aircraft to fly on a parallel track to the right of the centre line relative to the direction of flight. An aircraft's use of these procedures does not affect the application of prescribed separation standards.

Note 1.— The use of highly accurate navigation systems (such as the global navigation satellite system (GNSS)) by an increasing proportion of the aircraft population has had the effect of reducing the magnitude of lateral deviations from the route centre line and, consequently, increasing the probability of a collision, should a loss of vertical separation between aircraft on the same route occur.

Note 2.— The following incorporates lateral offset procedures for both the mitigation of the increasing lateral overlap probability due to increased navigation accuracy, and wake turbulence encounters.

Note 3.— ICAO Annex 2, 3.6.2.1.1, requires authorization for the application of strategic lateral offsets from the ANSP responsible for the airspace concerned.

16.5.2 The following shall be taken into account by the ANSP when authorizing the use of strategic lateral offsets in a particular airspace:

- a) strategic lateral offsets shall only be authorized in en-route oceanic or remote continental airspace. Where part of the airspace in question is provided with an ATS surveillance service, transiting aircraft should normally be allowed to initiate or continue offset tracking;
- b) strategic lateral offsets do not affect lateral separation minima and may be authorized for the following types of routes (including where routes or route systems intersect):
 - 1) uni-directional and bi-directional routes; and
 - 2) parallel route systems where the spacing between route centre lines is not less than 55.5 km (30 NM);
- c) in some instances it may be necessary to impose restrictions on the use of strategic lateral offsets, e.g. where their application may be inappropriate for reasons related to obstacle clearance;
- d) strategic lateral offset procedures should be implemented on a regional basis after coordination between all States involved;
- e) the routes or airspace where application of strategic lateral offsets is authorized, and the procedures to be followed by pilots, shall be promulgated in aeronautical information publications (AIPs); and
- f) air traffic controllers shall be made aware of the airspace within which strategic lateral offsets are authorized.

16.5.3 The decision to apply a strategic lateral offset shall be the responsibility of the flight crew. The flight crew shall only apply strategic lateral offsets in airspace where such offsets have been authorized by the appropriate ATS unit and when the aircraft is equipped with automatic offset tracking capability.

16.5.4 The strategic lateral offset shall be established at a distance of 1 NM or 2 NM to the right of the centre line relative to the direction of flight.

Note 1.— Pilots may contact other aircraft on the inter-pilot air-to-air frequency 123.45 MHz to coordinate offsets.

Note 2.— The strategic lateral offset procedure has been designed to include offsets to mitigate the effects of wake turbulence of preceding aircraft. If wake turbulence needs to be avoided, one of the three available options (centre line, 1 NM or 2 NM right offset) may be used.

Note 3.— Pilots are not required to inform ATC that a strategic lateral offset is being applied.

16.6 NOTIFICATION OF SUSPECTED COMMUNICABLE DISEASES ON BOARD AN AIRCRAFT OR OTHER PUBLIC HEALTH RISK

16.6.1 The flight crew of an en-route aircraft shall, upon identifying a suspected case(s) of communicable disease, or other public health risk, on board the aircraft, promptly notify the ATS unit with which the pilot is communicating, and provide the information listed below:

- a) aircraft identification;
- b) departure aerodrome;
- c) destination aerodrome;
- d) estimated time of arrival;
- e) number of persons on board;
- f) number of suspected case(s) on board; and
- g) nature of the public health risk, if known.

16.6.2 The ATS unit, upon receipt of information from a pilot regarding suspected case(s) of communicable disease, or other public health risk, on board the aircraft, shall forward a message as soon as possible to the ATS unit serving the destination/departure.

16.6.3 When a report is received of a suspected case(s) of communicable disease, or other public health risk, on board an aircraft is landing in Singapore, the ATS unit concerned shall notify the appropriate CAAS authority and the aircraft operator or its designated representative.

Note.— See Annex 9, Chapter 1 (Definitions), Chapter 8, 8.12 and 8.15, and Appendix 1, for relevant additional information related to the subject of communicable disease and public health risk on board an aircraft.

16.7 ATS OPERATIONS MANUAL

16.7.1 The ANSP shall provide, for compliance by its personnel, an operations manual or system of manuals for the services listed in its operations manual. The operations manual also serves as a reference document for AAR with respect to the standards, conditions and level of service to be maintained for air traffic services.

16.7.2 The contents of the operations manual should contain:

- (a) A description of the provider's organisational structure and the names, qualifications, experience and positions of the key officers of the organisation;
- (b) A statement of the duties and responsibilities of the supervisory positions within the organisational structure;
- (c) A statement showing how the provider determines the number of operational staff required, including the number of operational supervisory staff;
- (e) A statement setting out the air traffic services, and related functions, that the provider will perform;
- (d) The hours of operation of each service;
- (e) The airspace within which each service is to be provided. This may be by reference to an aeronautical chart;
- (f) If the service is an air traffic service for a controlled aerodrome:
 - (i) a chart of the manoeuvring area of the aerodrome showing all runways, taxiways, parking areas, etc.
 - (ii) extracts from the Airport Emergency Plan (AEP) relevant to the ATS functions,
 - (iii) a copy of the procedures as set out in the aerodrome manual for preventing unauthorised entry of persons or things onto the movement area of the aerodrome, and
 - (iv) a copy of the procedures set out in the aerodrome manual for the control of surface vehicles operating on or in the vicinity of the manoeuvring area;
- (g) A duty statement including the functions, responsibilities and hours of operation, of each operating position.

(h) A description of the arrangements made by the applicant to ensure that it has, and will continue to receive, the information necessary for providing each service:

(i) this requirement includes information that is both internally and externally sourced.

(ii) the description should nominate the information requirement, its use in service provision, its source, and the means of its transfer, receipt and display.

Examples of Data Sources

Examples of data sources normally required are:

- AIS
- NOTAM
- Meteorological information
- Voice coordination
- Aerodrome works and administration coordination
- Local and remote radar data
- Information concerning volcanic activity
- AFTN
- Flight notification
- Meteorological warning service
- Information on aerodrome conditions and the operational status of facilities and navigation aids
- AES coordination
- Information concerning radioactive material and toxic chemical clouds.

(i) A description of the arrangements made by the applicant to ensure that it can, and will continue to be able to, provide the information in relation to its air traffic services to other organisations whose functions reasonably require that information (e.g. other ATS units and centres);

(j) The requirement for a record keeping system that covers identification, collection, storage, security, maintenance, access and disposal of records necessary for the provision of air traffic services. The record systems shall provide an accurate chronicle of ATS activities for the purpose of reconstruction of events for air safety investigation or for system safety analysis within the Safety Management System;

(k) A copy of any agreement entered into by the provider in relation to the provision of any of the air traffic services;

(l) A copy of the document that sets out the provider's safety management system;

(m) A description of the procedures to be followed to ensure all operational staff are familiar with any operational changes that have been issued since they last performed operational duties;

(n) A description of the provider’s training and checking program and provide assurance that any individual performing any functions in air traffic services is competent to perform that function;

(o) The processes for the preparation, authorization and issue of amendments to its operations manual.

16.7.3 The operations manual is an important document and shall be issued under the authority of the ANSP. The ANSP shall control the distribution of the operations manual and ensure that it is amended whenever necessary to maintain the accuracy of the information in the operations manual and to keep its contents up to date.

INTENTIONALLY LEFT BLANK

APPENDIX 1

INSTRUCTIONS FOR AIR-REPORTING BY VOICE COMMUNICATIONS

1. Reporting instructions
2. Special air-report of volcanic activity form (Model VAR)
3. Examples

1. Reporting instructions

MODEL AIREP SPECIAL

ITEM	PARAMETER	TRANSMIT IN TELEPHONY as appropriate
	Message-type designator: - special air-report	[AIREP] SPECIAL

Section 1	1	Aircraft identification	(aircraft identification)
	2	Position	POSITION (latitude and longitude) OVER (significant point) ABEAM (significant point) (significant point) (bearing) (distance)
	3	Time	(time)
	4	Level	FLIGHT LEVEL (number) or (number) METRES or FEET CLIMBING TO FLIGHT LEVEL (number) or (number) METRES or FEET DESCENDING TO FLIGHT LEVEL (number) or (number) METRES or FEET
	5	Next position and estimated time over	(position) (time)
	6	Ensuing significant point	(position) NEXT
Section 2	7	Estimated time of arrival	(aerodrome) (time)
	8	Endurance	ENDURANCE 9hours and minutes)
Section 3	9	Phenomenon encountered or observed prompting a special air-report: <ul style="list-style-type: none"> ▪ Moderate turbulence ▪ Severe turbulence ▪ Moderate icing ▪ Severe icing ▪ Severe mountainwave ▪ Thunderstorm without hail ▪ Thunderstorm with hail ▪ Heavy dust/sandstorm ▪ Volcanic ash cloud ▪ Pre-eruption volcanic activity or volcanic eruption 	TURBULENCE MODERATE TURBULENCE SEVERE ICING MODERATE ICING SEVERE MOUNTAINWAVE SEVERE THUNDERSTORMS THUNDERSTORMS WITH HAIL DUSTSTORM or SANDSTORM HEAVY VOLCANIC ASH CLOUD PRE-ERUPTION VOLCANIC ACTIVITY or VOLCANIC ERUPTION

1 Position reports and special air-reports

1.1 Section 1 is obligatory for position reports and special air reports, although Items 5 and 6 thereof may be omitted when prescribed in *Regional Supplementary Procedures*; Section 2 shall be added, in whole or in part, only when so requested by the operator or its designated representative, or when deemed necessary by the pilot-in-command; Section 3 shall be included in special air-reports.

2 Detailed reporting instructions

2.1 Items of an air-report shall be reported in the order in which they are listed in the model AIREP/AIREP SPECIAL form.

— MESSAGE TYPE DESIGNATOR. Report “SPECIAL” for a special air-report.

Section 1

Item 1 — AIRCRAFT IDENTIFICATION. Report the aircraft radiotelephony call sign as prescribed in Annex 10, Volume II, Chapter 5.

Item 2 — POSITION. Report position in latitude (degrees as 2 numerics or degrees and minutes as 4 numerics, followed by “North” or “South”) and longitude (degrees as 3 numerics or degrees and minutes as 5 numerics, followed by “East” or “West”), or as a significant point identified by a coded designator (2 to 5 characters), or as a significant point followed by magnetic bearing (3 numerics) and distance in nautical miles from the point (e.g. “4620North07805West”, “4620North07800West”, “4600North07800West”, LN (“LIMA NOVEMBER”), “MAY”, “HADDY” or “DUB 180 DEGREES 40 MILES”). Precede significant point by “ABEAM”, if applicable.

Item 3 — TIME. Report time in hours and minutes UTC (4 numerics) unless reporting time in minutes past the hour (2 numerics) is prescribed on the basis of regional air navigation agreements. The time reported must be the actual time of the aircraft at the position and not the time of origination or transmission of the report. Time shall always be reported in hours and minutes UTC when making a special air-report.

Item 4 — FLIGHT LEVEL OR ALTITUDE. Report flight level by 3 numerics (e.g. “FLIGHT LEVEL 310”), when on standard pressure altimeter setting. Report altitude in metres followed by “METRES” or in feet followed by “FEET”, when on QNH. Report “CLIMBING” (followed by the level) when climbing, or “DESCENDING” (followed by the level) when descending, to a new level after passing the significant point.

Item 5 — NEXT POSITION AND ESTIMATED TIME OVER. Report the next reporting point and the estimated time over such reporting point, or report the estimated position that will be reached one hour later, according to the position reporting procedures in force. Use the data conventions specified in Item 2 for position. Report the estimated time over this position. Report time in hours and minutes UTC (4 numerics) unless reporting time in minutes past the hour (2 numerics) as prescribed on the basis of regional air navigation agreements.

Item 6 — ENSUING SIGNIFICANT POINT. Report the ensuing significant point following the “next position and estimated time over”.

Section 2

Item 7 — ESTIMATED TIME OF ARRIVAL. Report the name of the aerodrome of the first intended landing, followed by the estimated time of arrival at this aerodrome in hours and minutes UTC (4 numerics).

Item 8 — ENDURANCE. Report “ENDURANCE” followed by fuel endurance in hours and minutes (4 numerics).

Section 3

Item 9 — PHENOMENON PROMPTING A SPECIAL AIR-REPORT. Report one of the following phenomena encountered or observed:

- moderate turbulence as “TURBULENCE MODERATE”
- severe turbulence as “TURBULENCE SEVERE”

The following specifications apply:

Moderate — Conditions in which moderate changes in aircraft attitude and/or altitude may occur but the aircraft remains in positive control at all times. Usually, small variations in airspeed. Changes in accelerometer readings of 0.5 g to 1.0 g at the aircraft’s centre of gravity. Difficulty in walking. Occupants feel strain against seat belts. Loose objects move about.

Severe — Conditions in which abrupt changes in aircraft attitude and/or altitude occur; aircraft may be out of control for short periods. Usually, large variations in airspeed. Changes in accelerometer readings greater than 1.0 g at the aircraft’s centre of gravity. Occupants are forced violently against seat belts. Loose objects are tossed about.

- moderate icing as “ICING MODERATE”
- severe icing as “ICING SEVERE”

The following specifications apply:

Moderate — Conditions in which change of heading and/or altitude may be considered desirable.

Severe — Conditions in which immediate change of heading and/or altitude is considered essential.

- severe mountainwave as “MOUNTAINWAVE SEVERE”

The following specification applies:

severe — conditions in which the accompanying downdraft is 3.0 m/s (600 ft/min) or more and/or severe turbulence is encountered.

- thunderstorm without hail as “THUNDERSTORM”
- thunderstorm with hail as “THUNDERSTORM WITH HAIL”

The following specification applies:

Only report those thunderstorms which are:

- obscured in haze; or
- embedded in cloud; or
- widespread; or
- forming a squall-line.

- heavy duststorm or sandstorm as “DUSTSTORM *or* SANDSTORM HEAVY”

- volcanic ash cloud as “VOLCANIC ASH CLOUD”
- pre-eruption volcanic activity or a volcanic eruption as “PRE-ERUPTION VOLCANIC ACTIVITY *or* VOLCANIC ERUPTION”

The following specifications apply:

Pre-eruption volcanic activity in this context means unusual and/or increasing volcanic activity which could presage a volcanic eruption.

Note.— In case of volcanic ash cloud, pre-eruption volcanic activity or volcanic eruption, in accordance with Chapter 4, 4.12.3, a post-flight report shall also be made on the special air-report of volcanic activity form (Model VAR).

3.2 Information recorded on the volcanic activity reporting form (Model VAR) is not for transmission by RTF but, on arrival at an aerodrome, is to be delivered without delay by the operator or a flight crew member to the aerodrome meteorological office. If such an office is not easily accessible, the completed form shall be delivered in accordance with local arrangements made between the meteorological and ATS units and the operator.

3 Forwarding of meteorological information received by voice communications

When receiving special air-reports, air traffic services units shall forward these air-reports without delay to the associated meteorological watch office (MWO). In order to ensure assimilation of air-reports in ground-based automated systems, the elements of such reports shall be transmitted using the data conventions specified below and in the order prescribed.

— ADDRESSEE. Record station called and, when necessary, relay required.

— MESSAGE TYPE DESIGNATOR. Record “ARS” for a special air-report.

Note.— Where air-reports are handled by automatic data processing equipment which cannot accept this message-type designator, in accordance with Chapter 11, 11.4.2.6.5.2, the use of a different message-type designator is permitted by regional air navigation agreement.

— AIRCRAFT IDENTIFICATION. Record the aircraft identification using the data convention specified for Item 7 of the flight plan, without a space between the operator’s designator and the aircraft registration or flight identification, if used (e.g. New Zealand 103 as ANZ103).

Section 1

Item 0 — POSITION. Record position in latitude (degrees as 2 numerics or degrees and minutes as 4 numerics, followed without a space by N or S) and longitude (degrees as 3 numerics or degrees and minutes as 5 numerics, followed without a space by E or W), or as a significant point identified by a coded designator (2 to 5 characters), or as a significant point followed by magnetic bearing (3 numerics) and distance in nautical miles (3 numerics) from the point (e.g. 4620N07805W, 4620N078W, 46N078W, LN, MAY, HADDY or DUB180040). Precede significant point by “ABM” (abeam), if applicable.

Item 1 — TIME. Record time in hours and minutes UTC (4 numerics).

Item 2 — FLIGHT LEVEL OR ALTITUDE. Record F followed by 3 numerics (e.g. F310), when a flight level is reported. Record altitude in metres followed by M or in feet followed by FT, when an altitude is reported. Record “ASC” (level) when climbing, or “DES” (level) when descending.

Section 3

Item 9 — PHENOMENON PROMPTING A SPECIAL AIR-REPORT. Record the phenomenon reported as follows:

- moderate turbulence as “TURB MOD”
- severe turbulence as “TURB SEV”
- moderate icing as “ICE MOD”
- severe icing as “ICE SEV”
- severe mountainwave as “MTW SEV”
- thunderstorm without hail as “TS”
- thunderstorm with hail as “TSGR”
- heavy duststorm or sandstorm as “HVY SS”
- volcanic ash cloud as “VA CLD”
- pre-eruption volcanic activity or a volcanic eruption as “VA”
- moderate turbulence as “TURB MOD”
- hail as “GR”
- cumulonimbus clouds as “CB”.

— TIME TRANSMITTED. Record only when Section 3 is transmitted.

2 Special air-report of volcanic activity form (Model VAR)

MODEL VAR: to be used for post-flight reporting

VOLCANIC ACTIVITY REPORT

Air-reports are critically important in assessing the hazards which volcanic ash cloud presents to aircraft operations.

OPERATOR:			A/C IDENTIFICATION: (as indicated on flight plan)		
PILOT-IN-COMMAND:					
DEP FROM:	DATE:	TIME, UTC:	ARR AT:	DATE:	TIME, UTC:
ADDRESSEE			AIREP SPECIAL		
Items 1-8 are to be reported immediately to the ATS unit that you are in contact with.					
1) AIRCRAFT IDENTIFICATION			2) POSITION		
3) TIME			4) FLIGHT LEVEL OR ALTITUDE		
5) VOLCANIC ACTIVITY OBSERVED AT (position or bearing, estimated level of ash cloud and distance from aircraft)					
6) AIR TEMPERATURE			7) SPOT WIND		
8) SUPPLEMENTARY INFORMATION			Other _____		
SO ₂ detected Yes <input type="checkbox"/> No <input type="checkbox"/>			_____		
Ash encountered Yes <input type="checkbox"/> No <input type="checkbox"/>			_____		
(Brief description of activity especially vertical and lateral extent of ash cloud and, where possible, horizontal movement, rate of growth, etc.)			(Brief description of activity especially vertical and lateral extent of ash cloud and, where possible, horizontal movement, rate of growth, etc.)		
After landing complete items 9-16 then fax form to: (Fax number to be provided by the meteorological authority based on local arrangements between the meteorological authority and the operator concerned.)					
9) DENSITY OF ASH CLOUD	<input type="checkbox"/> (a) Wispy	<input type="checkbox"/> (b) Moderate dense	<input type="checkbox"/> (c) Very dense		
10) COLOUR OF ASH CLOUD	<input type="checkbox"/> (a) White	<input type="checkbox"/> (b) Light grey	<input type="checkbox"/> (c) Dark grey		
	<input type="checkbox"/> (d) Black	<input type="checkbox"/> (e) Other _____			
11) ERUPTION	<input type="checkbox"/> (a) Continuous	<input type="checkbox"/> (b) Intermittent	<input type="checkbox"/> (c) Not visible		
12) POSITION OF ACTIVITY	<input type="checkbox"/> (a) Summit	<input type="checkbox"/> (b) Side	<input type="checkbox"/> (c) Single		
	<input type="checkbox"/> (d) Multiple	<input type="checkbox"/> (e) Not observed			
13) OTHER OBSERVED FEATURES OF ERUPTION	<input type="checkbox"/> (a) Lightning	<input type="checkbox"/> (b) Glow	<input type="checkbox"/> (c) Large rocks		
	<input type="checkbox"/> (d) Ash fallout	<input type="checkbox"/> (e) Mushroom cloud	<input type="checkbox"/> (f) All		
14) EFFECT ON AIRCRAFT	<input type="checkbox"/> (a) Communication	<input type="checkbox"/> (b) Navigation systems	<input type="checkbox"/> (c) Engines		
	<input type="checkbox"/> (d) Pitot static	<input type="checkbox"/> (e) Windscreen	<input type="checkbox"/> (f) Windows		
	<input checked="" type="checkbox"/> (g) All				
15) OTHER EFFECTS	<input type="checkbox"/> (a) Turbulence	<input type="checkbox"/> (b) St. Elmo's Fire	<input type="checkbox"/> (c) Other fumes		
	<input checked="" type="checkbox"/> (d) Ash deposits				
16) OTHER INFORMATION (Any information considered useful.)					

3 Examples

AS SPOKEN IN RADIOTELEPHONY	AS RECORDED BY THE AIR TRAFFIC SERVICES UNIT AND FORWARDED TO THE METEOROLOGICAL OFFICE CONCERNED
I. ¹ AIREP SPECIAL CLIPPER WUN ZERO WUN POSITION FIFE ZERO FOW _{er} FIFE NORTH ZERO TOO ZERO WUN FIFE WEST WUN FIFE TREE SIX FLIGHT LEVEL TREE WUN ZERO CLIMBING TO FLIGHT LEVEL TREE FIFE ZERO THUNDERSTORMS WITH HAIL	I.- ARS PAA101 5045N02015W 1536 F310 ASC F350 TSGR
II. ² SPECIAL NIUGINI TOO SEV _{en} TREE OVER MADANG ZERO AIT FOW _{er} SIX WUN NIN _{er} TOUSAND FEET TURBULENCE SEVERE	IV.- ARS ANG273 MD 0846 19000FT TURB SEV

¹ A special air-report which is required because of the occurrence of widespread thunderstorms with hail.

² A special air-report which is required because of severe turbulence. The aircraft is on QNH altimeter setting.

APPENDIX 2

FLIGHT PLAN

1. ICAO model flight plan form
2. Instructions for the completion of the flight plan form
3. Instructions for the transmission of a filed flight plan (FPL) message
4. Instructions for the transmission of a supplementary flight plan (SPL) message
5. Example of a completed flight plan form
6. ICAO model repetitive flight plan (RPL) listing form
7. Instructions for the completion of the repetitive flight plan (RPL) listing form
8. Example of a completed repetitive flight plan (RPL) listing form

1 ICAO model flight plan form

FLIGHT PLAN PLAN DE VOL			
PRIORITY Priorité <<<= FF →	ADDRESSEE(S) Destinataire(s)		
FILING TIME Heure de dépôt	ORIGINATOR Expéditeur		
SPECIFIC IDENTIFICATION OF ADDRESSEE(S) AND/OR ORIGINATOR Identification précise du(des) destinataire(s) et/ou de l'expéditeur			
3 MESSAGE TYPE Type de message <<<= (FPL)	7 AIRCRAFT IDENTIFICATION Identification de l'aéronef	8 FLIGHT RULES Règles de vol	TYPE OF FLIGHT Type de vol
9 NUMBER Nombre	TYPE OF AIRCRAFT Type d'aéronef	WAKE TURBULENCE CAT. Cat. de turbulence de sillage	10 EQUIPMENT Équipement
13 DEPARTURE AERODROME Aérodrome de départ	TIME Heure	15 CRUISING SPEED Vitesse croisière	
LEVEL Niveau		ROUTE Route	
16 DESTINATION AERODROME Aérodrome de destination			
TOTAL EET Durée totale estimée HR MIN		ALTN AERODROME Aérodrome de dégagement	2ND ALTN AERODROME 2 ^e aérodrome de dégagement
18 OTHER INFORMATION Renseignements divers			
SUPPLEMENTARY INFORMATION (NOT TO BE TRANSMITTED IN FPL MESSAGES) Renseignements complémentaires (À NE PAS TRANSMETTRE DANS LES MESSAGES DE PLAN DE VOL DÉPOSÉ)			
19 ENDURANCE Autonomie HR MIN	PERSONS ON BOARD Personnes à bord	EMERGENCY RADIO Radio de secours	
SURVIVAL EQUIPMENT/Équipement de survie	JACKETS/Gilets de sauvetage	UHF	VHF
POLAR Polaire	DESERT Désert	LIGHT Lampes	ELT
MARITIME Maritime	JUNGLE Jungle	FLUORES Fluores	UHF
DINGHIES/Canots	NUMBER Nombre	UHF	VHF
CAPACITY Capacité	COVER Couverture	COLOUR Couleur	
AIRCRAFT COLOUR AND MARKINGS Couleur et marques de l'aéronef	REMARKS Remarques		
PILOT-IN-COMMAND Pilote commandant de bord	FILED BY / Déposé par		
SPACE RESERVED FOR ADDITIONAL REQUIREMENTS Espace réservé à des fins supplémentaires)<<<=	

2 Instructions for the completion of the flight plan form

2.1 General

Adhere closely to the prescribed formats and manner of specifying data.

Commence inserting data in the first space provided. Where excess space is available, leave unused spaces blank.

Insert all clock times in 4 figures UTC.

Insert all estimated elapsed times in 4 figures (hours and minutes).

Shaded area preceding Item 3 — to be completed by ATS and COM services, unless the responsibility for originating flight plan messages has been delegated.

Note.— The term “aerodrome” where used in the flight plan is intended to cover also sites other than aerodromes which may be used by certain types of aircraft, e.g. helicopters or balloons.

2.2 Instructions for insertion of ATS data

Complete Items 7 to 18 as indicated hereunder.

Complete also Item 19 as indicated hereunder, when so required by the appropriate ATS unit or when otherwise deemed necessary.

Note.— Item numbers on the form are not consecutive, as they correspond to Field Type numbers in ATS messages.

<p style="text-align: center;">ITEM 7: AIRCRAFT IDENTIFICATION (MAXIMUM 7 CHARACTERS)</p>
--

INSERT one of the following aircraft identifications, not exceeding 7 characters:

a) the registration marking of the aircraft (e.g. EIAKO, 4XBCD, N2567GA), when:

1) in radiotelephony the call sign to be used by the aircraft will consist of this identification alone (e.g. OOTEK), or preceded by the ICAO telephony designator for the aircraft operating agency (e.g. SABENA OOTEK);

2) the aircraft is not equipped with radio; *OR*

b) the ICAO designator for the aircraft operating agency followed by the flight identification (e.g. KLM511, NGA213, JTR25) when in radiotelephony the call sign to be used by the aircraft will consist of the ICAO telephony designator for the operating agency followed by the flight identification (e.g. KLM511, NIGERIA 213, HERBIE 25).

Note.— Provisions for the use of radiotelephony call signs are contained in Annex 10, Volume II, Chapter 5. ICAO designators and telephony designators for aircraft operating agencies are contained in Doc 8585 — Designators for Aircraft Operating Agencies, Aeronautical Authorities and Services.

ITEM 8: FLIGHT RULES AND TYPE OF FLIGHT (ONE OR TWO CHARACTERS)

Flight rules

INSERT one of the following letters to denote the category of flight rules with which the pilot intends to comply:

- I if IFR
- V if VFR
- Y if IFR first) and specify in Item 15 the point or
- Z if VFR first) points where a change of flight rules is planned.

Type of flight

INSERT one of the following letters to denote the type of flight when so required by the appropriate ATS unit:

- S if scheduled air service
- N if non-scheduled air transport operation
- G if general aviation
- M if military
- X if other than any of the defined categories above.

**ITEM 9: NUMBER AND TYPE OF AIRCRAFT
AND WAKE TURBULENCE CATEGORY**

Number of aircraft (1 or 2 characters)

INSERT the number of aircraft, if more than one.

Type of aircraft (2 to 4 characters)

INSERT the appropriate designator as specified in ICAO Doc 8643, *Aircraft Type Designators*,*OR*, if no such designator has been assigned, or in case of formation flights comprising more than one type,*INSERT* *ZZZZ*, and *SPECIFY* in Item 18, the (numbers and) type(s) of aircraft preceded by TYP/.

Wake turbulence category (1 character)

INSERT an oblique stroke followed by one of the following letters to indicate the wake turbulence category of the aircraft:

H — HEAVY, to indicate an aircraft type with a maximum certificated take-off mass of 136 000 kg or more;

M — MEDIUM, to indicate an aircraft type with a maximum certificated take-off mass of less than 136 000 kg but more than 7 000 kg;

L — LIGHT, to indicate an aircraft type with a maximum certificated take-off mass of 7 000 kg or less.

ITEM 10: EQUIPMENT

Radiocommunication, navigation and approach aid equipment

INSERT one letter as follows:

N if no COM/NAV/approach aid equipment for the route to be flown is carried, or the equipment is unserviceable,

OR S if standard COM/NAV/approach aid equipment for the route to be flown is carried and serviceable (*see Note 1*),

AND/OR

INSERT one or more of the following letters to indicate the COM/NAV/approach aid equipment available and serviceable:

A	(Not allocated)	M	Omega
B	(Not allocated)	O	VOR
C	LORAN C	P	(Not allocated)
D	DME	Q	(Not allocated)
E	(Not allocated)	R	RNP type certification
F	ADF		(<i>see Note 5</i>)
G	(GNSS)	T	TACAN
H	HF RTF	U	UHF RTF
I	Inertial navigation	V	VHF RTF
J	(Data link)	W	} When prescribed by ATS
	(<i>see Note 3</i>)	X	
		Y	
K	(MLS)		
L	ILS	Z	Other equipment carried
			(<i>see Note 2</i>).

Note 1.— Standard equipment is considered to be VHF RTF, ADF, VOR and ILS, unless another combination is prescribed by the appropriate ATS authority.

Note 2.— If the letter Z is used, specify in Item 18 the other equipment carried, preceded by COM/ and/or NAV/, as appropriate.

Note 3.— If the letter J is used, specify in Item 18 the equipment carried, preceded by DAT/ followed by one or more letters as appropriate.

Note 4.— Information on navigation capability is provided to ATC for clearance and routing purposes.

Note 5.— Inclusion of letter R indicates that an aircraft meets the RNP type prescribed for the route segment(s), route(s) and/or area concerned.

Surveillance equipment

INSERT one or two of the following letters to describe the serviceable surveillance equipment carried:

SSR equipment

- N Nil
- A Transponder — Mode A (4 digits — 4 096 codes)
- C Transponder — Mode A (4 digits — 4 096 codes) and Mode C
- X Transponder — Mode S without both aircraft identification and pressure-altitude transmission
- P Transponder — Mode S, including pressure-altitude transmission, but no aircraft identification transmission
- I Transponder — Mode S, including aircraft identification transmission, but no pressure-altitude transmission
- S Transponder — Mode S, including both pressure-altitude and aircraft identification transmission.

ADS equipment

- D ADS capability

**ITEM 13: DEPARTURE AERODROME
AND TIME (8 CHARACTERS)**

INSERT the ICAO four-letter location indicator of the departure aerodrome,

OR if no location indicator has been assigned,

INSERT ZZZZ and *SPECIFY*, in Item 18, the name of the aerodrome preceded by DEP/ ,

OR, if the flight plan is received from an aircraft in flight,

INSERT AFIL, and *SPECIFY*, in Item 18, the ICAO four-letter location indicator of the location of the ATS unit from which supplementary flight plan data can be obtained, preceded by DEP/ .

THEN, WITHOUT A SPACE,

INSERT for a flight plan submitted before departure, the estimated off-block time,

OR, for a flight plan received from an aircraft in flight, the actual or estimated time over the first point of the route to which the flight plan applies.

ITEM 15: ROUTE

INSERT the *first cruising speed* as in (a) and the *first cruising level* as in (b), without a space between them.

THEN, following the arrow, *INSERT* the route description as in (c).

(a) Cruising speed (maximum 5 characters)

INSERT the *True airspeed* for the first or the whole cruising portion of the flight, in terms of:

Kilometres per hour, expressed as K followed by 4 figures (e.g. K0830), *or*

Knots, expressed as N followed by 4 figures (e.g. N0485), *or*

True Mach number, when so prescribed by the appropriate ATS unit, to the nearest hundredth of unit Mach, expressed as M followed by 3 figures (e.g. M082).

(b) Cruising level (maximum 5 characters)

INSERT the planned cruising level for the first or the whole portion of the route to be flown, in terms of:

Flight level, expressed as F followed by 3 figures (e.g. F085; F330), *or*

**Standard metric level in tens of metres*, expressed as S followed by 4 figures (e.g. S1130), *or*

Altitude in hundreds of feet, expressed as A followed by 3 figures (e.g. A045; A100), *or*

Altitude in tens of metres, expressed as M followed by 4 figures (e.g. 0840), *or*

for uncontrolled VFR flights, the letters VFR.

(c) Route (including changes of speed, level and/or flight rules)

Flights along designated ATS routes

INSERT, if the departure aerodrome is located on or connected to the ATS route, the designator of the first ATS route,

OR if the departure aerodrome is not on or connected to the ATS route, the letters DCT followed by the point of joining the first ATS route, followed by the designator of the ATS route.

THEN

INSERT each point at which either a change of speed or level, a change of ATS route, and/or a change of flight rules is planned,

Note.— When a transition is planned between a lower and upper ATS route and the routes are oriented in the same direction, the point of transition need not be inserted.

FOLLOWED IN EACH CASE

by the designator of the next ATS route segment, even if the same as the previous one,

OR by DCT, if the flight to the next point will be outside a designated route, unless both points are defined by geographical coordinates.

* When so prescribed by the appropriate ATS units.

Flights outside designated ATS routes

INSERT points normally not more than 30 minutes flying time or 370 km (200 NM) apart, including each point at which a change of speed or level, a change of track, or a change of flight rules is planned.

OR when required by appropriate ATS unit(s),

DEFINE the track of flights operating predominantly in an east-west direction between 70°N and 70°S by reference to significant points formed by the intersections of half or whole degrees of latitude with meridians spaced at intervals of 10 degrees of longitude. For flights operating in areas outside those latitudes the tracks shall be defined by significant points formed by the intersection of parallels of latitude with meridians normally spaced at 20 degrees of longitude. The distance between significant points shall, as far as possible, not exceed one hour's flight time. Additional significant points shall be established as deemed necessary.

For flights operating predominantly in a north-south direction, define tracks by reference to significant points formed by the intersection of whole degrees of longitude with specified parallels of latitude which are spaced at 5 degrees.

INSERT DCT between successive points unless both points are defined by geographical coordinates or by bearing and distance.

USE ONLY the conventions in (1) to (5) below and *SEPARATE* each sub-item by a space.

(1)

ATS route (2 to 7 characters)

The coded designator assigned to the route or route segment including, where appropriate, the coded designator assigned to the standard departure or arrival route (e.g. BCN1, B1, R14, UB10, KODAP2A).

Note.— Provisions for the application of route designators are contained in Annex 11, Appendix 1, while guidance material on the application of an RNP type to a specific route segment(s), route(s) or area is contained in the Performance-based Navigation Manual (Doc 9613).

(2) Significant point (2 to 11 characters)

The coded designator (2 to 5 characters) assigned to the point (e.g. LN, MAY, HADDY),

or, if no coded designator has been assigned, one of the following ways:

— *Degrees only* (7 characters):

2 figures describing latitude in degrees, followed by “N” (North) or “S” (South), followed by 3 figures describing longitude in degrees, followed by “E” (East) or “W” (West). Make up the correct number of figures, where necessary, by insertion of zeros, e.g. 46N078W.

— *Degrees and minutes* (11 characters):

4 figures describing latitude in degrees and tens and units of minutes followed by “N” (North) or “S” (South), followed by 5 figures describing longitude in degrees and tens and units of minutes, followed by “E” (East) or “W” (West). Make up the correct number of figures, where necessary, by insertion of zeros, e.g. 4620N07805W.

— *Bearing and distance from a navigation aid*:

The identification of the navigation aid (normally a VOR), in the form of 2 or 3 characters, THEN the bearing from the aid in the form of 3 figures giving degrees magnetic, THEN the distance from the aid in the form of 3 figures expressing nautical miles. Make up the correct number of figures, where necessary, by insertion of zeros — e.g. a point 180° magnetic at a distance of 40 nautical miles from VOR “DUB” should be expressed as DUB180040.

(3) Change of speed or level
(maximum 21 characters)

The point at which a change of speed (5% TAS or 0.01 Mach or more) or a change of level is planned, expressed exactly as in (2) above, followed by an *oblique stroke and both the cruising speed and the cruising level*, expressed exactly as in (a) and (b) above, without a space between them, *even when only one of these quantities will be changed*.

Examples: LN/N0284A045
MAY/N0305F180
HADDY/N0420F330
4602N07805W/N0500F350
46N078W/M082F330
DUB180040/N0350M0840

- (4)

Change of flight rules (maximum 3 characters)
--

The point at which the change of flight rules is planned, expressed exactly as in (2) or (3) above as appropriate, followed by a space and one of the following:

VFR if from IFR to VFR

IFR if from VFR to IFR

Examples: LN VFR
 LN/N0284A050 IFR

- (5)

Cruise climb (maximum 28 characters)

The letter C followed by an oblique stroke; THEN the point at which cruise climb is planned to start, expressed exactly as in (2) above, followed by an oblique stroke; THEN the speed to be maintained during cruise climb, expressed exactly as in (a) above, followed by the two levels defining the layer to be occupied during cruise climb, each level expressed exactly as in (b) above, or the level above which cruise climb is planned followed by the letters PLUS, without a space between them.

Examples: C/48N050W/M082F290F350
 C/48N050W/M082F290PLUS
 C/52N050W/M220F580F620.

**ITEM 16: DESTINATION AERODROME AND
TOTAL ESTIMATED ELAPSED TIME,
ALTERNATE AERODROME(S)**

Destination aerodrome and total
estimated elapsed time (8 characters)

INSERT the ICAO four-letter location indicator of the destination aerodrome followed, without a space, by the total estimated elapsed time,

OR if no location indicator has been assigned,

INSERT ZZZZ followed, without a space, by the total estimated elapsed time, and *SPECIFY* in Item 18 the name of the aerodrome, preceded by DEST/ .

Note.— For a flight plan received from an aircraft in flight, the total estimated elapsed time is the estimated time from the first point of the route to which the flight plan applies.

Alternate aerodrome(s) (4 characters)

INSERT the ICAO four-letter location indicator(s) of not more than two alternate aerodromes, separated by a space,

OR, if no location indicator has been assigned to the alternate aerodrome,

INSERT ZZZZ and *SPECIFY* in Item 18 the name of the aerodrome, preceded by ALTN/ .

ITEM 18: OTHER INFORMATION

INSERT 0 (zero) if no other information,

OR, any other necessary information in the preferred sequence shown hereunder, in the form of the appropriate indicator followed by an oblique stroke and the information to be recorded:

EET/ Significant points or FIR boundary designators and accumulated estimated elapsed times to such points or FIR boundaries, when so prescribed on the basis of regional air navigation agreements, or by the appropriate ATS unit.

Examples: EET/CAP0745 XYZ0830
EET/EINN0204

RIF/ The route details to the revised destination aerodrome, followed by the ICAO four-letter location indicator of the aerodrome. The revised route is subject to re-clearance in flight.

Examples: RIF/DTA HEC KLAX
RIF/ESP G94 CLA YPPH
RIF/LEMD

REG/ The registration markings of the aircraft, if different from the aircraft identification in Item 7.

SEL/ SELCAL code, if so prescribed by the appropriate ATS unit.

OPR/ Name of the operator, if not obvious from the aircraft identification in Item 7.

STS/ Reason for special handling by ATS, e.g. hospital aircraft, one engine inoperative, e.g. STS/HOSP, STS/ONE ENG INOP.

TYP/ Type(s) of aircraft, preceded if necessary by number(s) of aircraft, if *ZZZZ* is inserted in Item 9.

PER/ Aircraft performance data, if so prescribed by the appropriate ATS unit.

COM/ Significant data related to communication equipment as required by the appropriate ATS unit, e.g. COM/UHF only.

DAT/ Significant data related to data link capability, using one or more of the letters S, H, V and M, e.g. DAT/S for satellite data link, DAT/H for HF data link, DAT/V for VHF data link, DAT/M for SSR Mode S data link.

NAV/ Significant data related to navigation equipment as required by the appropriate ATS unit.

- DEP/ Name of departure aerodrome, if *ZZZZ* is inserted in Item 13, or the ICAO four-letter location indicator of the location of the ATS unit from which supplementary flight plan data can be obtained, if *AFIL* is inserted in Item 13.
- DEST/ Name of destination aerodrome, if *ZZZZ* is inserted in Item 16.
- ALTN/ Name of destination alternate aerodrome(s), if *ZZZZ* is inserted in Item 16.
- RALT/ Name of en-route alternate aerodrome(s).
- CODE/ Aircraft address (expressed in the form of an alphanumeric code of six hexadecimal characters) when required by the appropriate ATS unit.
Example: “F00001” is the lowest aircraft address contained in the specific block administered by ICAO.
- RMK/ Any other plain-language remarks when required by the appropriate ATS unit or deemed necessary.

ITEM 19: SUPPLEMENTARY INFORMATION**Endurance**

After E/ *INSERT* a 4-figure group giving the fuel endurance in hours and minutes.

Persons on board

After P/ *INSERT* the total number of persons (passengers and crew) on board, when required by the appropriate ATS unit. *INSERT* TBN (to be notified) if the total number of persons is not known at the time of filing.

Emergency and survival equipment

R/ (RADIO) *CROSS OUT* U if UHF on frequency 243.0 MHz is not available.
CROSS OUT V if VHF on frequency 121.5 MHz is not available.
CROSS OUT E if emergency locator transmitter (ELT) is not available.

- S/ (SURVIVAL EQUIPMENT) *CROSS OUT* all indicators if survival equipment is not carried. *CROSS OUT P* if polar survival equipment is not carried. *CROSS OUT D* if desert survival equipment is not carried. *CROSS OUT M* if maritime survival equipment is not carried. *CROSS OUT J* if jungle survival equipment is not carried.
- J/ (JACKETS) *CROSS OUT* all indicators if life jackets are not carried. *CROSS OUT L* if life jackets are not equipped with lights. *CROSS OUT F* if life jackets are not equipped with fluorescein. *CROSS OUT U* or *V* or both as in R/ above to indicate radio capability of jackets, if any.
- D/ (DINGHIES)
(NUMBER) *CROSS OUT* indicators D and C if no dinghies are carried, or *INSERT* number of dinghies carried; and
- (CAPACITY) *INSERT* total capacity, in persons, of all dinghies carried; and
- (COVER) *CROSS OUT* indicator C if dinghies are not covered; and
- (COLOUR) *INSERT* colour of dinghies if carried.
- A/ (AIRCRAFT COLOUR AND MARKINGS) *INSERT* colour of aircraft and significant markings.
- N/ (REMARKS) *CROSS OUT* indicator N if no remarks, or *INDICATE* any other survival equipment carried and any other remarks regarding survival equipment.
- C/ (PILOT) *INSERT* name of pilot-in-command.

2.3 Filed by

INSERT the name of the unit, agency or person filing the flight plan.

2.4 Acceptance of the flight plan

Indicate acceptance of the flight plan in the manner prescribed by the appropriate ATS unit.

2.5 Instructions for insertion of COM data

Items to be completed

COMPLETE the top two shaded lines of the form, and *COMPLETE* the third shaded line only when necessary, in accordance with the provisions in PANS-ATM, Chapter 11, 11.2.1.2, unless ATS prescribes otherwise.

3 Instructions for the transmission of a filed flight plan (FPL) message

Correction of obvious errors

Unless otherwise prescribed, *CORRECT* obvious format errors and/or omissions (i.e. oblique strokes) to ensure adherence as specified in Section 2.

Items to be transmitted

TRANSMIT items as indicated hereunder, unless otherwise prescribed:

a) the items in the shaded lines, above Item 3;

b) commencing with <<≡ (FPL of Item 3:

all symbols and data in the unshaded boxes down to the)<<≡ at the end of Item 18,

additional alignment functions as necessary to prevent the inclusion of more than 69 characters in any line of Items 15 or 18. The alignment function is to be inserted only in lieu of a space so as not to break up a group of data,

letter shifts and figure shifts (not preprinted on the form) as necessary;

c) the AFTN Ending, as described below:

End-of-Text Signal

a) one LETTER SHIFT

b) two CARRIAGE RETURNS, one LINE FEED

Page-feed Sequence

Seven LINE FEEDS

End-of-Message Signal

Four of the letter N.

4 Instructions for the transmission of a supplementary flight plan (SPL) message

Items to be transmitted

Transmit items as indicated hereunder, unless otherwise prescribed:

a) AFTN Priority Indicator, Addressee Indicators <<≡, Filing Time, Originator Indicator <<≡ and, if necessary, specific identification of addressees and/or originator;

b) commencing with <<≡ (SPL:

all symbols and data in the unshaded areas of boxes 7, 16 and 18, except that the ‘)’ at the end of box 18 is *not* to be transmitted, and then the symbols in the unshaded area of box 19 down to and including the)<<≡ of box 19,

additional alignment functions as necessary to prevent the inclusion of more than 69 characters in any line of Items 18 and 19. The alignment function is to be inserted only in lieu of a space so as not to break up a group of data,

letter shifts and figure shifts (not preprinted on the form) as necessary;

c) the AFTN Ending, as described below:

End-of-Text Signal

a) one LETTER SHIFT

b) two CARRIAGE RETURNS, one LINE FEED

Page-feed Sequence

Seven LINE FEEDS

End-of-Message Signal

Four of the letter N.

5 Example of a completed flight plan form

FLIGHT PLAN PLAN DE VOL			
PRIORITY Priorité <<≡ FF →	ADDRESSEE(S) Destinataire(s) EHAA ZQZX EBURZQZX EDDYZQZX LFFFZQZX LFRR ZQZX LFBBZQZX LECMZQZX LPPCZQZX		
FILING TIME Heure de dépôt 1 9 0 8 3 6 →	ORIGINATOR Expéditeur E H A M Z P Z X <<≡		
SPECIFIC IDENTIFICATION OF ADDRESSEE(S) AND/OR ORIGINATOR Identification précise du(des) destinataire(s) et/ou de l'expéditeur			
3 MESSAGE TYPE Type de message <<≡ (FPL	7 AIRCRAFT IDENTIFICATION Identification de l'aéronef A C F 4 0 2	8 FLIGHT RULES Règles de vol I	TYPE OF FLIGHT Type de vol N <<≡
9 NUMBER Nombre []	TYPE OF AIRCRAFT Type d'aéronef E A 3 0	WAKE TURBULENCE CAT. Cat. de turbulence de sillage I H	10 EQUIPMENT Équipement S I C <<≡
13 DEPARTURE AERODROME Aérodrome de départ E H A M	TIME Heure 0 9 4 0 <<≡		
15 CRUISING SPEED Vitesse croisière K 0 8 3 0	LEVEL Niveau F 2 9 0	ROUTE Route LEK2B LEK UA6 XMM/MO78 F330	
UA6 PON URION CHW UA5 NTS DCT 4611N00412W DCT STG UA5 FTM FATIMIA			
<<≡			
16 DESTINATION AERODROME Aérodrome de destination L P P T	TOTAL EET Durée totale estimée HR MIN 0 2 3 0	ALTN AERODROME Aérodrome de décollage L P P R	2ND ALTN AERODROME 2 ^e aérodrome de décollage [] <<≡
18 OTHER INFORMATION Renseignements divers REG / FBVGA SEL / EJFL EET / LPPC0158			
>><<≡			
SUPPLEMENTARY INFORMATION (NOT TO BE TRANSMITTED IN FPL MESSAGES) Renseignements complémentaires (À NE PAS TRANSMETTRE DANS LES MESSAGES DE PLAN DE VOL DÉPOSÉ)			
19 ENDURANCE Autonomie HR MIN E / 0 3 4 5	PERSONS ON BOARD Personnes à bord P / 3 0 0	EMERGENCY RADIO Radio de secours UHF VHF ELT R / U V E	
SURVIVAL EQUIPMENT/Équipement de survie POLAR <input checked="" type="checkbox"/> / <input checked="" type="checkbox"/> DESERT <input checked="" type="checkbox"/> MARITIME <input checked="" type="checkbox"/> JUNGLE <input checked="" type="checkbox"/> DINGHIES/Canots <input checked="" type="checkbox"/>		JACKETS/Gilets de sauvetage LIGHT LAMPES <input checked="" type="checkbox"/> FLUORES <input checked="" type="checkbox"/> UHF <input checked="" type="checkbox"/> VHF <input checked="" type="checkbox"/>	
NUMBER Nombre D / 1 1	CAPACITY Capacité 3 3 0	COVER Couverture C →	COLOUR Couleur YELLOW <<≡
AIRCRAFT COLOUR AND MARKINGS Couleur et marques de l'aéronef A / WHITE			
REMARKS Remarques N / [] <<≡			
PILOT-IN-COMMAND Pilote commandant de bord C / DENKE >><<≡			
FILED BY / Déposé par			
AIR CHARTER INT.		SPACE RESERVED FOR ADDITIONAL REQUIREMENTS Espace réservé à des fins supplémentaires	

7 Instructions for the completion of the repetitive flight plan (RPL) listing form

7.1 General

List only flight plans that will operate in accordance with IFR. (Flight rules I in FPL format).

It is assumed that all aircraft are operating as scheduled flights (Type of flight S in FPL format), otherwise *notify* in Q (Remarks).

It is assumed that all aircraft operating on RPLs are equipped with 4 096-code transponders with Modes A and C. Otherwise, *notify* in Q (Remarks).

List flight plans in *alphabetical order of the location indicator of the departure aerodrome*.

List flight plans for each departure aerodrome in chronological order of estimated off-block times.

Adhere closely to the data conventions as indicated for the Flight Plan Form (**Appendix 3**, 1.6) unless otherwise specifically indicated in 7.4.

Insert all clock times in 4 figures UTC.

Insert all estimated elapsed times in 4 figures (hours and minutes).

Insert data on a separate line for each segment of operations with one or more stops, i.e. from any departure aerodrome to the next destination aerodrome even though call sign or flight number is the same for multiple segments.

Clearly identify additions and deletions in accordance with Item H at 7.4. Subsequent listings shall list the corrected and added data, and deleted flight plans shall be omitted.

Number pages by indicating number of page and total number of pages in submission.

Utilize more than one line for any RPL where the space provided for items O and Q on one line is not sufficient.

7.2 A flight shall be cancelled as follows:

- a) indicate a minus sign in Item H followed by all other items of the cancelled flight;
- b) insert a subsequent entry denoted by a plus sign in Item H and the date of the last flight in Item J, with all other items of the cancelled flight unchanged.

7.3 Modification to a flight shall be made as follows:

- a) carry out the cancellation as indicated in 7.2; and
- b) insert a third entry giving the new flight plan(s) with the appropriate items modified as necessary, including the new validity dates in Items I and J.

Note.— All entries related to the same flight will be inserted in succession in the order specified above.

7.4 Instructions for insertion of RPL data

Complete Items A to Q as indicated hereunder.

ITEM A: OPERATOR

INSERT name of operator.

ITEM B: ADDRESSEE(S)

INSERT name of agency(ies) designated by States to administer RPLs for FIRs or areas of responsibility concerned with the route of flight.

ITEM C: DEPARTURE AERODROME(S)

INSERT location indicator(s) of departure aerodrome(s).

ITEM D: DATE

INSERT on each page of submission the date (year, month, day) in a 6-figure group that the listing was submitted.

ITEM E: SERIAL NO.

INSERT serial number of submission (2 numerics) indicating last two digits of year, a dash, and the sequential no. of the submission for the year indicated (start with numeral 1 each new year).

ITEM F: PAGE OF

INSERT page number and total number of pages submitted.

ITEM G: SUPPLEMENTARY DATA AT

INSERT name of contact where information normally provided under Item 19 of the FPL is kept readily available and can be supplied without delay.

ITEM H: ENTRY TYPE

INSERT a minus sign (-) for each flight plan that is to be deleted from the listing.

INSERT a plus sign (+) for each initial listing and, in the case of subsequent submissions, for each flight plan not listed in the previous submission.

Note.— No information is required under this item for any flight plan which is unchanged from the previous submission.

ITEM I: VALID FROM

INSERT first date (year, month, day) upon which the flight is scheduled to operate.

ITEM J: VALID UNTIL

INSERT last date (year, month, day) upon which the flight is scheduled to operate as listed, or
UFN if the duration is unknown.

ITEM K: DAYS OF OPERATION

INSERT number corresponding to the day of the week in the appropriate column;
Monday = 1 through Sunday = 7.

INSERT 0 for each day of non-operation in the appropriate column.

ITEM L: AIRCRAFT IDENTIFICATION

(Item 7 of the ICAO flight plan)

INSERT aircraft identification to be used for the flight.

**ITEM M: TYPE OF AIRCRAFT AND
WAKE TURBULENCE CATEGORY**

(Item 9 of the ICAO flight plan)

INSERT appropriate ICAO designator as specified in ICAO Doc 8643 — *Aircraft Type Designators*.

INSERT H, M or L indicator as appropriate:

H — HEAVY to indicate an aircraft type with a maximum certificated take-off mass of 136 000 kg or more,

M — MEDIUM to indicate an aircraft type with a maximum certificated take-off mass of less than 136 000 kg but more than 7 000 kg,

L — LIGHT to indicate an aircraft type with a maximum certificated take-off mass of 7 000 kg or less.

ITEM N: DEPARTURE AERODROME AND TIME

(Item 13 of the ICAO flight plan)

INSERT location indicator of the departure aerodrome.*INSERT* the off-block time, i.e. the estimated time that the aircraft will commence movement associated with departure.**ITEM O: ROUTE**

(Item 15 of the ICAO flight plan)

(a) Cruising speed

INSERT the true airspeed for the first or whole cruising portion of the flight in accordance with Item 15 (a) of the ICAO flight plan.

(b) Cruising level

INSERT the planned cruising level for the first or whole portion of the route in accordance with Item 15 (b) of the ICAO flight plan.

(c) Route

INSERT the entire route in accordance with Item 15 (c) of the ICAO flight plan.**ITEM P: DESTINATION AERODROME AND
TOTAL ESTIMATED ELAPSED TIME**

(Item 16 of the ICAO flight plan)

INSERT location indicator of the destination aerodrome.*INSERT* the total estimated elapsed time.**ITEM Q: REMARKS***INSERT* items of information as required by the appropriate ATS authority, items normally notified in Item 18 of the ICAO flight plan and any other information pertinent to the flight of concern to ATS.

APPENDIX 3

AIR TRAFFIC SERVICES MESSAGES

1. Message contents, formats and data conventions
2. Examples of ATS messages

1 Message contents, formats and data conventions

Note.— To facilitate description of the content and format of air traffic services messages, both for interchange between units without automatic data processing equipment and for interchange between air traffic control computers, the elements of data to be included in the message are grouped into “fields”. Each field contains a single element or a group of related elements.

1.1 The standard types of message

The standard types of message established for the interchange of ATS data, together with the associated message type designators, are as follows:

<i>Message category</i>	<i>Message type</i>	<i>Message type designator</i>
Emergency	Alerting Radiocommunication failure	ALR RCF
Filed flight plan and associated update	Filed flight plan Modification Cancellation Delay Departure Arrival	FPL CHG CNL DLA DEP ARR
Coordination	Current flight plan Estimate Coordination Acceptance Logical acknowledgement	CPL EST CDN ACP LAM
Supplementary	Request flight plan Request supplementary flight plan Supplementary flight plan	RQP RQS SPL

1.2 The standard types of field

The standard fields of data permitted in ATS messages are as shown in the following table. The numbers in column 1 correspond with those in the reference table on page A3-31.

<i>Field type</i>	<i>Data</i>
3	Message type, number and reference data
5	Description of emergency
7	Aircraft identification and SSR mode and code
8	Flight rules and type of flight
9	Number and type of aircraft and wake turbulence category
10	Equipment
13	Departure aerodrome and time
14	Estimate data
15	Route
16	Destination aerodrome and total estimated elapsed time, alternate aerodrome(s)
17	Arrival aerodrome and time
18	Other information
19	Supplementary information
20	Alerting search and rescue information
21	Radio failure information
22	Amendment

1.3 Composition of the standard types of message

The composition of each standard type of message, expressed as a standardized sequence of fields of data, shall be as prescribed in the reference table on page A3-31. Each message shall contain all the fields prescribed.

1.4 Composition of the standard types of field

The composition of each standard type of field, expressed as a standardized sequence of elements of data, or in some cases as a simple element, shall be as prescribed in the field tables on pages A3-6 to A3-30.

Note.— Each type of field contains at least one mandatory element and, except in Field Type 9, this is the first or only element in the field. The rules for the inclusion or omission of conditional elements are indicated in the field tables.

1.5 Structuring and punctuation

1.5.1 The beginning of the ATS data shall be indicated on page copy by an open bracket ‘(’, which constitutes the Start-of-ATS-Data Signal. This signal shall be used only as the printed character immediately preceding the message type designator.

Note.— In teletypewriter operation using International Telegraph Alphabet No. 2, the open bracket is transmitted as the Figures Case of Signal No. 11. On some teletypewriter machines, this will print as a symbol other than ‘(’, but this variation will be local and of no consequence. Where higher level codes are employed, the character printing as ‘(’ is used.

1.5.2 The beginning of each field, other than the first, shall be indicated by a single hyphen ‘-’, which constitutes the Start-of-Field Signal. This signal shall be used only as the printed character preceding the first element of ATS data in each field.

Note.— In teletypewriter operation using International Telegraph Alphabet No. 2, the single hyphen is transmitted as the Figures Case of Signal No. 1. On some teletypewriter machines, this will print as a symbol other than ‘-’, but this variation will be local and of no consequence. Where higher level codes are employed, the character printing as ‘-’ is used.

1.5.3 Elements within a field shall be separated by an oblique stroke ‘/’ (see Note 1), or a space (sp.) (see Note 2) only where so prescribed in the field tables on pages A3-6 to A3-30.

Note 1.— In teletypewriter operation using International Telegraph Alphabet No. 2, the oblique stroke is transmitted as the Figures Case of Signal No. 24. On some teletypewriter machines, this will print as a symbol other than ‘/’, but this variation will be local and of no consequence. Where higher level codes are employed, the character printing as ‘/’ is used.

Note 2.— In teletypewriter operation using International Telegraph Alphabet No. 2, the space is transmitted as Signal No. 31. Where higher level codes are employed, the character which causes a space on page copy is to be used.

1.5.4 The end of the ATS data shall be indicated by a close bracket ‘)’, which constitutes the End-of-ATS-Data Signal. This signal shall be used only as the printed character immediately following the last field in the message.

Note.— In teletypewriter operation using International Telegraph Alphabet No. 2, the close bracket is transmitted as Signal No. 12. On some teletypewriter machines, this will print as a symbol other than ‘)’, but this variation will be local and of no consequence. Where higher level codes are employed, the character printing as ‘)’ is to be used.

1.5.5 When the standard ATS messages are prepared in teletypewriter form, an Alignment Function (two Carriage Returns followed by one Line Feed) shall be inserted:

- a) prior to each of the fields so annotated in the reference table on page A3-31;
- b) in Fields Type 5 (Description of emergency), 15 (Route), 18 (Other information), 19 (Supplementary information), 20 (Alerting search and rescue information), 21 (Radio failure information) and 22 (Amendment), whenever it is necessary to begin a new line on page copy (see Note). In such cases, the Alignment Function shall be inserted between two data elements and shall not divide an element.

Note.— Annex 10, Volume II, prescribes that a line of teletypewriter copy shall not contain more than 69 characters.

1.6 Data conventions

1.6.1 Most of the conventions to be used in the expression of ATS data in the messages are prescribed in the field tables on pages A3-6 to A3-30, but the conventions for the expression of level, position and route data are given below to simplify the field tables.

1.6.2 *The expression of level data*

Four alternative conventions are available for the expression of level data:

- a) *“F” followed by 3 decimal numerics*: indicates a flight level number, i.e. Flight Level 330 is expressed as “F330”;
- b) *“S” followed by 4 decimal numerics*: indicates standard metric level in tens of metres, i.e. Standard Metric Level 11 300 metres (Flight Level 370) is expressed as “S1130”;
- c) *“A” followed by 3 decimal numerics*: indicates altitude in hundreds of feet, i.e. an altitude of 4 500 feet is expressed as “A045”;
- d) *“M” followed by 4 decimal numerics*: indicates altitude in tens of metres, i.e. an altitude of 8 400 metres is expressed as “M0840”.

1.6.3 *The expression of position or route*

The following alternative data conventions shall be used for the expression of position or route:

- a) from 2 to 7 characters, being the coded designator assigned to an ATS route to be flown;
- b) from 2 to 5 characters, being the coded designator assigned to an en-route point;
- c) 4 numerics describing latitude in degrees and tens and units of minutes, followed by “N” (meaning “North”) or “S” (South), followed by 5 numerics describing longitude in degrees and tens and units of minutes, followed by “E” (East) or “W” (West). The correct number of numerics is to be made up, where necessary, by the insertion of zeros, e.g. “4620N07805W”;
- d) 2 numerics describing latitude in degrees, followed by “N” (North) or “S” (South), followed by 3 numerics describing longitude in degrees, followed by “E” (East) or “W” (West). Again, the correct number of numerics is to be made up, where necessary, by the insertion of zeros, e.g. “46N078W”;

e) 2 or 3 characters being the coded identification of a navigation aid (normally a VOR), followed by 3 decimal numerics giving the bearing from the point in degrees magnetic followed by 3 decimal numerics giving the distance from the point in nautical miles. The correct number of numerics is to be made up, where necessary, by the insertion of zeros, e.g. a point at 180° magnetic at a distance of 40 nautical miles from VOR “FOJ” would be expressed as “FOJ180040”.

1.7 The detail of the fields

1.7.1 The elements of data prescribed or permitted to be included in each type of field, together with a prescription of the conditions or options permitted, are shown on pages A3-6 to A3-30.

1.7.2 A key appears at the right-hand side of each of the field pages; this key permits the sequence of fields in each type of message to be followed.

1.7.3 The first field in each message type is Field Type 3; on the page describing Field Type 3 a key indicates the field type number of the next field for each message. On subsequent field pages, the field type number of the previous field is shown to permit back reference also. The Start-of-ATS-Data Signal ‘(’ is used in the key to indicate that there is no previous type of field; the End-of-ATS-Data Signal ‘)’ is used to indicate that there is no next type of field.

1.7.4 On the field pages, elements with a fixed number of characters are shown

diagrammatically as (three characters in this example)

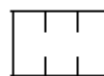

elements of variable length are shown as



1.8 Accuracy in the preparation of ATS messages

Where the standard ATS messages are transmitted by teletypewriter channels in areas where ATC computers are known to be in use, the formats and data conventions prescribed in the field tables on pages A3-6 to A3-30 shall be adhered to rigorously.

Field Type 3 — Message type, number and reference data

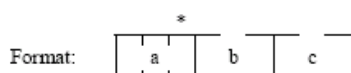

OPEN BRACKET

(a) *Message type designator*

3 LETTERS as follows:

ALR	Alerting
RCF	Radiocommunication failure
FPL	Filed flight plan
CHG	Modification
CNL	Cancellation
DLA	Delay
DEP	Departure
ARR	Arrival
CPL	Current flight plan
EST	Estimate
CDN	Coordination
ACP	Acceptance
LAM	Logical acknowledgement
RQP	Request flight plan
RQS	Request supplementary flight plan
SPL	Supplementary flight plan

* Unless instructed otherwise, this field shall contain only the single element (a). Elements (b) or (b) and (c) are for use when messages are generated by, and/or exchanged between, the computer systems of ATS units.

(b) *Message number*

1 to 4 LETTER(S)	identifying the sending ATS unit, followed by
OBLIQUE STROKE (/)	followed by
1 to 4 LETTER(S)	identifying the receiving ATS unit, followed by
3 DECIMAL NUMERICS	giving the serial number of this message in the sequence of messages transmitted by this unit to the indicated receiving ATS unit.

(c) *Reference data*

1 to 4 LETTER(S) followed by OBLIQUE STROKE (/) followed by 1 to 4 LETTER(S) followed by 3 DECIMAL NUMERICS, giving the “message number” contained in element (b) of the operational message which began the sequence of messages of which this message is a part.

Examples: (FPL
(CNL
(CHGA/B234A/B231
(CPLA/B002

FIELD TYPE 3

Previous type of field or symbol	This type of field is used in	Next type of field or symbol
(ALR	5
(RCF	7
(FPL	7
(CHG	7
(CNL	7
(DLA	7
(DEP	7
(ARR	7
(CPL	7
(EST	7
(CDN	7
(ACP	7
(LAM)
(RQP	7
(RQS	7
(SPL	7

Field Type 5 — Description of emergency

Format: – [a] / [b] / [c]

SINGLE HYPHEN

(a) *Phase of emergency*
 or INCERFA if an uncertainty phase,
 or ALERFA if an alert phase,
 DETRESFA if a distress phase
 has been declared in respect of the aircraft concerned.

OBLIQUE STROKE

(b) *Originator of message*
 8 LETTERS, being the 4-letter ICAO location indicator plus the 3-letter designator of the ATS unit originating the message followed by the letter X or, if applicable, the one-letter designator identifying the division of the ATS unit originating the message.

OBLIQUE STROKE

(c) *Nature of emergency*
 SHORT PLAIN-LANGUAGE TEXT, as necessary to explain the nature of the emergency, with natural spaces between the words.

Example: –ALERFA/EINNZQZX/REPORT OVERDUE

FIELD TYPE 5

<i>Previous type of field or symbol</i>	<i>This type of field is used in</i>	<i>Next type of field or symbol</i>
3	ALR	7

Field Type 7 – Aircraft identification and SSR mode and code

Format: –

(a) Max. 7 characters

 /

b	c
---	---

*

SINGLE HYPHEN

(a) *Aircraft identification*

NOT MORE THAN 7 CHARACTERS, being the aircraft identification shown in the filed flight plan and composed as specified in Appendix 2, Section 2.

* This field may be terminated here in messages relating to flights operating within areas where SSR is not used, or when the SSR code information is not known or would not be meaningful to the accepting unit.

OBLIQUE STROKE

(b) *SSR mode*

LETTER A giving the SSR mode related to (c).

(c) *SSR code*

4 NUMERICS giving the SSR code assigned to the aircraft by ATS and transmitted in the mode given in (b).

Examples: –BAW902
–SAS912/A5100

FIELD TYPE 7

Previous type of field or symbol	This type of field is used in	Next type of field or symbol
5 3	ALR RCF	8 21
3 3 3 3 3 3	FPL CHG CNL DLA DEP ARR	8 13 13 13 13 13
3 3 3 3	CPL EST CDN ACP	8 13 13 13
3 3 3	RQP RQS SPL	13 13 13

Field Type 8 – Flight rules and type of flight

Format: –

*
a b

SINGLE HYPHEN

<p>(a) <i>Flight rules</i></p> <p>1 LETTER as follows:</p> <p>I if IFR V if VFR Y if IFR first Z if VFR first</p> <p style="text-align: center;"><i>Note.— If the letter Y or Z is used, the point or points at which a change of flight rules is planned is to be shown as indicated in Field Type 15.</i></p>

* This field shall be terminated here unless indication of the type of flight is required by the appropriate ATS authority.

<p>(b) <i>Type of flight</i></p> <p>1 LETTER as follows:</p> <p>S if scheduled air transport N if non-scheduled air transport G if general aviation M if military X other flights</p>

Examples: –V
 –IS

FIELD TYPE 8

Previous type of field or symbol	This type of field is used in	Next type of field or symbol
7	ALR	9
7	FPL	9
7	CPL	9

Field Type 9 — Number and type of aircraft and wake turbulence category

Format: -

a	b
---	---

 /

c

SINGLE HYPHEN

(a) *Number of aircraft (if more than one)*

Note.— This element is included only in the case of formation flights.

1 OR 2 NUMERICS giving the number of aircraft in the flight.

(b) *Type of aircraft*

2 to 4 CHARACTERS, being the appropriate designator chosen from ICAO Doc 8643, *Aircraft Type Designators*, or

ZZZZ if no designator has been assigned or if there is more than one type of aircraft in the flight.

Note.— If the letters ZZZZ are used, the type(s) of aircraft is (are) to be shown in the Other Information Field (see Field Type 18).

OBLIQUE STROKE

(c) *Wake turbulence category*

1 LETTER to indicate maximum certificated take-off mass of the aircraft:

H — Heavy
M — Medium
L — Light

Examples: -DC3/M
 -B707/M
 -2FK27/M
 -ZZZZ/L
 -3ZZZZ/L
 -B747/H

FIELD TYPE 9

Previous type of field or symbol	This type of field is used in	Next type of field or symbol
8	ALR	10
8	FPL	10
8	CPL	10

Field Type 10—Equipment

Format: – a / b

SINGLE HYPHEN

(a) *Radiocommunication, navigation and approach aid equipment*

1 LETTER as follows:

N no COM/NAV/approach aid equipment for the route to be flown is carried, or the equipment is unserviceable

OR S Standard COM/NAV/approach aid equipment for the route to be flown is carried and serviceable (*see Note 1*)

AND/OR ONE OR MORE OF THE FOLLOWING LETTERS to indicate the COM/NAV/approach aid equipment serviceable

A (Not allocated)	M Omega
B (Not allocated)	O VOR
C LORAN C	P (Not allocated)
D DME	Q (Not allocated)
E (Not allocated)	R RNP type certification (<i>see Note 5</i>)
F ADF	T TACAN
G (GNSS)	U UHF RTF
H HF RTF	V VHF RTF
I Inertial navigation	W } When
J (Data link) (<i>see Note 3</i>)	X } prescribed
K (MLS)	Y } by ATS
L ILS	Z Other equipment carried (<i>see Note 2</i>)

Note 1.— Standard equipment is considered to be VHF RTF, ADF, VOR and ILS, unless another combination is prescribed by the appropriate ATS authority.

Note 2.— If the letter Z is used, the equipment carried is to be specified in Item 18, preceded by COM/ and/or NAV/ , as appropriate.

Note 3.— If the letter J is used, specify in Item 18 the equipment carried, preceded by DAT/ followed by one or more letters as appropriate.

Note 4.— Information on navigation capability is provided to ATC for clearance and routing purposes.

Note 5.— Inclusion of letter R indicates that an aircraft meets the RNP type prescribed for the route segment(s), route(s) and/or area concerned.

FIELD TYPE 10

Previous type of field or symbol	This type of field is used in	Next type of field or symbol
9	ALR	13
9	FPL	13
9	CPL	13

OBLIQUE STROKE

(b) *Surveillance equipment*

ONE OR TWO LETTERS to describe the serviceable surveillance equipment carried:

SSR equipment

- N Nil
- A Transponder — Mode A (4 digits — 4 096 codes)
- C Transponder — Mode A (4 digits — 4 096 codes) and Mode C
- X Transponder — Mode S without both aircraft identification and pressure-altitude transmission
- P Transponder — Mode S, including pressure-altitude transmission, but no aircraft identification transmission
- I Transponder — Mode S, including aircraft identification transmission, but no pressure-altitude transmission
- S Transponder — Mode S, including both pressure-altitude and aircraft identification transmission

ADS equipment

- D ADS capability

Examples: -S/A
-SCHJ/CD
-SAFJ/SD

Field Type 13 — Departure aerodrome and time

Format: —

*
a
b

SINGLE HYPHEN

(a) *Departure aerodrome*

4 LETTERS, being

the ICAO four-letter location indicator allocated to the departure aerodrome, or

ZZZZ if no ICAO location indicator has been allocated (*see Note 1*) or if the departure aerodrome is not known, or

AFIL if the flight plan has been filed in the air (*see Note 2*).

Note 1.— If ZZZZ is used, the name of the departure aerodrome is to be shown in the Other Information Field (see Field Type 18) if this Field Type is contained in the message.

Note 2.— If AFIL is used, the ATS unit from which supplementary flight data can be obtained is to be shown in the Other Information Field (Field Type 18).

* This field shall be terminated here in message types CHG, CNL, ARR, CPL, EST, CDN, ACP and RQS. It shall be terminated here in message type RQP if the estimated off-block time is not known.

(b) *Time*

4 NUMERICS giving

the estimated off-block time at the aerodrome in (a) in FPL and DLA messages transmitted before departure and in RQP message, if known, or

the actual time of departure from the aerodrome in (a) in ALR, DEP and SPL messages, or

the actual or estimated time of departure from the first point shown in the Route Field (see Field Type 15) in FPL messages derived from flight plans filed in the air, as shown by the letters AFIL in (a).

Examples: —EHAM0730
 —AFIL1625

FIELD TYPE 13

Previous type of field or symbol	This type of field is used in	Next type of field or symbol
10	ALR	15
10	FPL	15
7	CHG	16
7	CNL	16
7	DLA	16
7	DEP	16
7	ARR	(16)** 17
10	CPL	14
7	EST	14
7	CDN	16
7	ACP	16
7	RQP	16
7	RQS	16
7	SPL	16

** Only in case of a diversionary landing

Field Type 14 – Estimate data

Format: – [a] / [b] [c] [d] [e]

SINGLE HYPHEN

(a) *Boundary point (see Note 1)*

The BOUNDARY POINT expressed either by a designator consisting of 2 to 5 characters, in geographical coordinates, in abbreviated geographical coordinates, or by bearing and distance from a designated point (e.g. a VOR).

Note 1.— This point may be an agreed point located close to, rather than on, the FIR boundary.

Note 2.— See 1.6 for data conventions.

OBLIQUE STROKE

(b) *Time at boundary point*

4 NUMERICS giving the estimated time at the boundary point.

(c) *Cleared level*

F followed by 3 NUMERICS, or
 S followed by 4 NUMERICS, or
 A followed by 3 NUMERICS, or
 M followed by 4 NUMERICS

} See data conventions in 1.6 of this Appendix.

giving the cleared level at which the aircraft will cross the boundary point, if in level cruising flight, or the cleared level to which it is proceeding, if climbing or descending at the boundary point.

* This field will be terminated here if the aircraft will cross the boundary point in level cruising flight.

FIELD TYPE 14

Previous type of field or symbol	This type of field is used in	Next type of field or symbol
13	CPL	15
13	EST	16

(d) *Supplementary crossing data*

A LEVEL, expressed as in (c), at or above which or at or below which (see (e)) the aircraft will cross the boundary point.

(e) *Crossing condition*

1 LETTER as follows:

A if the aircraft will cross the boundary point at or above the level in (d),
or

B if the aircraft will cross the boundary point at or below the level in (d).

Examples: -LN/1746F160
-CLN/1831F240F180A
-5420N05000W/0417F290
-LNX/1205F160F200B
-ZD126028/0653F130

Field Type 15 — Route

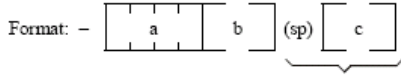

See Note in margin.

SINGLE HYPHEN

(a) *Cruising speed or Mach number*

The true airspeed for the first or the whole cruising portion of the flight, in terms of:

K followed by 4 NUMERICS giving the true airspeed in kilometres per hour, or

N followed by 4 NUMERICS giving the true airspeed in knots, or

when so prescribed by the appropriate ATS authority, M followed by 3 NUMERICS giving the true Mach number to the nearest hundredth of unit Mach.

(b) *Requested cruising level*

F followed by 3 NUMERICS, or

S followed by 4 NUMERICS, or

A followed by 3 NUMERICS, or

M followed by 4 NUMERICS, or

VFR.

} See data conventions in 1.6 of this Appendix.

SPACE

followed by a string of elements/groups of elements of the following seven types separated by SPACES, in whatever sequence is necessary to describe the route in an unambiguous manner (see Appendix 2, Section 2).

Note.— Further element groups of elements (c) should be added, as necessary, each to be preceded by a space.

FIELD TYPE 15		
---------------	--	--

Previous type of field or symbol	This type of field is used in	Next type of field or symbol
13	ALR	16
13	FPL	16
14	CPL	16

(c1) *Standard departure route*

The designator for the standard departure route from the aerodrome of departure to the first significant point on the defined route to be flown.

Note 1.— See data convention in 1.6.3 a) of this Appendix.

Note 2.— Element (c1) may be followed by (c3) or (c4).

Note 3.— Standard departure route need be included only where appropriate.

(c2) *ATS route designator*

Note 1.— See data convention in 1.6.3 a) of this Appendix.

Note 2.— Element (c2) may be followed by (c3) or (c4) only.

(c3) *Significant point*

Note.— See alternative data conventions in 1.6.3 b), c), d) and e) of this Appendix.

(c4) *Significant point/cruising speed and cruising level*

SIGNIFICANT POINT (as in element (c3))

OBLIQUE STROKE

CRUISING SPEED OR MACH NUMBER (as in element (a))

REQUESTED CRUISING LEVEL (as in element (b)).

(c5) <i>Indicator</i>	
VFR	if a change to VFR is to be made at the preceding point, or
IFR	if a change to IFR is to be made at the preceding point, or
DCT	if the flight to the next point will be outside a designated route, unless both points are defined by geographical coordinates or by bearing and distance.
T	if the route description is truncated at the preceding point and the remainder is to be sought in a previously transmitted FPL or other data.
<i>Note 1.— Element (c5) may follow (c3) or (c4) and (c6) only.</i>	
<i>Note 2.— When used, T must conclude the Route Field.</i>	

(c6) <i>Cruise climb</i>	
The letter C followed by an oblique stroke; then the point at which cruise climb is planned to start, expressed exactly as in (c3) above, followed by an oblique stroke; then the speed to be maintained during cruise climb expressed exactly as in (a) above followed by <i>the two levels</i> defining the layer to be occupied during cruise climb; each level expressed as in (b) above, or the level above which cruise climb is planned, followed by the letters PLUS, without a space between them.	

(c7) <i>Standard arrival route</i>	
The designator for the standard arrival route from the point of leaving the defined route to the point at which the approach procedure is initiated.	
<i>Note.— Standard arrival route need only be included where appropriate.</i>	

Examples: -K0410S1500 A4 CCV R11
 -K0290A120 BR 614
 -N0460F290 LEK2B LEK UA6 FNE UA6 XMM/M078F330 UA6N PON UR10N
 CHW UA5 NTS DCT 4611N00412W DCT STG UA5 FTM FATIM1A
 -M082F310 BCN1G BCN UG1 52N015W 52N020W 52N030W 50N040W
 49N050W DCT YQX
 -N0420F310 R10 UB19 CGC UA25 DIN/N0420F330 UR14 IBY UR1 MID

Field Type 16 — Destination aerodrome and total estimated elapsed time, alternate aerodrome(s)

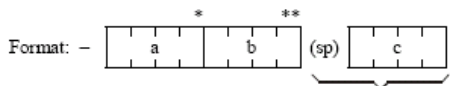

See Note in margin on page A3-21.

SINGLE HYPHEN

(a) *Destination aerodrome*

4 LETTERS, being

the ICAO four-letter location indicator allocated to the destination aerodrome, or

ZZZZ if no ICAO location indicator has been allocated.

Note.— If ZZZZ is used, the name of the destination aerodrome is to be shown in the Other Information Field (see Field Type 18).

* This field is to be terminated here in all message types other than ALR, FPL and SPL.

(b) *Total estimated elapsed time*

4 NUMERICS, giving

the total estimated elapsed time.

** This field may be terminated here in FPL messages when so agreed between the ATS units concerned or prescribed on the basis of regional air navigation agreements.

FIELD TYPE 16

<i>Previous type of field or symbol</i>	<i>This type of field is used in</i>	<i>Next type of field or symbol</i>
15	ALR	18
15 13 13 13 13 13	FPL CHG CNL DLA DEP ARR***	18 22)))) 17
15 14 13 13	CPL EST CDN ACP	18) 22)
13 13	RQS SPL) 18

*** Only in case of a diversionary landing

SPACE

(c) *Alternate aerodrome(s)*
4 LETTERS, being
the ICAO four-letter location indicator allocated to an alternate aerodrome,
or
ZZZZ if no ICAO location indicator has been allocated.

*Note.— If ZZZZ is used, the name of the alternate aerodrome is to be shown
in the Other Information Field (see Field Type 18).*

*Note.— One further element of
(c) should be added, as necessary,
preceded by a space.*

Examples: -EINN0630
-EHAM0645 EBBR
-EHAM0645 EBBR EDDL

Field Type 17 – Arrival aerodrome and time

Format: –

a	b
---	---

 * (sp)

c

SINGLE HYPHEN

(a) *Arrival aerodrome*
4 LETTERS, being
the ICAO four-letter location indicator allocated to the arrival aerodrome, or
ZZZZ if no ICAO location indicator has been allocated.

(b) *Time of arrival*
4 NUMERICS, giving
the actual time of arrival.

* This field is to be terminated here if an ICAO location indicator has been allocated to the arrival aerodrome.

SPACE

(c) *Arrival aerodrome*
Name of arrival aerodrome, if ZZZZ is inserted in (a).

Examples: –EHAM1433
–ZZZZ1620 DEN HELDER

FIELD TYPE 17

<i>Previous type of field or symbol</i>	<i>This type of field is used in</i>	<i>Next type of field or symbol</i>
13 (16)**	ARR)

** Only in case of a diversionary landing

Field Type 18 — Other information

Format: – [A]

– []^{or} [] (sp) [] [] (sp) * (sp) [] []
(* additional elements as necessary)

SINGLE HYPHEN

(a) 0 (zero) if no other information

OR

Any other necessary information in the preferred sequence shown hereunder, in the form of the appropriate abbreviation followed by an oblique stroke and the information to be recorded:

EET/ Significant points or FIR boundary designators and accumulated estimated elapsed times to such points or FIR boundaries, when so prescribed on the basis of regional air navigation agreements, or by the appropriate ATS authority.

Examples: EET/CAP0745 XYZ0830
EET/EINN0204

RIF/ The route details to the revised destination aerodrome, followed by the ICAO four-letter location indicator of the aerodrome. The revised route is subject to re-clearance in flight.

Examples: RIF/DTA HEC KLAX
RIF/ESP G94 CLA YPPH
RIF/LEMD

REG/ The registration markings of the aircraft, only if necessary and if different from the aircraft identification in Item 7.

SEL/ SELCAL code, if so prescribed by the appropriate ATS authority.

OPR/ Name of the operator, if not obvious from the aircraft identification in Item 7.

FIELD TYPE 18

Previous type of field or symbol	This type of field is used in	Next type of field or symbol
16	ALR	19
16	FPL)
16	CPL)
16	SPL	19

Field Type 18 (cont.)

STS/	Reason for special handling by ATS, e.g. hospital aircraft, one engine inoperative, e.g. STS/HOSP, STS/ONE ENG INOP.
TYP/	Type(s) of aircraft, preceded if necessary by number(s) of aircraft, if ZZZZ is inserted in Item 9.
PER/	Aircraft performance data, if so prescribed by the appropriate ATS authority.
COM/	Significant data related to communication equipment as required by the appropriate ATS authority, e.g. COM/UHF only.
DAT/	Significant data related to data link capability, using one or more of the letters S, H, V and M, e.g. DAT/S for satellite data link, DAT/H for HF data link, DAT/V for VHF data link, DAT/M for SSR Mode S data link.
NAV/	Significant data related to navigation equipment as required by the appropriate ATS authority.
DEP/	Name of departure aerodrome, if ZZZZ is inserted in Item 13, or the ICAO four-letter location indicator of the location of the ATS unit from which supplementary flight plan data can be obtained, if AFIL is inserted in Item 13.
DEST/	Name of destination aerodrome, if ZZZZ is inserted in Item 16.
ALTN/	Name of destination alternate aerodrome(s), if ZZZZ is inserted in Item 16.
RALT/	Name of en-route alternate aerodrome(s).
CODE/	Aircraft address (expressed in the form of an alphanumerical code of six hexadecimal characters) when required by the appropriate ATS authority. Example: "F00001" is the lowest aircraft address contained in the specific block administered by ICAO.
RMK/	Any other plain-language remarks when required by the appropriate ATS authority or deemed necessary by the pilot-in-command for the provision of air traffic services.

Examples: -0
 -EET/15W0315 20W0337 30W0420 40W0502
 -STS/ONE ENG INOP
 -DAT/S

Field Type 19 – Supplementary information

Format: – [] [] (sp) [] [] (sp) * (sp) [] []
(* additional elements as necessary)

This field consists of such supplementary information as is available, organized into a string of elements separated by spaces.

The permissible elements in their proper sequence are:

SINGLE HYPHEN

- (a) E/ followed by 4 NUMERICS giving the fuel endurance in hours and minutes.
- (b) P/ followed by 1, 2 or 3 NUMERICS giving the total number of persons on board, when so prescribed by the appropriate ATS authority.
- (c) R/ followed by one or more of the following, without spaces:
 - U if frequency 243.0 MHz (UHF) is available,
 - V if frequency 121.5 MHz (VHF) is available,
 - E if emergency locator transmitter (ELT) is available.
- (d) S/ followed by one or more of the following, without spaces:
 - P if polar survival equipment is carried,
 - D if desert survival equipment is carried,
 - M if maritime survival equipment is carried,
 - J if jungle survival equipment is carried.
- (e) J/ followed by one or more of the following, without spaces:
 - L if the life jackets are equipped with lights,
 - F if they are equipped with fluorescein, followed by space followed by
 - U if any life jacket radio is equipped with UHF on frequency 243.0 MHz,
 - V if any life jacket radio is equipped with VHF on frequency 121.5 MHz.

FIELD TYPE 19

<i>Previous type of field or symbol</i>	<i>This type of field is used in</i>	<i>Next type of field or symbol</i>
18	ALR	20
18	SPL)

Field Type 19 (cont.)

(f) D/ followed by one or more of the following, separated by spaces:
2 NUMERICS giving the number of dinghies carried,
3 NUMERICS giving the total capacity, in persons carried, of all dinghies.
C if dinghies are covered.
The colour of the dinghies (e.g. RED).

(g) A/ followed by one or more of the following, separated by spaces:
The colour of the aircraft.
Significant markings (this may include the aircraft registration).

(h) N/ followed by plain language indicating any other survival equipment carried and any other useful remarks.

(i) C/ followed by the name of the pilot-in-command.

Example: -E/0745 P/6 R/VE S/M J/L D/2 8 C YELLOW
A/YELLOW RED TAIL N145E C/SMITH

Field Type 20 — Alerting search and rescue information

Format: – [] [] (sp) [] [] (sp) * (sp) [] []
(*EIGHT elements in all)

This field consists of the following specified sequence of elements separated by spaces. Any information not available should be shown as “NIL” or “NOT KNOWN” and not simply omitted.

SINGLE HYPHEN

(a) *Identity of operator*
The ICAO two-letter designator of the aircraft operating agency or, if this has not been assigned, the name of the operator.

(b) *Unit which made last contact*
6 LETTERS consisting of the 4-letter ICAO location indicator followed by the 2-letter designator which together identify the ATS unit which made the last two-way contact or, if these are not available, some other description of the unit.

(c) *Time of last two-way contact*
4 NUMERICS giving the time of the last two-way contact.

(d) *Frequency of last contact*
NUMERICS as necessary giving the transmitting/receiving frequency of the last contact.

(e) *Last reported position*
The last reported position expressed in one of the data conventions of 1.6 of this Appendix followed by the time over that position.

Field Type 20 (cont.)

(f) *Method of determining last known position*
Plain-language text as necessary.

(g) *Action taken by reporting unit*
Plain-language text as necessary.

(h) *Other pertinent information*
Plain-language text as necessary.

Example: –USAF LGGGZAZX 1022 126.7 GN 1022
PILOT REPORT OVER NDB ATS UNITS
ATHENS FIR ALERTED NIL

FIELD TYPE 20

<i>Previous type of field or symbol</i>	<i>This type of field is used in</i>	<i>Next type of field or symbol</i>
19	ALR)

Field Type 21 – Radio failure information

Format: – [] [] (sp) [] [] (sp) * (sp) [] []
(*SIX elements in all)

This field consists of the following specified sequence of elements preceded by a single hyphen and separated by spaces. Any information not available is to be shown as “NIL” or “NOT KNOWN” and not simply omitted.

SINGLE HYPHEN

- (a) *Time of last two-way contact*
4 NUMERICS giving the time of the last two-way contact with the aircraft.
- (b) *Frequency of last contact*
NUMERICS as necessary giving the transmitting/receiving frequency of the last two-way contact with the aircraft.
- (c) *Last reported position*
The last reported position expressed in one of the data conventions of 1.6 of this Appendix.
- (d) *Time at last reported position*
4 NUMERICS giving the time at the last reported position.
- (e) *Remaining COM capability*
LETTERS as necessary identifying the remaining COM capability of the aircraft, if known, using the convention of Field Type 10, or in plain language.
- (f) *Any necessary remarks*
Plain-language text as necessary.

Example: –1232 121.3 CLA 1229 TRANSMITTING ONLY 126.7
LAST POSITION CONFIRMED BY RADAR

FIELD TYPE 21

<i>Previous type of field or symbol</i>	<i>This type of field is used in</i>	<i>Next type of field or symbol</i>
7	RCF)

Field Type 22 – Amendment

Format: – [] a [] / [] b []

SINGLE HYPHEN

(a) *Field indicator*
ONE OR TWO NUMERIC'S giving the type number of the field to be amended.

OBLIQUE STROKE

(b) *Amended data*
The complete and amended data of the field indicated in (a), constructed as specified for that field.

FIELD TYPE 22

<i>Previous type of field or symbol</i>	<i>This type of field is used in</i>	<i>Next type of field or symbol</i>
16	CHG	*22 or)
16	CDN	*22 or)

* Indicates that further fields of this type may be added

Example of amendment of Field Type 8 (Flight rules and type of flight) to IN:

–8/IN

Example of amendment of Field Type 14 (Estimate data):

–14/ENO/0145F290A090A

Example of amendment of Fields Type 8 (Flight rules and type of flight) and 14 (Estimate data):

–8/I-14/ENO/0148F290A110A

RULES FOR THE COMPOSITION OF ATS MESSAGES
(See Sections 1.3 to 1.8 of this Appendix)

STANDARD ATS MESSAGES AND THEIR COMPOSITION

DESIGNATOR	MESSAGE TYPE	MESSAGE FIELDS																						FIELD TYPE NUMBERS
		Not message text	Message text	Message text number and reference	Not message text	Message text	Message text number and reference	Not message text	Message text	Message text number and reference	Not message text	Message text	Message text number and reference	Not message text	Message text	Message text number and reference	Not message text	Message text	Message text number and reference	Not message text	Message text	Message text number and reference		
Alerting	ALR		3		5		7	8	9	10		13		15	16	18	19	20					Emergency messages	
Radiocommunication failure	RCF		3				7														21		Emergency messages	
Filed flight plan	FPL		3				7	8	9	10		13		15	16	18	19						Field flight plan messages and associated update messages	
Delay	DLA		3				7					13		15	16								Field flight plan messages and associated update messages	
Modification	CHG		3				7					13		15	16								Field flight plan messages and associated update messages	
Flight plan cancellation	CNL		3				7					13		15	16								Field flight plan messages and associated update messages	
Departure	DEP		3				7					13		15	16								Field flight plan messages and associated update messages	
Arrival	ARR		3				7					13		15	16	17							Field flight plan messages and associated update messages	
Current flight plan	CPL		3				7	8	9	10		13	14	15	16								Field flight plan messages and associated update messages	
Estimate	EST		3				7					13	14	15	16								Field flight plan messages and associated update messages	
Coordination	CMN		3				7					13		15	16								Coordination messages	
Acceptance	ACP		3				7					13		15	16								Coordination messages	
Logical acknowledgment message	LAM		3																				Coordination messages	
Request flight plan	RQP		3				7					13		15	16								Supplementary messages	
Request supplementary flight plan	RQS		3				7					13		15	16								Supplementary messages	
Supplementary flight plan	SPL		3				7					13		15	16	18	19						Supplementary messages	

◻ This field begins a new line when the message is printed in page teleprinter form. ◻ This field is repeated as necessary.

Composition of the standard types of message

The composition of each standard type of message, expressed as a standardized sequence of fields of data, shall be as prescribed in the reference table on this page. Each message shall contain all the fields prescribed.

Composition of the standard types of field

The composition of each standard type of field, expressed as a standardized sequence of elements of data, or in some cases as a simple element, shall be as prescribed in the field tables on pages A3-4 to A3-30.

Note— Each type of field contains at least one mandatory element, and, except in Field Type 9, this is the first or only element in the field. The rules for the inclusion or omission of optional elements are indicated in the field tables.

Stacking and punctuation

The beginning of the ATS data shall be indicated on page copy by an open bracket '(', which constitutes the Start-of-ATS-Data Signal. This signal shall be used only as the period character immediately preceding the message type designator.

Note— In teleprinter operation using International Telegraph Alphabet No. 2, the open bracket is transmitted as the Figure Case of Signal No. 11. On some teleprinter machines, this will print as a symbol other than '(', but this variation will be local and of no consequence. Where higher level codes are employed, the character printing as ')' is used.

The beginning of each field, other than the first, shall be indicated by a single hyphen '-', which constitutes the Start-of-Field Signal. This signal shall be used only as the period character preceding the first element of ATS data in each field.

Note— In teleprinter operation using International Telegraph Alphabet No. 2, the single hyphen is transmitted as the Figure Case of Signal No. 7. On some teleprinter machines, this will print as a symbol other than '-', but this variation will be local and of no consequence. Where higher level codes are employed, the character printing as '-' is used.

Elements within a field shall be separated by an oblique stroke '/' (see Note 1), or a space (sp.) (see Note 2) only where so prescribed in the field tables on pages A3-4 to A3-30.

Note 1— In teleprinter operation using International Telegraph Alphabet No. 2, the oblique stroke is transmitted as the Figure Case of Signal No. 24. On some teleprinter machines, this will print as a symbol other than '/', but this variation will be local and of no consequence. Where higher level codes are employed, the character printing as '/' is used.

Note 2— In teleprinter operation using International Telegraph Alphabet No. 2, the space is transmitted as Signal No. 31. Where higher level codes are employed, the character which causes a space on page copy is to be used.

The end of the ATS data shall be indicated by a close bracket ')', which constitutes the End-of-ATS-Data Signal. This signal shall be used only as the period character immediately following the last field in the message.

Note— In teleprinter operation using International Telegraph Alphabet No. 2, the close bracket is transmitted as Signal No. 12. On some teleprinter machines, this will print as a symbol other than ')', but this variation will be local and of no consequence. Where higher level codes are employed, the character printing as ')' is to be used.

When the standard ATS messages are prepared in teleprinter form, an Alignment Function (no Carriage Returns followed by one Line Feed) shall be marked.

- (a) prior to each of the fields so annotated in the reference table on this page;
- (b) in Field Type 5 (Description of emergency), 15 (Route), 18 (Other information), 19 (Supplementary information), 20 (Alerting search and rescue information), 21 (Radio failure information) and 22 (Acknowledgment), whenever it is necessary to begin a new line on page copy (see Note 1). In such cases, the Alignment Function shall be inserted between two data elements and shall not divide an element.

Note— Annex 10, Volume II, prescribes that a line of teleprinter copy shall not contain more than 60 characters.

Data conventions

Most of the conventions to be used in the expression of ATS data in the messages are prescribed in the field tables on pages A3-4 to A3-30, but the conventions for the expression of level, position and route data are given below.

The expression of level data

Four alternative conventions are available for the expression of level data:

- (a) "F" followed by 3 decimal numerals: indicates a flight level number, i.e. Flight Level 340 is expressed as "F340";
- (b) "S" followed by 4 decimal numerals: indicates standard metric level in tens of metres, i.e. Standard Metric Level 11 500 m (Flight Level 370) is expressed as "S1150";
- (c) "A" followed by 2 decimal numerals: indicates altitude in hundreds of feet, i.e. an altitude of 4 500 feet is expressed as "A45";
- (d) "M" followed by 4 decimal numerals: indicates altitude in tens of metres, i.e. an altitude of 6 400 metres is expressed as "M640".

The expression of position or route

The following alternative data conventions shall be used for the expression of position or route:

- (a) from 2 to 7 characters, being the coded designator assigned to an ATS route to be flown;

- (b) from 2 to 5 characters, being the coded designator assigned to an en-route point;

- (c) 4 numerals describing latitude in degrees and tens and units of minutes, followed by "N" (northing "North") or "S" (southing), followed by 5 numerals describing longitude in degrees and tens and units of minutes, followed by "E" (east) or "W" (west). The correct number of numerals is to be made up, where necessary, by the insertion of zeros, e.g. "4823N0155W";

- (d) 2 numerals describing latitude in degrees, followed by "N" (North) or "S" (South), followed by 3 numerals describing longitude in degrees, followed by "E" (East) or "W" (West). Again, the correct number of numerals is to be made up, where necessary, by the insertion of zeros, e.g. "48N015W";

- (e) 2 or 3 characters being the coded identification of a navigation aid (normally a VOR), followed by 3 decimal numerals giving the bearing from the point in degrees magnetic followed by 3 decimal numerals giving the distance from the point in nautical miles. The correct number of numerals is to be made up, where necessary, by the insertion of zeros, e.g. a point at 180° magnetic at a distance of 40 nautical miles from VOR "FOJ" would be expressed as "FOJ180340".



The detail of the data

The elements of data prescribed or permitted to be included in each type of field, together with a prescription of the conditions or options permitted, are shown on pages A3-4 to A3-30.

A key appears at the right-hand side of each of the field pages; this key permits the sequence of fields in each type of message to be followed.

The first field in each message type is Field Type 3, on the page describing Field Type 3 a key indicates the field type number of the next field for each message. On subsequent field pages, the field type number of the previous field is shown in parent field reference also. The Start-of-ATS-Data Signal '(' is used in the key to indicate that there is no previous type of field; the End-of-ATS-Data Signal ')' is used to indicate that there is no next type of field.

On the field pages,

- elements with a fixed number of characters are shown diagrammatically as three characters in this example: 
- elements of variable length are shown as: 

Accuracy in the preparation of ATS messages

Where the standard ATS messages are transmitted by teleprinter channels in areas where ATC computers are known to be in use, the format and data conventions prescribed in the field tables on pages A3-4 to A3-30 shall be adhered to rigorously.

2 Examples of ATS messages

2.1 Table of contents

<i>Message category</i>	<i>Message type</i>	<i>Message type designator</i>	<i>Paragraph</i>
Emergency	Alerting Radiocommunication failure	ALR RCF	2.2.1 2.2.2
Filed flight plan and associated update	Filed flight plan Modification Cancellation Delay Departure Arrival	FPL CHG CNL DLA DEP ARR	2.3.1 2.3.2 2.3.3 2.3.4 2.3.5 2.3.6
Coordination	Current flight plan Estimate Coordination Acceptance Logical acknowledgement	CPL EST CDN ACP LAM	2.4.1 2.4.2 2.4.3 2.4.4 2.4.5
Supplementary	Request flight plan Request supplementary flight plan Supplementary flight plan	RQP RQS SPL	2.5.1 2.5.2 2.5.3

Note 1.— Only the ATS information, i.e. in AFTN messages only the AFTN text, is shown.

Note 2.— The numbers in the composition diagrams correspond to the field type numbers used in Section 1 of this Appendix.

2.2 Emergency messages

2.2.1 Alerting (ALR) message

2.2.1.1 Composition

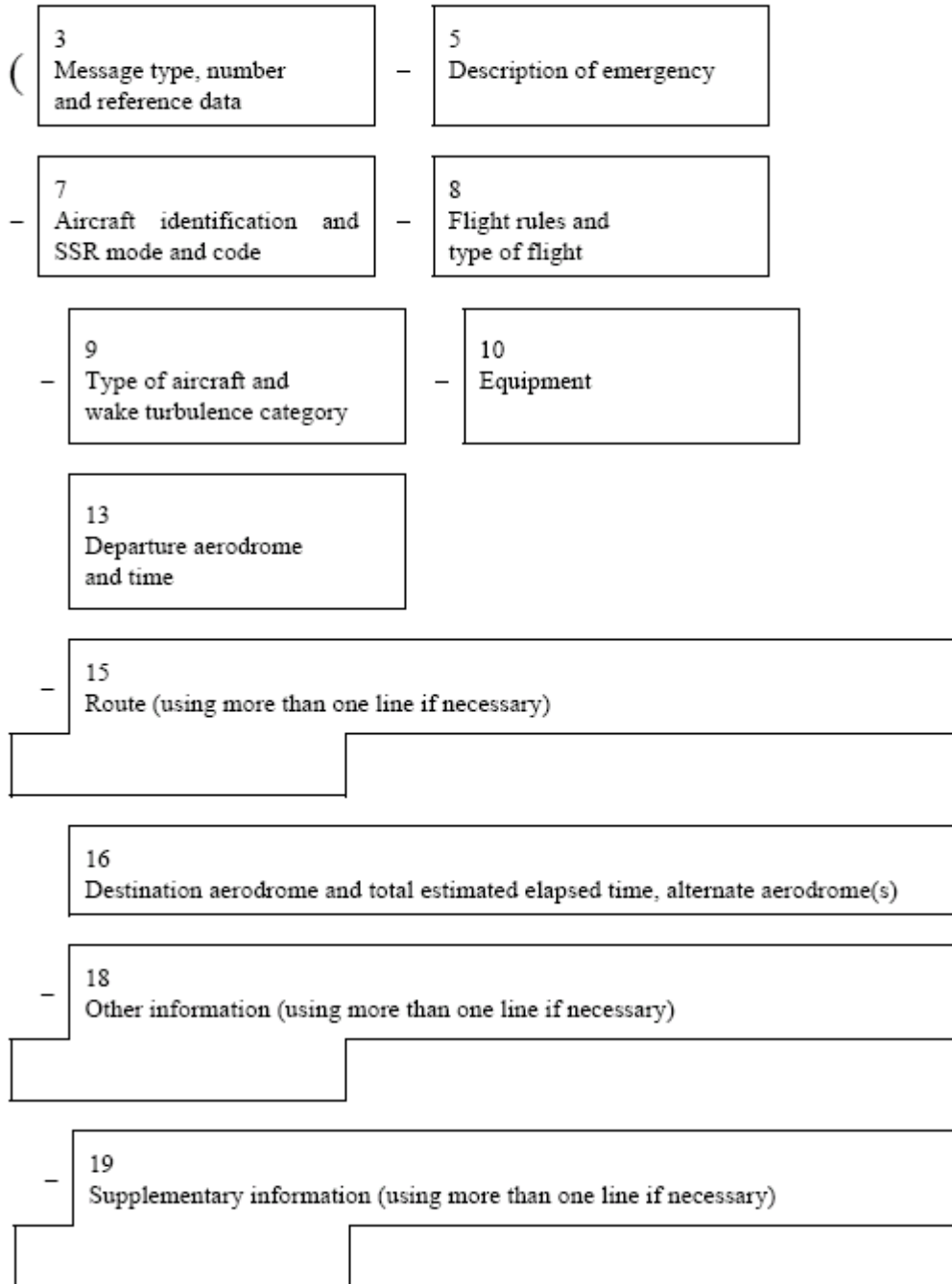

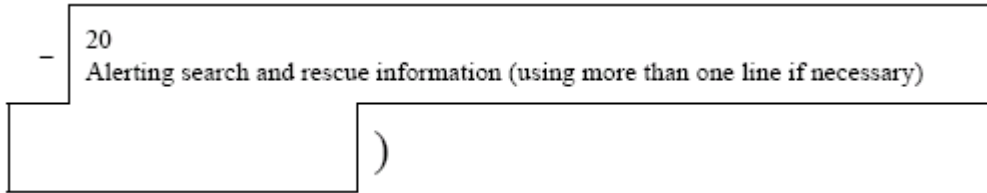

2.2.1.2 Example

The following is an example of an alerting message relating to an uncertainty phase, sent by Athens Approach Control to Belgrade Centre and other ATS units, in respect of a flight from Athens to Munich.

```
(ALR-INCERFA/LGGGZAZX/OVERDUE
-FOX236/A3624-IM
-C141/H-S/CD
-LGAT1020
-N0430F220 B9 3910N02230W/N0415F240 B9 IVA/N0415F180 B9
-EDDM0227 EDDF
-EET/LYBE0020 EDM10133 REG/A43213 OPR/USAF RMK/NO
POSITION REPORT SINCE DEP PLUS 2 MINUTES
-E/0720 P/12 R/UV J/LF D/02 014 C ORANGE A/SILVER C/SIGGAH
-USAF LGGGZAZX 1022 126.7 GN 1022 PILOT REPORT OVER NDB ATS
UNITS ATHENS FIR ALERTED NIL)
```

2.2.1.2.1 Meaning

Alerting message — uncertainty phase declared by Athens due no position reports and no radio contact since two minutes after departure — aircraft identification FOX236 — IFR, military flight — Starlifter, heavy wake turbulence category, equipped with standard communications, navigation and approach aid equipment for the route, SSR transponder with Modes A (4 096 code capability) and C — ADS capability — last assigned Code 3624 — departed Athens 1020 UTC — cruising speed for first portion of route 430 knots, first requested cruising level FL 220 — proceeding on airway Blue 9 to 3910N2230W where TAS would be changed to 415 knots — proceeding on airway Blue 9 to Ivanic Grad VOR where FL 180 would be requested, maintaining TAS of 415 knots — proceeding on airway Blue 9 to Munich, total estimated elapsed time 2 hours and 27 minutes — alternate is Frankfurt — accumulated estimated elapsed times at the Belgrade and Munich FIR boundaries 20 minutes and 1 hour and 33 minutes respectively — aircraft registration A43213 — the aircraft is operated by the USAF — no position report has been received since 2 minutes after departure — endurance 7 hours and 20 minutes after take-off — 12 persons on board — portable radio equipment working on VHF 121.5 MHz and UHF 243 MHz is carried — life jackets fitted with lights and fluorescein are carried — 2 dinghies with orange covers are carried, have a total capacity for 14 persons — aircraft colour is silver — pilot's name is SIGGAH — operator is USAF —

Athens approach control was the last unit to make contact at 1022 UTC on 126.7 MHz when pilot reported over GN runway locator beacon — Athens approach control have alerted all ATS units within Athens FIR — no other pertinent information.

2.2.2 Radiocommunication failure (RCF) message

2.2.2.1 Composition

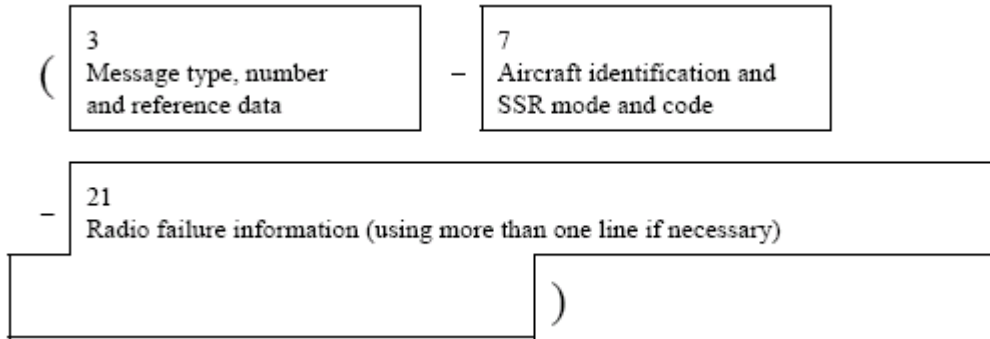

2.2.2.2 Example

The following is an example of a message sent from London to Amsterdam informing that centre of a radiocommunication failure on a flight that has been cleared to it. The related flight plan shows that the aircraft is not equipped with an SSR transponder.

(RCF-GAGAB
-1231 121.3 CLA 1229 TRANSMITTING ONLY 126.7 MHZ LAST POSITION
CONFIRMED BY RADAR)

2.2.2.2.1 Meaning

Radiocommunication failure message — aircraft identification GAGAB — no SSR code assigned — last communication with London Centre 1232 UTC on 121.3 MHz — last reported position was Clacton VOR, at 1229 UTC — remaining COM capability: last heard transmitting on 126.7 MHz — position report at Clacton observed by radar.

2.3 Filed flight plan and associated update messages

2.3.1 Filed flight plan (FPL) message

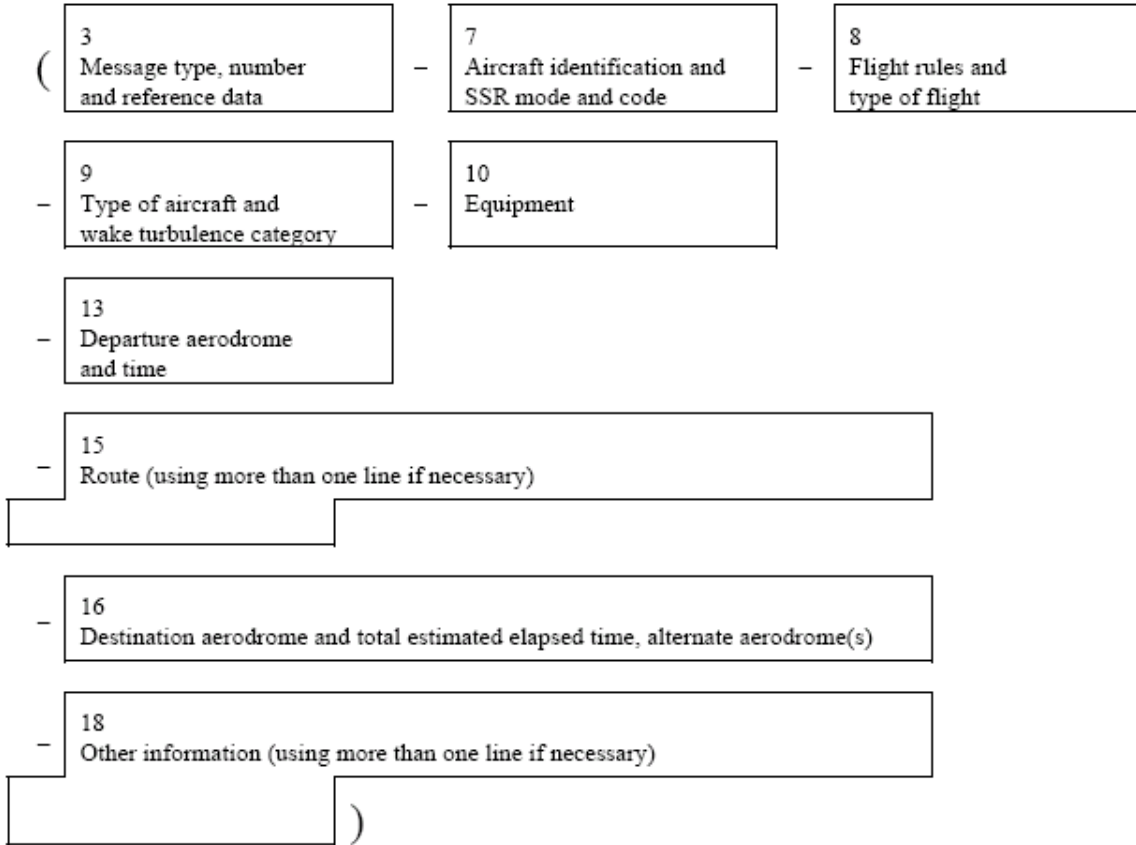

2.3.1.2 Example

The following is an example of a filed flight plan message sent by London Airport to Shannon, Shanwick and Gander Centres. The message may also be sent to the London Centre or the data may be passed to that centre by voice.

```
(FPL-TPR101-IS
-B707M-CHOPV/CD
-EGLL1400
-N0450F310 G1 UG1 STU285036/M082F310 UG1 52N015W
52N020W 52N030W 50N040W 49N050W
-CYQX0455 CYXR
-EET/EINN0026 EGGX0111 20W0136 CYQX0228 40W0330 50W0415 SEL/FJEL)
```

2.3.1.2.1 *Meaning*

Filed flight plan message — aircraft identification TPR101 — IFR, scheduled flight — a Boeing 707, medium wake turbulence category equipped with Loran C, HF RTF, VOR, Doppler, VHF RTF and SSR transponder with Modes A (4096 code capability) and C — ADS capability — departure aerodrome is London, estimated off-block time 1400 UTC — cruising speed and requested flight level for the first portion of the route are 450 knots and FL 310 — the flight will proceed on Airways Green 1 and Upper Green 1 to a point bearing 285 degrees magnetic and 36 NM from the Strumble VOR. From this point the flight will fly at a constant Mach number of .82, proceeding on Upper Green 1 to 52N15W; then to 52N20W; to 52N30W; to 50N40W; to 49N50W; to destination Gander, total estimated elapsed time 4 hours and 55 minutes — alternate is Goose Bay — captain has notified accumulated estimated elapsed times at significant points along the route, they are at the Shannon FIR boundary 26 minutes, at the Shanwick Oceanic FIR boundary 1 hour and 11 minutes, at 20W 1 hour and 36 minutes, at the Gander Oceanic FIR boundary 2 hours and 28 minutes, at 40W 3 hours and 30 minutes and at 50W 4 hours and 15 minutes — SELCAL code is FJEL.

2.3.2 *Modification (CHG) message*

2.3.2.1 *Composition*

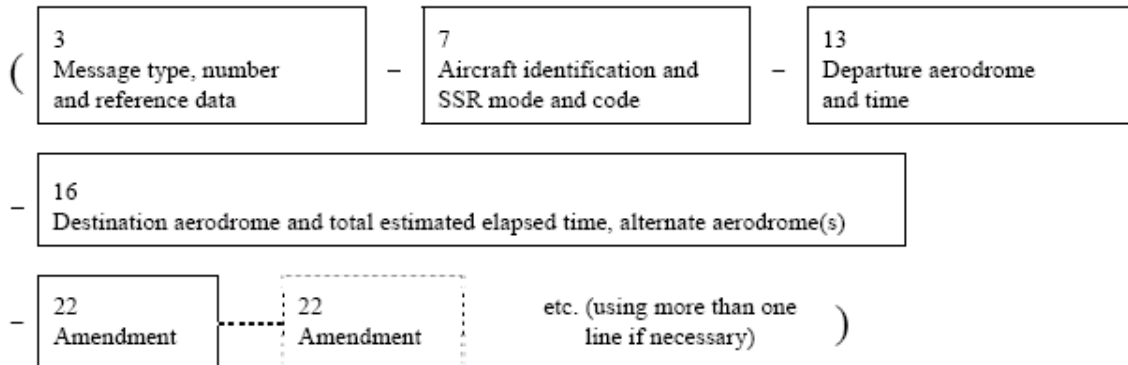

2.3.2.2 *Example*

The following is an example of a modification message sent by Amsterdam Centre to Frankfurt Centre correcting information previously sent to Frankfurt in a filed flight plan message. It is assumed that both centres are computer-equipped.

(CHGA/F016A/F014-GABWE/A2173-EHAM-EDDF-8/I-16/EDDN)

2.3.2.2.1 *Meaning*

Modification message — Amsterdam and Frankfurt computer unit identifiers A and F, followed by serial number (016) of this message sent by Amsterdam, repeat of computer unit identifiers followed by serial number (014) of the related filed flight plan message — aircraft identification GABWE, SSR Code 2173 operating in Mode A, en route from Amsterdam to Frankfurt — Field Type 8 of the related filed flight plan message is corrected to IFR — Field Type 16 of the related filed flight plan is corrected, the new destination is Nürnberg.

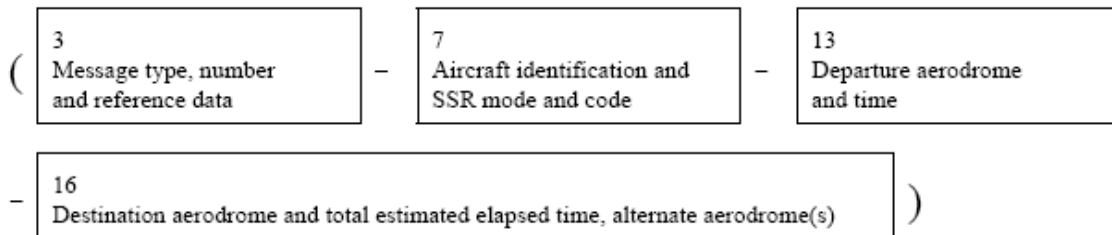
2.3.3 *Flight plan cancellation (CNL) message*2.3.3.1 *Composition*2.3.3.2 *Example 1*

The following is an example of a flight plan cancellation message sent by an ATS unit to all addressees of a filed flight plan message previously sent by that unit.

(CNL-DLH522-EDBB-LFPO)

2.3.3.2.1 *Meaning*

Flight plan cancellation message — cancel the flight plan of aircraft identification DLH522 — flight planned from Berlin to Paris.

2.3.3.3 *Example 2*

The following is an example of a flight plan cancellation message sent by a centre to an adjacent centre. It is assumed that both centres are equipped with ATC computers.

(CNLF/B127F/B055-BAW580-EDDF-EDDW)

2.3.3.3.1 *Meaning*

Flight plan cancellation message — identifiers of sending and receiving ATC computer units F and B, followed by serial number (127) of this message, repeat of computer unit identifiers followed by serial number (055) of current flight plan message previously transmitted — cancel the flight plan of aircraft identification BAW580 — flight planned from Frankfurt to Bremen.

2.3.4 *Delay (DLA) message*

2.3.4.1 *Composition*

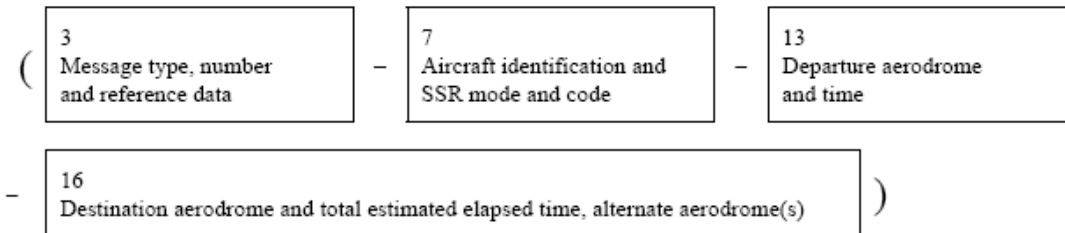

2.3.4.2 *Example*

The following is an example of a delay message sent from a departure aerodrome, or from a parent unit handling communications for a departure aerodrome, to each addressee of a filed flight plan message.

(DLA-KLM671-LIRF0900-LYDU)

2.3.4.2.1 *Meaning*

Delay message — aircraft identification KLM671 — revised estimated off-block time Fiumicino 0900 UTC destination Dubrovnik.

2.3.5 *Departure (DEP) message*

2.3.5.1 *Composition*

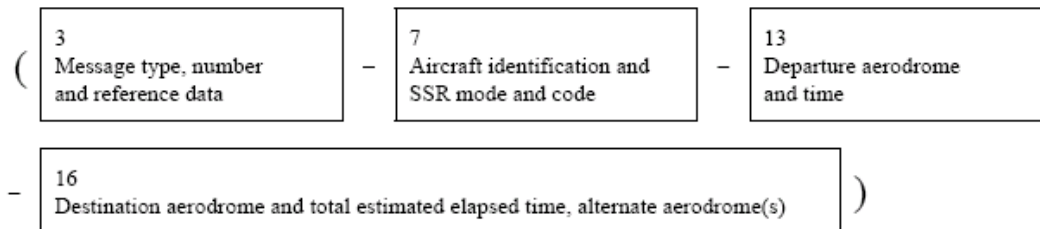

2.3.5.2 Example

The following is an example of a departure message sent from a departure aerodrome, or from a parent unit handling communications for a departure aerodrome, to each addressee of a filed flight plan message.

(DEP-CSA4311-EGPD1923-ENZV)

2.3.5.2.1 Meaning

Departure message — aircraft identification CSA4311 — departed from Aberdeen at 1923 UTC — destination Stavanger.

2.3.6 Arrival (ARR) message

2.3.6.1 Composition

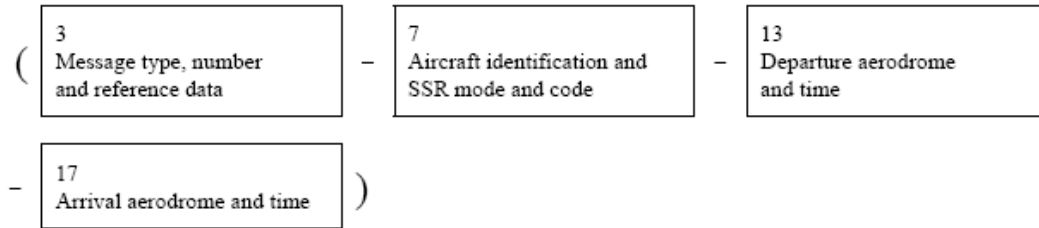

2.3.6.2 Example 1

The following is an example of an arrival message sent from the arrival aerodrome (= destination) to the departure aerodrome.

(ARR-CSA406-LHBP-LKPR0913)

2.3.6.2.1 Meaning

Arrival message — aircraft identification CSA406 — departed from Budapest/Ferihegy — landed at Prague/Ruzyne Airport at 0913 UTC.

2.3.6.3 Example 2

The following is an example of an arrival message sent for an aircraft which has landed at an aerodrome for which no ICAO location indicator has been allocated. The SSR code would not be meaningful.

(ARR-HELI13-EHAM-ZZZZ1030 DEN HELDER)

2.3.6.3.1 *Meaning*

Arrival message aircraft identification HELI13 — departed from Amsterdam — landed at Den Helder heliport at 1030 UTC.

2.4 Coordination messages

2.4.1 *Current flight plan (CPL) message*

2.4.1.1 *Composition*

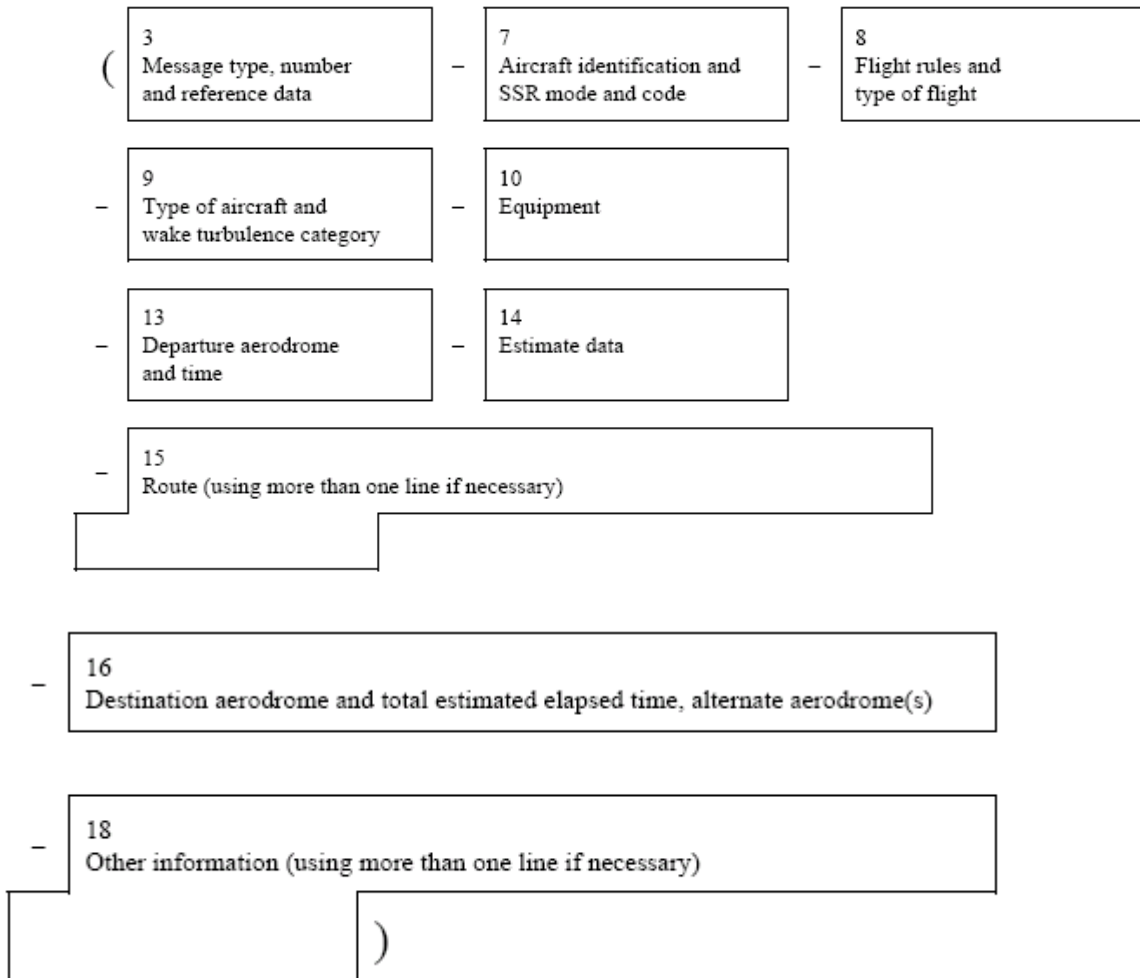

2.4.1.2 Example 1

The following is an example of a current flight plan message sent from Boston Centre to New York Centre on a flight which is en route from Boston to La Guardia Airport.

```
(CPL-UAL621/A5120-IS  
-DC9/M-S/CD  
-KBOS-HFD/1341A220A200A  
-N0420A220 V3 AGL V445  
-KLGA  
-0)
```

2.4.1.3 Example 2

The following is an example of the same current flight plan message, but in this case the message is exchanged between ATC computers.

```
(CPLBOS/LGA052-UAL621/A5120-IS  
-DC9/M-S/CD  
-KBOS-HFD/1341A220A200A  
-N0420A220 V3 AGL V445  
-KLGA  
-0)
```

Note.— The messages in Examples 1 and 2 are identical except that the Message Number of Example 2 does not appear in Example 1.

2.4.1.4 Meaning

Current flight plan message [with sending unit identity (BOS) and receiving unit identity (LGA), followed by the serial number of this message (052)] — aircraft identification UAL621, last assigned SSR Code 5120 in Mode A — IFR, scheduled flight — one DC9, medium wake turbulence category, equipped with standard communications, navigation and approach aid equipment for the route and SSR transponder with Modes A (4 096 code capability) and C — ADS capability — departed Boston — the flight is estimated to cross the Boston/New York “boundary” at point HFD at 1341 UTC, cleared by the Boston Centre at altitude 22 000 feet but to be at or above altitude 20 000 feet at HFD — TAS is 420 knots, requested cruising level is altitude 22 000 feet — the flight will proceed on airway V3 to reporting point AGL thence on airway V445 — destination is La Guardia Airport — no other information.

2.4.2 *Estimate (EST) message*

2.4.2.1 *Composition*

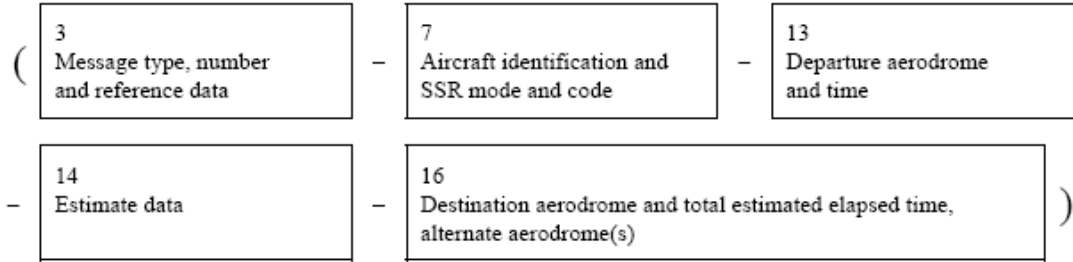

The following is an example of an estimate message sent from Paris Centre to London Centre. It is assumed that London Centre has received a filed flight plan message relating to this flight. Both centres are equipped with computers.

(ESTP/L027-BAW671/A5631-LFPG-ABB/1548F140F110A-EGLL)

2.4.2.2.1 *Meaning*

Estimate message [with sending unit identity (P) and receiving unit identity (L), followed by the serial number of this message (027)] — aircraft identification BAW671, last assigned SSR Code 5631 operating in Mode A — departure aerodrome Paris de Gaulle — estimating Abbeville VOR 1548 UTC, cleared FL 140, flight will cross the Abbeville VOR at FL 110 or above, ascending — destination aerodrome London.

2.4.3 *Coordination (CDN) message*

2.4.3.1 *Composition*

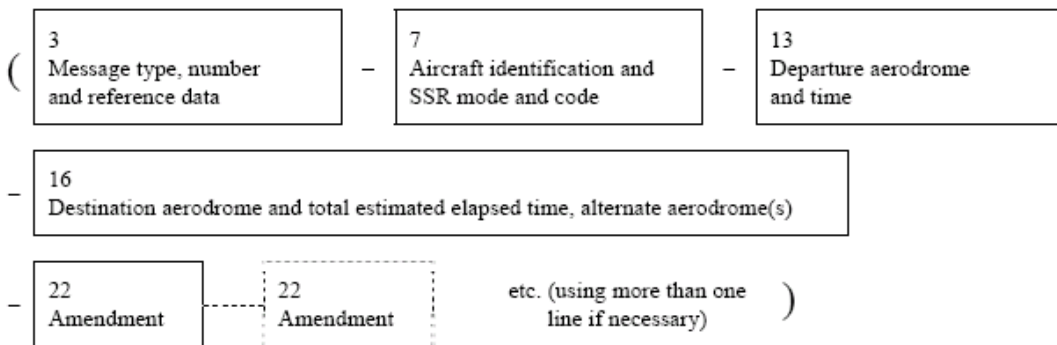

The following is an example of a coordination message sent from Prestwick Centre to Dublin Centre proposing changes to the conditions under which an aircraft should cross the Dublin/Prestwick boundary. Prestwick has received a current flight plan message from Dublin and both centres are equipped with ATC computers.

(CDNP/D098D/P036-BAW617/A5136-EIDW-EGPK-14/GRN/1735F210F130A)

2.4.3.2.1 *Meaning*

Coordination message — Prestwick and Dublin ATC computer unit identifiers, P and D, followed by serial number (098) of this message sent by Prestwick, followed by analogous data identifying the current flight plan message sent from Dublin to which it is related (D/P036) — aircraft identification BAW617/SSR Code 5136 operating in Mode A — en route from Dublin to Prestwick — Field Type 14 is the subject of the proposal, i.e. Prestwick will accept the flight at the boundary point GRN at 1735 UTC and crossing the boundary point at or above FL 130 climbing to a cleared level of FL 210.

2.4.4 *Acceptance (ACP) message*

2.4.4.1 *Composition*

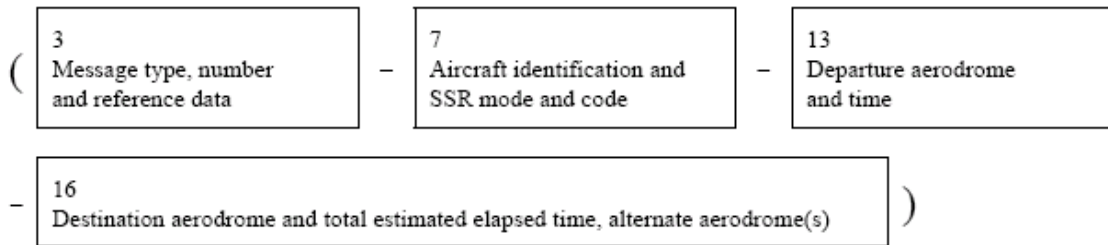

2.4.4.2 *Example*

The following is an example of an acceptance message sent from London Centre to Paris Centre relating to a current flight plan message which London has received from Paris. It is assumed that both centres are equipped with ATC computers.

(ACPL/P086P/L142-EIN065/A4570-LFPO-EGLL)

2.4.4.2.1 *Meaning*

Acceptance message — London and Paris computer unit identifiers, L and P, followed by serial number (086) of this message sent by London, followed by analogous data identifying the current flight plan message sent from Paris, to which it is related (PL142) — aircraft identification EIN065/SSR Code 4570 operating in Mode A — en route from Paris to London — is acceptable.

2.4.5 Logical acknowledgement (LAM) message

2.4.5.1 Composition

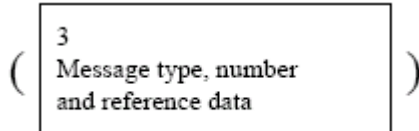

2.4.5.2 Example

The following is an example of a logical acknowledgement message sent by a centre to an adjacent centre reacting to a current flight plan message. It is assumed that both centres are equipped with ATC computers.

(LAMP/M178M/P100)

2.4.5.2.1 Meaning

Logical acknowledgement message — identifiers of sending and receiving ATC computer units Paris and Maastricht, followed by the sending unit serial number (178) of this message, followed by the computer unit identifiers and serial number (100) of the related estimate message.

2.5 Supplementary messages

2.5.1 Request flight plan (RQP) message

2.5.1.1 Composition

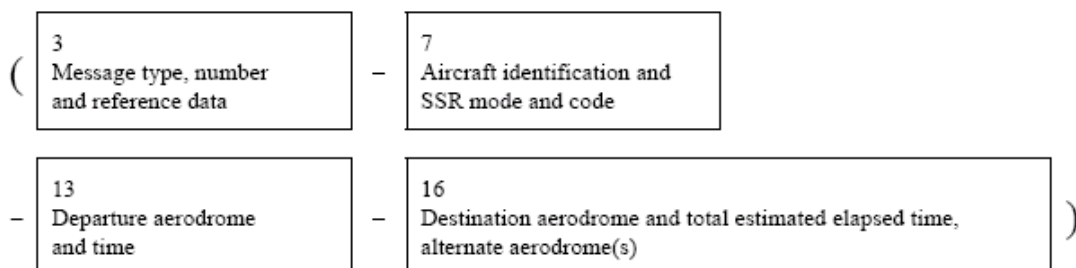

2.5.1.2 *Example*

The following is an example of a request flight plan message sent by a centre to an adjacent centre after receipt of an estimate message, for which no corresponding filed flight plan message had been received previously.

(RQP-PHOEN-EHRD-EDDL)

2.5.1.2.1 *Meaning*

Request flight plan message — aircraft identification PHOEN departed from Rotterdam — destination Düsseldorf.

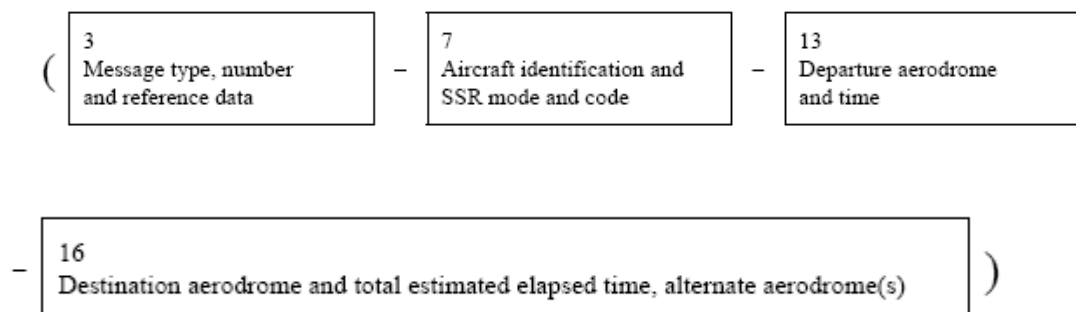
2.5.2 *Request supplementary flight plan (RQS) message*2.5.2.1 *Composition*2.5.2.2 *Example*

The following is an example of a request supplementary flight plan message sent by an ATS unit to the ATS unit serving the departure aerodrome requesting information contained in the flight plan form, but not transmitted in the filed or current flight plan messages.

(RQS-KLM405/A4046-EHAM-CYMX)

2.5.2.2.1 *Meaning*

Request supplementary flight plan message — aircraft identification KLM405/SSR Code 4046 operating in Mode A — departure aerodrome is Amsterdam — destination aerodrome is Mirabel.

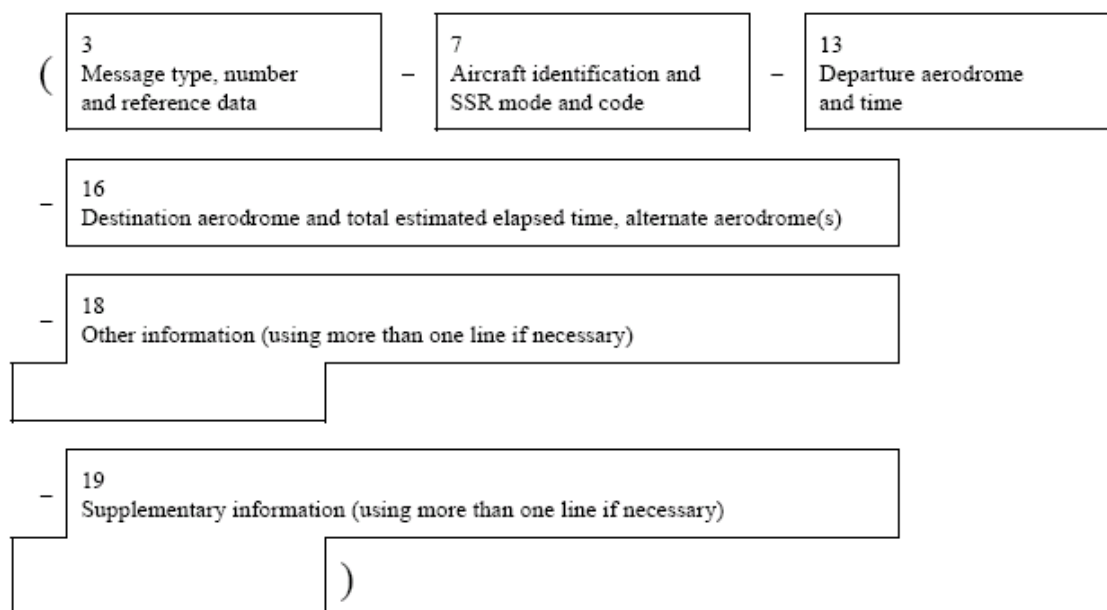
2.5.3 *Supplementary flight plan (SPL) message*2.5.3.1 *Composition*2.5.3.2 *Example*

The following is an example of a supplementary flight plan message sent by the departure aerodrome of a flight to an ATS unit which had requested supplementary information recorded on the flight plan form (but not transmitted in filed flight plan messages or current flight plan messages).

```

(SPL-SAW502A
-EDDW0920
-EKCH0400 EKVB
-REG/GBZTA RMK/CHARTER
-E/0640 P/9 R/V J/L A/BLUE C/DENKE)

```

2.5.3.2.1 *Meaning*

Supplementary flight plan message — aircraft identification SAW502A no SSR — departed Bremen 0920 UTC — destination Kastrup, total estimated elapsed time 4 hours — alternate Viborg — aircraft registration GBZTA — charter flight — endurance 6 hours and 40 minutes after departure — 9 persons on board — portable radio working on International Distress Frequency 121.5 MHz is carried — life jackets fitted with lights are carried — the aircraft colour is blue — the pilot's name is Denke.

APPENDIX 4

AIR TRAFFIC INCIDENT REPORT

- 1 Air traffic incident report form
- 2 Instructions for the completion of the air traffic incident report form

1 Air traffic incident report form

For use when submitting and receiving reports on air traffic incidents. In an initial report by radio, shaded items should be included.

A - AIRCRAFT IDENTIFICATION [Shaded area for aircraft identification]	B - TYPE OF INCIDENT [Shaded area for type of incident] AIRPROX / PROCEDURE / FACILITY*
---	--

C - THE INCIDENT

1.	General	[Shaded area]
a)	Date / time of incident	[Shaded area] UTC [Shaded area]
b)	Position	[Shaded area]

2.	Own aircraft	[Shaded area]
a)	Heading and route	[Shaded area]
b)	True airspeed	[Shaded area] measured in <input type="checkbox"/> kt <input type="checkbox"/> km/h
c)	Level and altimeter setting	[Shaded area] / [Shaded area]
d)	Aircraft climbing or descending	<input type="checkbox"/> Level flight <input type="checkbox"/> Climbing <input type="checkbox"/> Descending
e)	Aircraft bank angle	<input type="checkbox"/> Wings level <input type="checkbox"/> Slight bank <input type="checkbox"/> Moderate bank <input type="checkbox"/> Steep bank <input type="checkbox"/> Inverted <input type="checkbox"/> Unknown
f)	Aircraft direction of bank	<input type="checkbox"/> Left <input type="checkbox"/> Right <input type="checkbox"/> Unknown
g)	Restrictions to visibility (select as many as required)	<input type="checkbox"/> Sunglare <input type="checkbox"/> Windscreen pillar <input type="checkbox"/> Dirty windscreen <input type="checkbox"/> Other cockpit structure <input type="checkbox"/> None
h)	Use of aircraft lighting (select as many as required)	<input type="checkbox"/> Navigation lights <input type="checkbox"/> Strobe lights <input type="checkbox"/> Cabin lights <input type="checkbox"/> Red anti-collision lights <input type="checkbox"/> Landing / taxi lights <input type="checkbox"/> Logo (tail fin) lights <input type="checkbox"/> Other <input type="checkbox"/> None
i)	Traffic avoidance advice issued by ATS	<input type="checkbox"/> Yes, based on radar <input type="checkbox"/> Yes, based on visual sighting <input type="checkbox"/> Yes, based on other information <input type="checkbox"/> No
j)	Traffic information issued	<input type="checkbox"/> Yes, based on radar <input type="checkbox"/> Yes, based on visual sighting <input type="checkbox"/> Yes, based on other information <input type="checkbox"/> No
k)	Airborne collision avoidance system - ACAS	<input type="checkbox"/> Not carried <input type="checkbox"/> Type <input type="checkbox"/> Traffic advisory issued <input type="checkbox"/> Resolution advisory issued <input type="checkbox"/> Traffic advisory or resolution advisory not issued

l)	Radar identification	<input type="checkbox"/> No radar available	<input type="checkbox"/> Radar identification	<input type="checkbox"/> No radar identification
m)	Other aircraft sighted	<input type="checkbox"/> Yes	<input type="checkbox"/> No	<input type="checkbox"/> Wrong aircraft sighted
n)	Avoiding action taken	<input type="checkbox"/> Yes	<input type="checkbox"/> No	
o)	Type of flight plan	<input type="checkbox"/> IFR	<input type="checkbox"/> VFR	<input type="checkbox"/> none*

3. Other aircraft				
a)	Type and call sign / registration (if known)			
b)	If a) above not known, describe below			
	<input type="checkbox"/> High wing	<input type="checkbox"/> Mid wing	<input type="checkbox"/> Low wing	
	<input type="checkbox"/> Rotorcraft			
	<input type="checkbox"/> 1 engine	<input type="checkbox"/> 2 engines	<input type="checkbox"/> 3 engines	
	<input type="checkbox"/> 4 engines	<input type="checkbox"/> More than 4 engines		
Making, colour or other available details				
c)	Aircraft climbing or descending			
	<input type="checkbox"/> Level flight	<input type="checkbox"/> Climbing	<input type="checkbox"/> Descending	
	<input type="checkbox"/> Unknown			
d)	Aircraft bank angle			
	<input type="checkbox"/> Wings level	<input type="checkbox"/> Slight bank	<input type="checkbox"/> Moderate bank	
	<input type="checkbox"/> Steep bank	<input type="checkbox"/> Inverted	<input type="checkbox"/> Unknown	
e)	Aircraft direction of bank			
	<input type="checkbox"/> Left	<input type="checkbox"/> Right	<input type="checkbox"/> Unknown	
f)	Lights displayed			
	<input type="checkbox"/> Navigation lights	<input type="checkbox"/> Strobe lights	<input type="checkbox"/> Cabin lights	
	<input type="checkbox"/> Red anti-collision lights	<input type="checkbox"/> Landing / taxi lights	<input type="checkbox"/> Logo (tail fin) lights	
	<input type="checkbox"/> Other	<input type="checkbox"/> None	<input type="checkbox"/> Unknown	
g)	Traffic avoidance advice issued by ATS			
	<input type="checkbox"/> Yes, based on radar	<input type="checkbox"/> Yes, based on visual sighting	<input type="checkbox"/> Yes, based on other information	
	<input type="checkbox"/> No	<input type="checkbox"/> Unknown		
h)	Traffic information issued			
	<input type="checkbox"/> Yes, based on radar	<input type="checkbox"/> Yes, based on visual sighting	<input type="checkbox"/> Yes, based on other information	
	<input type="checkbox"/> No	<input type="checkbox"/> Unknown		
i)	Avoiding action taken			
	<input type="checkbox"/> Yes	<input type="checkbox"/> No	<input type="checkbox"/> Unknown	

4. Distance
a) Closest horizontal distance
b) Closest vertical distance
5. Flight weather conditions
a) <input type="checkbox"/> IMC / <input type="checkbox"/> VMC*
b) <input type="checkbox"/> Above / <input type="checkbox"/> below* clouds <input type="checkbox"/> fog <input type="checkbox"/> haze or <input type="checkbox"/> between layers*
c) Distance vertically from cloud _____ m / ft* below _____ m / ft* above
d) <input type="checkbox"/> In cloud <input type="checkbox"/> rain <input type="checkbox"/> snow <input type="checkbox"/> sleet <input type="checkbox"/> fog <input type="checkbox"/> haze*
e) Flying <input type="checkbox"/> into <input type="checkbox"/> out of* sun
f) Flight visibility _____ m / km*
6. Any other information considered important by the pilot-in-command

D – MISCELLANEOUS

1. Information regarding reporting aircraft
a) Aircraft registration
b) Aircraft type
c) Operator
d) Aerodrome of departure
e) Aerodrome of first landing _____ Destination _____
f) Reported by radio or other means to _____ (name of ATS unit) at time _____ UTC
g) Date / time / place of completion of form _____
2. Function, address and signature of person submitting report
a) Function
b) Address
c) Signature
d) Telephone number
3. Function and signature of person receiving report
a) Function _____ b) Signature _____

E - SUPPLEMENTARY INFORMATION BY ATS UNIT CONCERNED

1. Receipt of report
a) Report received via AFTN / radio / telephone / other (specify)* _____
b) Report received by _____ (name of ATS unit)
2. Details of ATS action
Clearance, incident seen (radar/visually, warning given, result of local enquiry, etc)

DIAGRAMS OF AIRPROX

Mark passage of other aircraft relative to you, in plan on the left and in elevation on the right, assuming YOU are at the centre of each diagram. Include first sighting and passing distance.

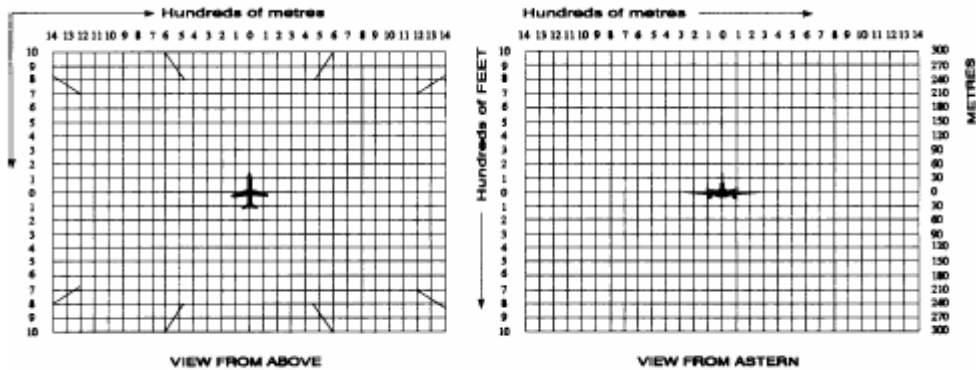

Instructions for the completion of the Air Traffic Incident Report Form.

Item

- A. Aircraft identification of the aircraft filing the report.
- B. An AIRPROX report should be filed immediately by radio.
- C1. Date/time UTC and position in bearing and distance from a navigation aid or in LAT/LONG.
- C2. Information regarding aircraft filing the report, tick as necessary.
- C2. c. E.g. FL350/1013 hPa or 2500 ft/QNH1007 hPa or 1200 ft/QFE 998 hPa.
- C3. Information regarding the other aircraft involved.
- C4. Passing distance - state units used.
- C6. Attach additional papers as required. The diagrams may be used to show aircraft's positions.
- D1. f. State the name of ATS unit and date/time in UTC.
- D1. g. Date and time in UTC.
- E2 Include details of ATS unit such as service provided, radiotelephony frequency, SSR Codes assigned and altimeter setting. Use diagram to show the aircraft's position and attach additional papers as necessary.

APPENDIX 5A

FANs-1/A CPDLC MESSAGE SET AND INTENT

This Section contains a complete listing of the message intent for all FANs-1/A CPDLC messages

1. Response Requirements Key:

TYPE	CLOSURE RESPONSE
W/U	WILCO, UNABLE, will close the uplink message
A/N	AFFIRM, NEGATIVE, will close the uplink message
R	ROGER, will close the uplink message,
NE	Most messages with an NE attribute require an operational response. Only the correct operational response is presented to the pilot. The uplink message is considered to be closed on sending and does not require a response to close the dialogue. The WILCO, UNABLE, AFFIRM, NEGATIVE, ROGER and STANDBY responses are not enabled for pilot selection.
Y	Response required.
N	Response not required.

Note: Under some circumstances. An ERROR message will also close an uplink message.

Multi element uplink messages require only a single closure response. The response required for a multi element message is the highest priority response out of each of the elements in the message. When determining the highest priority, the following priority order is used:

W/U
A/N
R
NE

For example, the uplink CLIMB TO AND MAINTAIN FL370. REPORT LEVEL FL370 contains two elements. The first element requires a “W/U” response, the second an “R” response. The highest priority response is W/U, therefore this is the response required for closure.

2 Uplink - Responses and Acknowledgements

UM	MESSAGE ELEMENT	MESSAGE INTENT	RESPONSE
0	UNABLE	Indicates that ATS cannot comply with the request	NE
1	STANDBY	Indicates that ATS has received the message and will respond. <i>The pilot is informed that the request is being assessed and there will be a short-term delay (within 10 minutes). The exchange is not closed and the request will be responded to when conditions allow.</i>	NE
2	REQUEST DEFERRED	Indicates that ATS has received the request but it has been deferred until later. <i>The pilot is informed that the request is being assessed and a long-term delay can be expected. The exchange is not closed and the request will be responded to when conditions allow.</i>	NE
3	ROGER	Indicates that ATS has received and understood the message..	NE
4	AFFIRM	Yes	NE
5	NEGATIVE	No	NE

3 Uplink - Vertical Clearances

UM	MESSAGE ELEMENT	MESSAGE INTENT	RESPONSE
6	EXPECT [altitude]	Notification that a level change instruction should be expected.	R
7	EXPECT CLIMB AT [time]	Notification that an instruction should be expected for the aircraft to commence climb at the specified time.	R
8	EXPECT CLIMB AT [position]	Notification that an instruction should be expected for the aircraft to commence climb at the specified position.	R
9	EXPECT DESCENT AT [time]	Notification that an instruction should be expected for the aircraft to commence descent at the specified time.	R
10	EXPECT DESCENT AT [position]	Notification that an instruction should be expected for the aircraft to commence descent at the specified position.	R
11	EXPECT CRUISE CLIMB AT [time]	Notification that an instruction should be expected for the aircraft to commence cruise climb at the specified time. <i>Due to different interpretations between the various ATS units this element should be avoided.</i>	R

UM	MESSAGE ELEMENT	MESSAGE INTENT	RESPONSE
12	EXPECT CRUISE CLIMB AT [position]	Notification that an instruction should be expected for the aircraft to commence cruise climb at the specified position. <i>Due to different interpretations between the various ATS units this element should be avoided.</i>	R
13	AT [time] EXPECT CLIMB TO [altitude]	Notification that an instruction should be expected for the aircraft to commence climb at the specified time to the specified level.	R
14	AT [position] EXPECT CLIMB TO [altitude]	Notification that an instruction should be expected for the aircraft to commence climb at the specified position to the specified level.	R
15	AT [time] EXPECT DESCENT TO [altitude]	Notification that an instruction should be expected for the aircraft to commence descent at the specified time to the specified level.	R
16	AT [position] EXPECT DESCENT TO [altitude]	Notification that an instruction should be expected for the aircraft to commence descent at the specified position to the specified level.	R
17	AT [time] EXPECT CRUISE CLIMB TO [altitude]	Notification that an instruction should be expected for the aircraft to commence cruise climb at the specified time to the specified level. <i>Due to different interpretations between the various ATS units, this element should be avoided.</i>	R
18	AT [position] EXPECT CRUISE CLIMB TO [altitude]	Notification that an instruction should be expected for the aircraft to commence cruise climb at the specified position to the specified level. <i>Due to different interpretations between the various ATS units, this element should be avoided.</i>	R
19	MAINTAIN [altitude]	Instruction to maintain the specified level.	W/U
20	CLIMB TO AND MAINTAIN [altitude]	Instruction that a climb to the specified level is to commence and the level is to be maintained when reached.	W/U
21	AT [time] CLIMB TO AND MAINTAIN [altitude]	Instruction that at the specified time, a climb to the specified level is to commence and once reached the specified level is to be maintained.	W/U

UM	MESSAGE ELEMENT	MESSAGE INTENT	RESPONSE
22	AT [position] CLIMB TO AND MAINTAIN [altitude]	Instruction that at the specified position, a climb to the specified level is to commence and once reached the specified level is to be maintained.	W/U
23	DESCEND TO AND MAINTAIN [altitude]	Instruction that a descent to the specified level is to commence and the level is to be maintained when reached.	W/U
24	AT [time] DESCEND TO AND MAINTAIN [altitude]	Instruction that at the specified time a descent to the specified level is to commence and once reached the specified level is to be maintained.	W/U
25	AT [position] DESCEND TO AND MAINTAIN [altitude]	Instruction that at the specified position a descent to the specified level is to commence and when the specified level is reached it is to be maintained.	W/U
26	CLIMB TO REACH [altitude] BY [time]	Instruction that a climb is to commence at a rate such that the specified level is reached at or before the specified time. <i>When this element is not combined with another vertical clearance the altitude specified is the assigned level.</i>	W/U
27	CLIMB TO REACH [altitude] BY [position]	Instruction that a climb is to commence at a rate such that the specified level is reached at or before the specified position. <i>When this element is not combined with another vertical clearance the altitude specified is the assigned level.</i>	W/U
28	DESCEND TO REACH [altitude] BY [time]	Instruction that a descent is to commence at a rate such that the specified level is reached at or before the specified time. <i>When this element is not combined with another vertical clearance the altitude specified is the assigned level</i>	W/U
29	DESCEND TO REACH [altitude] BY [position]	Instruction that a descent is to commence at a rate such that the specified level is reached at or before the specified position. <i>When this element is not combined with another vertical clearance the altitude specified is the assigned level.</i>	W/U
30	MAINTAIN BLOCK [altitude] TO [altitude]	A level within the specified vertical range is to be maintained.	W/U

UM	MESSAGE ELEMENT	MESSAGE INTENT	RESPONSE
31	CLIMB TO AND MAINTAIN BLOCK [altitude] TO [altitude]	Instruction that a climb to a level within the specified vertical range is to commence.	W/U
32	DESCEND TO AND MAINTAIN BLOCK [altitude] TO [altitude]	Instruction that a descent to a level within the specified vertical range is to commence.	W/U
33	CRUISE [altitude]	Instruction that authorizes a pilot to conduct flight at any altitude from the minimum altitude up to and including the altitude specified in the clearance. Further, it is approval for the pilot to proceed to and make an approach at the destination airport. <i>Due to different interpretations between the various ATS units, this element should be avoided.</i>	
34	CRUISE CLIMB TO [altitude]	A cruise climb is to commence and continue until the specified level is reached. <i>Due to different interpretations between the various ATS units, this element should be avoided.</i>	W/U
35	CRUISE CLIMB ABOVE [altitude]	A cruise climb can commence once above the specified level. <i>Due to different interpretations between the various ATS units, this element should be avoided.</i>	W/U
36	EXPEDITE CLIMB TO [altitude]	The climb to the specified level should be made at the aircraft's best rate.	W/U
37	EXPEDITE DESCENT TO [altitude]	The descent to the specified level should be made at the aircraft's best rate.	W/U
38	IMMEDIATELY CLIMB TO [altitude]	Urgent instruction to immediately climb to the specified level.	W/U
39	IMMEDIATELY DESCEND TO [altitude]	Urgent instruction to immediately descend to the specified level.	W/U
40	IMMEDIATELY STOP CLIMB AT [altitude]	Urgent instruction to immediately stop a climb once the specified level is reached.	W/U
41	IMMEDIATELY STOP DESCENT AT [altitude]	Urgent instruction to immediately stop a descent once the specified level is reached.	W/U

UM	MESSAGE ELEMENT	MESSAGE INTENT	RESPONSE
171	CLIMB AT [vertical rate] MINIMUM	Instruction to climb at not less than the specified rate.	W/U
172	CLIMB AT [vertical rate] MAXIMUM	Instruction to climb at not above the specified rate.	W/U
173	DESCEND AT [vertical rate] MINIMUM	Instruction to descend at not less than the specified rate.	W/U
174	DESCEND AT [vertical rate] MAXIMUM	Instruction to descend at not above the specified rate.	W/U

4 Uplink - Crossing Constraints

42	EXPECT TO CROSS [position] AT [altitude]	Notification that a level change instruction should be expected which will require the specified position to be crossed at the specified level.	R
43	EXPECT TO CROSS [position] AT OR ABOVE [altitude]	Notification that a level change instruction should be expected which will require the specified position to be crossed at or above the specified level.	R
44	EXPECT TO CROSS [position] AT OR BELOW [altitude]	Notification that a level change instruction should be expected which will require the specified position to be crossed at or below the specified level.	R
45	EXPECT TO CROSS [position] AT AND MAINTAIN [altitude]	Notification that a level change instruction should be expected which will require the specified position to be crossed at the specified level which is to be maintained subsequently.	R
46	CROSS [position] AT [altitude]	The specified position is to be crossed at the specified level. This may require the aircraft to modify its climb or descent profile.	W/U
47	CROSS [position] AT OR ABOVE [altitude]	The specified position is to be crossed at or above the specified level.	W/U

UM	MESSAGE ELEMENT	MESSAGE INTENT	RESPONSE
48	CROSS [position] AT OR BELOW [altitude]	The specified position is to be crossed at or below the specified level.	W/U
49	CROSS [position] AT AND MAINTAIN [altitude]	Instruction that the specified position is to be crossed at the specified level and that level is to be maintained when reached.	W/U
50	CROSS [position] BETWEEN [altitude] AND [altitude]	The specified position is to be crossed at a level between the specified levels.	W/U
51	CROSS [position] AT [time]	The specified position is to be crossed at the specified time.	W/U
52	CROSS [position] AT OR BEFORE [time]	The specified position is to be crossed at or before the specified time.	W/U
53	CROSS [position] AT OR AFTER [time]	The specified position is to be crossed at or after the specified time.	W/U
54	CROSS [position] BETWEEN [time] AND [time]	The specified position is to be crossed at a time between the specified times.	W/U
55	CROSS [position] AT [speed]	The specified position is to be crossed at the specified speed and the specified speed is to be maintained until further advised.	W/U
56	CROSS [position] AT OR LESS THAN [speed]	The specified position is to be crossed at a speed equal to or less than the specified speed and the specified speed or less is to be maintained until further advised.	W/U
57	CROSS [position] AT OR GREATER THAN [speed]	The specified position is to be crossed at a speed equal to or greater than the specified speed and the specified speed or greater is to be maintained until further advised.	W/U
58	CROSS [position] AT [time] AT [altitude]	The specified position is to be crossed at the specified time and the specified level.	W/U

UM	MESSAGE ELEMENT	MESSAGE INTENT	RESPONSE
59	CROSS [position] AT OR BEFORE [time] AT [altitude]	The specified position is to be crossed at or before the specified time and at the specified level.	W/U
60	CROSS [position] AT OR AFTER [time] AT [altitude]	The specified position is to be crossed at or after the specified time and at the specified level.	W/U
61	CROSS [position] AT AND MAINTAIN [altitude] AT [speed]	Instruction that the specified position is to be crossed at the specified level and speed and the level and speed are to be maintained.	W/U
62	AT [time] CROSS [position] AT AND MAINTAIN [altitude]	Instruction that at the specified time the specified position is to be crossed at the specified level and the level is to be maintained.	W/U
63	AT [time] CROSS [position] AT AND MAINTAIN [altitude] AT [speed]	Instruction that at the specified time the specified position is to be crossed at the specified level and speed and the level and speed are to be maintained.	W/U

5 Uplink - Lateral Offsets

UM	MESSAGE ELEMENT	MESSAGE INTENT	RESPONSE
64	OFFSET [direction] [distance offset] OF ROUTE	Instruction to fly a parallel track to the cleared route at a displacement of the specified distance in the specified direction.	W/U
65	AT [position] OFFSET [direction] [distance offset] OF ROUTE	Instruction to fly a parallel track to the cleared route at a displacement of the specified distance in the specified direction and commencing at the specified position.	W/U
66	AT [time] OFFSET [direction] [distance offset] OF ROUTE	Instruction to fly a parallel track to the cleared route at a displacement of the specified distance in the specified direction and commencing at the specified time.	W/U
67	PROCEED BACK ON ROUTE	The cleared flight route is to be rejoined.	W/U
68	REJOIN ROUTE BY [position]	The cleared flight route is to be rejoined at or before the specified position.	W/U
69	REJOIN ROUTE BY [time]	The cleared flight route is to be rejoined at or before the specified time.	W/U
70	EXPECT BACK ON ROUTE BY [position]	Notification that a clearance may be issued to enable the aircraft to rejoin the cleared route at or before the specified position.	R
71	EXPECT BACK ON ROUTE BY [time]	Notification that a clearance may be issued to enable the aircraft to rejoin the cleared route at or before the specified time.	R
72	RESUME OWN NAVIGATION	Instruction to resume own navigation following a period of tracking or heading clearances. May be used in conjunction with an instruction on how or where to rejoin the cleared route.	W/U

6 Uplink - Route Modifications

73	[predepartureclearance]	Notification to the aircraft of the instructions to be followed from departure until the specified clearance limit.	W/U
74	PROCEED DIRECT TO [position]	Instruction to proceed directly from the present position to the specified position.	W/U

UM	MESSAGE ELEMENT	MESSAGE INTENT	RESPONSE
75	WHEN ABLE PROCEED DIRECT TO [position]	Instruction to proceed, when able, directly to the specified position.	W/U
76	AT [time] PROCEED DIRECT TO [position]	Instruction to proceed, at the specified time, directly to the specified position.	W/U
77	AT [position] PROCEED DIRECT TO [position]	Instruction to proceed, at the specified position, directly to the next specified position.	W/U
78	AT [altitude] PROCEED DIRECT TO [position]	Instruction to proceed, upon reaching the specified level, directly to the specified position.	W/U
79	CLEARED TO [position] VIA [route clearance]	Instruction to proceed to the specified position via the specified route.	W/U
80	CLEARED [route clearance]	Instruction to proceed via the specified route.	W/U
81	CLEARED [procedure name]	Instruction to proceed in accordance with the specified procedure.	W/U
82	CLEARED TO DEVIATE UP TO [direction] [distance offset] OF ROUTE	Approval to deviate up to the specified distance from the cleared route in the specified direction.	W/U
83	AT [position] CLEARED [route clearance]	Instruction to proceed from the specified position via the specified route.	W/U
84	AT [position] CLEARED [procedure name]	Instruction to proceed from the specified position via the specified procedure.	W/U
85	EXPECT [route clearance]	Notification that a clearance to fly on the specified route may be issued.	R
86	AT [position] EXPECT [route clearance]	Notification that a clearance to fly on the specified route from the specified position may be issued.	R
87	EXPECT DIRECT TO [position]	Notification that a clearance to fly directly to the specified position may be issued.	R
88	AT [position] EXPECT DIRECT TO [position]	Notification that a clearance to fly directly from the first specified position to the next specified position may be issued.	R
89	AT [time] EXPECT DIRECT TO [position]	Notification that a clearance to fly directly to the specified position commencing at the specified time may be issued.	R
90	AT [altitude] EXPECT DIRECT TO [position] <i>NOT IN USE IN SINGAPORE FIR</i>	Notification that a clearance to fly directly to the specified position commencing when the specified level is reached may be issued.	R

UM	MESSAGE ELEMENT	MESSAGE INTENT	RESPONSE
91	HOLD AT [position] MAINTAIN [altitude] INBOUND TRACK [degrees][direction] TURN LEG TIME [leg type] <i>NOT IN USE IN SINGAPORE FIR</i>	Instruction to enter a holding pattern with the specified characteristics at the specified position and level.	W/U
92	HOLD AT [position] AS PUBLISHED MAINTAIN [altitude] <i>NOT IN USE IN SINGAPORE FIR</i>	Instruction to enter a holding pattern with the published characteristics at the specified position and level.	W/U
93	EXPECT FURTHER CLEARANCE AT [time]	Notification that an onwards clearance may be issued at the specified time.	R
94	TURN [direction] HEADING [degrees] <i>NOT IN USE IN SINGAPORE FIR</i>	Instruction to turn left or right as specified onto the specified heading.	W/U
95	TURN [direction] GROUND TRACK [degrees] <i>NOT IN USE IN SINGAPORE FIR</i>	Instruction to turn left or right as specified onto the specified track.	W/U
96	FLY PRESENT HEADING <i>NOT IN USE IN SINGAPORE FIR</i>	Instruction to continue to fly on the current heading.	W/U
97	AT [position] FLY HEADING [degrees] <i>NOT IN USE IN SINGAPORE FIR</i>	Instruction to fly on the specified heading from the specified position.	W/U
98	IMMEDIATELY TURN [direction] HEADING [degrees] <i>NOT IN USE IN SINGAPORE FIR</i>	Instruction to turn immediately left or right as specified onto the specified heading.	W/U
99	EXPECT [procedure name] <i>NOT IN USE IN SINGAPORE FIR</i>	Notification that a clearance may be issued for the aircraft to fly the specified procedure.	R
178	TRACK DETAIL MESSAGE	<i>Message not defined.</i>	

7 Uplink - Speed Changes

UM	MESSAGE ELEMENT	MESSAGE INTENT	RESPONSE
100	AT [time] EXPECT [speed]	Notification that a speed instruction may be issued to be effective at the specified time.	R
101	AT [position] EXPECT [speed]	Notification that a speed instruction may be issued to be effective at the specified position.	R
102	AT [altitude] EXPECT [speed]	Notification that a speed instruction may be issued to be effective at the specified level.	R
103	AT [time] EXPECT [speed] TO [speed]	Notification that a speed range instruction may be issued to be effective at the specified time.	R
104	AT [position] EXPECT [speed] TO [speed]	Notification that a speed range instruction may be issued to be effective at the specified position.	R
105	AT [altitude] EXPECT [speed] TO [speed]	Notification that a speed range instruction may be issued to be effective at the specified level.	R
106	MAINTAIN [speed]	The specified speed is to be maintained.	W/U
107	MAINTAIN PRESENT SPEED	The present speed is to be maintained.	W/U
108	MAINTAIN [speed] OR GREATER	The specified speed or a greater speed is to be maintained.	W/U
109	MAINTAIN [speed] OR LESS	The specified speed or a lesser speed is to be maintained.	W/U
110	MAINTAIN [speed] TO [speed]	A speed within the specified range is to be maintained.	W/U
111	INCREASE SPEED TO [speed]	The present speed is to be increased to the specified speed and maintained until further advised.	W/U
112	INCREASE SPEED TO [speed] OR GREATER	The present speed is to be increased to the specified speed or greater, and maintained at or above the specified speed until further advised.	W/U
113	REDUCE SPEED TO [speed]	The present speed is to be reduced to the specified speed and maintained until further advised.	W/U
114	REDUCE SPEED TO [speed] OR LESS	The present speed is to be reduced to the specified speed or less and maintained at or below the specified speed until further advised.	W/U
115	DO NOT EXCEED [speed]	The specified speed is not to be exceeded.	W/U
116	RESUME NORMAL SPEED	Notification that the aircraft need no longer comply with the previously issued speed restriction.	W/U

8 Uplink - Contact/Monitor/Surveillance Requests

UM	MESSAGE ELEMENT	MESSAGE INTENT	RESPONSE
117	CONTACT [icaounitname][frequency]	The pilot is required to call the ATS facility on the specified frequency.	W/U
118	AT [position] CONTACT [icaounitname] [frequency]	At the specified position the ATS unit with the specified ATS unit name is to be contacted on the specified frequency.	W/U
119	AT [time] CONTACT [icaounitname] [frequency]	At the specified time the ATS unit with the specified ATS unit name is to be contacted on the specified frequency.	W/U
120	MONITOR [icaounitname][frequency]	The pilot is required to monitor the specified ATS facility on the specified frequency. <i>The Pilot is not required to check in.</i>	W/U
121	AT [position] MONITOR [icaounitname] [frequency]	At the specified position the ATS unit with the specified ATS unit name is to be monitored on the specified frequency.	W/U
122	AT [time] MONITOR [icaounitname] [frequency]	At the specified time the ATS unit with the specified ATS unit name is to be monitored on the specified frequency.	W/U
123	SQUAWK [beacon code]	The specified code (SSR code) is to be selected.	W/U
124	STOP SQUAWK	The SSR transponder responses are to be disabled.	W/U
125	SQUAWK ALTITUDE	The SSR transponder responses should include level information.	W/U
126	STOP ALTITUDE SQUAWK	The SSR transponder responses should no longer include level information.	W/U
179	SQUAWK IDENT	The 'ident' function on the SSR transponder is to be actuated.	W/U

9 Uplink - Report/Confirmation Requests

UM	MESSAGE ELEMENT	MESSAGE INTENT	RESPONSE
127	REPORT BACK ON ROUTE	Instruction to report when the aircraft is back on the cleared route.	R
128	REPORT LEAVING [altitude]	Instruction to report when the aircraft has left the specified level. <i>Either a level that has been maintained, or a level passed through on climb or descent.</i>	R
129	REPORT LEVEL [altitude]	Instruction to report when the aircraft is in level flight at the specified level. <i>Some States do not to use this message in order to avoid confusion because it does not comply with existing voice phraseology</i>	R
175	REPORT REACHING [altitude]	Instruction to report when the aircraft has reached the specified level. <i>To be interpreted as “Report reaching an assigned level.”</i>	R
180	REPORT REACHING BLOCK [altitude] TO [altitude]	Instruction to report when the aircraft is within the specified vertical range.	R
130	REPORT PASSING [position]	Instruction to report when the aircraft has passed the specified position.	R
181	REPORT DISTANCE [to/from] [position]	Instruction to report the present distance to or from the specified position.	NE
131	REPORT REMAINING FUEL AND SOULS ON BOARD	Instruction to report the amount of fuel remaining and the number of persons on board.	NE
132	CONFIRM POSITION	Instruction to report the present position.	NE
133	CONFIRM ALTITUDE	Instruction to report the present level.	NE
134	CONFIRM SPEED	Instruction to report the present speed.	NE
135	CONFIRM ASSIGNED ALTITUDE	Instruction to confirm and acknowledge the currently assigned level.	NE
136	CONFIRM ASSIGNED SPEED	Instruction to confirm and acknowledge the currently assigned speed.	NE
137	CONFIRM ASSIGNED ROUTE	Instruction to confirm and acknowledge the currently assigned route.	NE
138	CONFIRM TIME OVER REPORTED WAYPOINT	Instruction to confirm the previously reported time over the last reported waypoint.	NE

UM	MESSAGE ELEMENT	MESSAGE INTENT	RESPONSE
139	CONFIRM REPORTED WAYPOINT	Instruction to confirm the identity of the previously reported waypoint.	NE
140	CONFIRM NEXT WAYPOINT	Instruction to confirm the identity of the next waypoint.	NE
141	CONFIRM NEXT WAYPOINT ETA	Instruction to confirm the previously reported estimated time at the next waypoint.	NE
142	CONFIRM ENSUING WAYPOINT	Instruction to confirm the identity of the next plus one waypoint.	NE
143	CONFIRM REQUEST	The request was not understood. It should be clarified and resubmitted.	NE
144	CONFIRM SQUAWK	Instruction to report the currently selected transponder code.	NE
145	CONFIRM HEADING	Instruction to report the present heading.	NE
146	CONFIRM GROUND TRACK	Instruction to report the present ground track.	NE
182	CONFIRM ATIS CODE	Instruction to report the identification code of the last ATIS received.	NE
147	REQUEST POSITION REPORT	Instruction to make a position report. <i>To be used if the controller does not receive a scheduled position report.</i>	NE

10 Uplink - Negotiation Requests

148	WHEN CAN YOU ACCEPT [altitude]	Request for the earliest time at which the specified level can be accepted.	NE
149	CAN YOU ACCEPT [altitude] AT [position]	Instruction to report whether or not the specified level can be accepted at the specified position.	A/N
150	CAN YOU ACCEPT [altitude] AT [time]	Instruction to report whether or not the specified level can be accepted at the specified time.	A/N
151	WHEN CAN YOU ACCEPT [speed]	Instruction to report the earliest time when the specified speed can be accepted.	NE
152	WHEN CAN YOU ACCEPT [distance offset] [direction] OFFSET	Instruction to report the earliest time when the specified offset track can be accepted.	NE

11 Uplink - Air Traffic Advisories

UM	MESSAGE ELEMENT	MESSAGE INTENT	RESPONSE
153	ALTIMETER [altimeter]	ATS advisory that the altimeter setting should be the specified setting.	R
154	RADAR SERVICES TERMINATED	ATS advisory that the radar service is terminated.	R
155	RADAR CONTACT [position]	ATS advisory that radar contact has been established at the specified position.	R
156	RADAR CONTACT LOST	ATS advisory that radar contact has been lost.	R
157	CHECK STUCK MICROPHONE [frequency]	A continuous transmission is detected on the specified frequency. Check the microphone button.	R
158	ATIS [atis code]	ATS advisory that the ATIS information identified by the specified code is the current ATIS information.	R

12 Uplink - System Management Messages

159	ERROR [error information]	A system generated message that the ground system has detected an error.	NE
160	NEXT DATA AUTHORITY [facility designation]	Notification to the avionics that the next data authority is the specified ATSU.	NE
161	END SERVICE	Notification to the avionics that the data link connection with the current data authority is being terminated.	NE
162	SERVICE UNAVAILABLE	Notification that the ground system does not support this message.	NE
163	[icao facility designation] [tp4Table]	Notification to the pilot of an ATSU identifier.	NE

13 Uplink - Additional Messages

UM	MESSAGE ELEMENT	MESSAGE INTENT	RESPONSE
164	WHEN READY	The associated instruction may be complied with at any future time.	NE
165	THEN	Used to link two messages, indicating the proper order of execution of clearances/ instructions.	NE
166	DUE TO TRAFFIC	The associated instruction is issued due to traffic considerations.	NE
167	DUE TO AIRSPACE RESTRICTION	The associated instruction is issued due to airspace restrictions.	NE
168	DISREGARD	The indicated communication should be ignored. <i>The previously sent uplink CPDLC message shall be ignored. DISREGARD should not refer to a clearance or instruction. If DISREGARD is used, another element shall be added to clarify which message is to be disregarded.</i>	R
176	MAINTAIN OWN SEPARATION AND VMC	Notification that the pilot is responsible for maintaining separation from other traffic and is also responsible for maintaining Visual Meteorological Conditions.	W/U
177	AT PILOTS DISCRETION	Used in conjunction with a clearance or instruction to indicate that the pilot may execute when prepared to do so.	N
169	[free text]	<i>Normal urgency attribute</i>	R
170	[free text]	<i>Distress urgency attribute</i>	R

14 Downlink - Responses

DM	MESSAGE ELEMENT	MESSAGE INTENT	RESPONSE
0	WILCO	The instruction is understood and will be complied with.	N
1	UNABLE	The instruction cannot be complied with.	N
2	STANDBY	Wait for a reply. <i>The controller is informed that the request is being assessed and there will be a <u>short term</u> delay (within 10 minutes). The exchange is not closed and the request will be responded to when conditions allow.</i>	N
3	ROGER	Message received and understood. <i>ROGER is the only correct response to an uplink free text message. Under no circumstances will AFFIRM be used instead of ROGER.</i>	N
4	AFFIRM	Yes <i>AFFIRM is an appropriate response to an uplinked negotiation request message (e.g. CAN YOU ACCEPT [altitude] AT [time]).</i>	N
5	NEGATIVE	No <i>NEGATIVE is an appropriate response to an uplinked negotiation request message (e.g. CAN YOU ACCEPT [altitude] AT [time]).</i>	N

15 Downlink - Vertical Requests

6	REQUEST [altitude]	Request to fly at the specified level.	Y
7	REQUEST BLOCK [altitude] TO [altitude]	Request to fly at a level within the specified vertical range.	Y
8	REQUEST CRUISE CLIMB TO [altitude]	Request to cruise climb to the specified level. <i>Due to different interpretations between the various ATS units, this element should be avoided.</i>	Y
9	REQUEST CLIMB TO [altitude]	Request to climb to the specified level.	Y

DM	MESSAGE ELEMENT	MESSAGE INTENT	RESPONSE
10	REQUEST DESCENT TO [altitude]	Request to descend to the specified level.	Y
11	AT [position] REQUEST CLIMB TO [altitude]	Request that at the specified position a climb to the specified level be approved.	Y
12	AT [position] REQUEST DESCENT TO [altitude]	Request that at the specified position a descent to the specified level be approved.	Y
13	AT [time] REQUEST CLIMB TO [altitude]	Request that at the specified time a climb to the specified level be approved.	Y
14	AT [time] REQUEST DESCENT TO [altitude]	Request that at the specified time a descent to the specified level be approved.	Y

16 Downlink - Lateral Off-Set Requests

15	REQUEST OFFSET [distance offset] [direction] OF ROUTE	Request that a parallel track, offset from the cleared track by the specified distance in the specified direction, be approved.	Y
16	AT [position] REQUEST OFFSET [distance offset] [direction] OF ROUTE	Request that a parallel track, offset from the cleared track by the specified distance in the specified direction, be approved from the specified position.	Y
17	AT [time] REQUEST OFFSET [distance offset] [direction] OF ROUTE	Request that a parallel track, offset from the cleared track by the specified distance in the specified direction, be approved from the specified time.	Y

17 Downlink - Speed Requests

18	REQUEST [speed]	Request to fly at the specified speed.	Y
19	REQUEST [speed] TO [speed]	Request to fly within the specified speed range.	Y

18 Downlink - Voice Contact Requests

DM	MESSAGE ELEMENT	MESSAGE INTENT	RESPONSE
20	REQUEST VOICE CONTACT	Request for voice contact.	Y
21	REQUEST VOICE CONTACT [frequency]	Request for voice contact on the specified frequency.	Y

19 Downlink - Route Modification Requests

22	REQUEST DIRECT TO [position]	Request to track from the present position direct to the specified position.	Y
23	REQUEST [procedure name]	Request for the specified procedure clearance.	Y
24	REQUEST [route clearance]	Request for a route clearance.	Y
25	REQUEST CLEARANCE	Request for either a pre-departure or route clearance.	Y
26	REQUEST WEATHER DEVIATION TO [position] VIA [route clearance]	Request for a weather deviation to the specified position via the specified route.	Y
27	REQUEST WEATHER DEVIATION UP TO [distance offset] [direction] OF ROUTE	Request for a weather deviation up to the specified distance off track in the specified direction.	Y
70	REQUEST HEADING [degrees]	Request a clearance to adopt the specified heading.	Y
71	REQUEST GROUND TRACK [degrees]	Request a clearance to adopt the specified ground track.	Y

20 Downlink - Reports

DM	MESSAGE ELEMENT	MESSAGE INTENT	RESPONSE
28	LEAVING [altitude]	Notification of leaving the specified level.	N
29	CLIMBING TO [altitude]	Notification of climbing to the specified level.	N
30	DESCENDING TO [altitude]	Notification of descending to the specified level.	N
31	PASSING [position]	Notification of passing the specified position.	N
78	AT [time] [distance] [to/from] [position]	At the specified time, the aircraft's position was as specified.	N
32	PRESENT ALTITUDE [altitude]	Notification of the present level.	N
33	PRESENT POSITION [position]	Notification of the present position.	N
34	PRESENT SPEED [speed]	Notification of the present speed.	N
35	PRESENT HEADING [degrees]	Notification of the present heading in degrees.	N
36	PRESENT GROUND TRACK [degrees]	Notification of the present ground track in degrees.	N
37	LEVEL [altitude]	Notification that the aircraft is maintaining the specified level.	N
72	REACHING [altitude]	Notification that the aircraft has reached the specified level.	N
76	REACHING BLOCK [altitude] TO [altitude]	Notification that the aircraft has reached a level within the specified vertical range.	N
38	ASSIGNED ALTITUDE [altitude]	Read-back of the assigned level.	N
77	ASSIGNED BLOCK [altitude] TO [altitude]	Read-back of the assigned vertical range.	N
39	ASSIGNED SPEED [speed]	Read-back of the assigned speed.	N
40	ASSIGNED ROUTE [route clearance]	Read-back of the assigned route.	N
41	BACK ON ROUTE	The aircraft has regained the cleared route.	N
42	NEXT WAYPOINT [position]	The next waypoint is the specified position.	N

DM	MESSAGE ELEMENT	MESSAGE INTENT	RESPONSE
43	NEXT WAYPOINT ETA [time]	The ETA at the next waypoint is as specified.	N
44	ENSUING WAYPOINT [position]	The next plus one waypoint is the specified position.	N
45	REPORTED WAYPOINT [position]	Clarification of previously reported waypoint passage.	N
46	REPORTED WAYPOINT [time]	Clarification of time over previously reported waypoint.	N
47	SQUAWKING [beacon code]	The specified (SSR) code has been selected.	N
48	POSITION REPORT [position report]	Reports the current position of the aircraft when the pilot presses the button to send this message. <i>ATC expects position reports based on this downlink message</i>	N
79	ATIS [atis code]	The code of the latest ATIS received is as specified.	N
80	DEVIATING [distance offset] [direction] OF ROUTE	Notification that the aircraft is deviating from the cleared route by the specified distance in the specified direction.	N

21 Downlink - Negotiation Requests

49	WHEN CAN WE EXPECT [speed]	Request for the earliest time at which a clearance to the specified speed can be expected.	Y
50	WHEN CAN WE EXPECT [speed] TO [speed]	Request for the earliest time at which a clearance to a speed within the specified range can be expected.	Y
51	WHEN CAN WE EXPECT BACK ON ROUTE	Request for the earliest time at which a clearance to regain the planned route can be expected.	Y
52	WHEN CAN WE EXPECT LOWER ALTITUDE	Request for the earliest time at which a clearance to descend can be expected.	Y
53	WHEN CAN WE EXPECT HIGHER ALTITUDE	Request for the earliest time at which a clearance to climb can be expected.	Y
54	WHEN CAN WE EXPECT CRUISE CLIMB TO [altitude]	Request for the earliest time at which a clearance to cruise climb to the specified level can be expected.	Y

22 Downlink - Emergency Messages

DM	MESSAGE ELEMENT	MESSAGE INTENT	RESPONSE
55	PAN PAN PAN	Urgency prefix.	N
56	MAYDAY MAYDAY MAYDAY	Distress prefix.	N
57	[remaining fuel] OF FUEL REMAINING AND [souls on board] SOULS ON BOARD	Notification of fuel remaining and number of persons on board.	N
58	CANCEL EMERGENCY	Notification that the pilot wishes to cancel the emergency condition.	N
59	DIVERTING TO [position] or DIVERTING TO [position] VIA [x]	Notification that the aircraft is diverting to the specified position via the specified route.	N
60	OFFSETTING [distance offset] [direction] OF ROUTE	Notification that the aircraft is deviating the specified distance in the specified direction off the cleared route and maintaining a parallel track.	N
61	DESCENDING TO [altitude]	Notification that the aircraft is descending to the specified level.	N

23 Downlink -System Management Messages

62	ERROR [error information]	A system generated message that the avionics has detected an error.	N
63	NOT CURRENT DATA AUTHORITY	A system generated denial to any CPDLC message sent from a ground facility that is not the Current Data Authority.	N
64	[icao facility designation]	Notification to the ground system that the specified ATSU is the current data authority.	N
73	[version number]	A system generated message indicating the software version number.	N

24 Downlink -Additional Messages

DM	MESSAGE ELEMENT	MESSAGE INTENT	RESPONSE
65	DUE TO WEATHER	Used to explain reasons for aircraft operator's message.	N
66	DUE TO AIRCRAFT PERFORMANCE	Used to explain reasons for aircraft operator's message.	N
74	MAINTAIN OWN SEPARATION AND VMC	States a desire by the pilot to provide his/her own separation and remain in VMC.	N
75	AT PILOTS DISCRETION	Used in conjunction with another message to indicate that the pilot wishes to execute the request when the pilot is prepared to do so.	N
67	[free text]	<i>Normal urgency attribute</i>	N
67b	WE CAN ACCEPT [altitude] AT [time]	We can accept the specified level at the specified time.	N
67c	WE CAN ACCEPT [speed] AT [time]	We can accept the specified speed at the specified time.	N
67d	WE CAN ACCEPT [distance offset] [direction] AT [time]	We can accept a parallel track offset the specified distance in the specified direction at the specified time.	N
67e	WE CANNOT ACCEPT [altitude]	We cannot accept the specified level.	N
67f	WE CANNOT ACCEPT [speed]	We cannot accept the specified speed.	N
67g	WE CANNOT ACCEPT [distance offset] [direction]	We cannot accept a parallel track offset the specified distance in the specified direction.	N
67h	WHEN CAN WE EXPECT CLIMB TO [altitude]	Request for the earliest time at which a clearance to climb to the specified level can be expected.	N
67i	WHEN CAN WE EXPECT DESCENT TO [altitude]	Request for the earliest time at which a clearance to descend to the specified level can be expected.	N
67L	TO DELAY FOR AIR REFUEL AT [position] UNTIL [time]; and	The tanker is requesting a clearance to delay at the ARCP until the rendezvous with the receiver. [position] is the ARCP as filed in the tanker's flight plan. [time] is the time the tanker expects to pass the ARCP and commence refueling along the refueling track. It is also the end of the delay time.	

DM	MESSAGE ELEMENT	MESSAGE INTENT	RESPONSE
67n	DL# 67 EXPECT END OF REFUEL AT [xxxxx]	The tanker pilot is providing notification that the end of refueling is imminent. [xxxxx] may be either position or time.	
67o	DL# 67 JOINING ALTRV [xxxxxx] AT [xxxxxx]	[XXXXXX] can be either a point or a time Example: JOINING ALTRV CW413 AT HEMLO or JOINING ALTRV CW413 AT 1530Z	
67p	ACCEPT MARSA WITH [callsign(s) of other aircraft]	The tanker is accepting MARSA procedures with the receiver <i>Note: [receiver callsign] is the flight planned callsign of the receiver</i>	
68	[free text]	<i>Distress urgency attribute</i>	Y

APPENDIX 5B

FANS-1/A CPDLC Standard Free Text Messages

This Section contains a complete listing of the standard free text messages and intent for FANS-1/A CPDLC.

When a free text uplink message has been received, the pilot shall respond with the QUICK RESPONSE from the table before responding to the message.

1. Uplink - Free Text Report/ Confirmation Requests

	FREE TEXT MESSAGE	QUICK RESPONSE
Controller	REPORT SIGHTING AND PASSING OPPOSITE DIRECTION [traffic description] ETP [time] <i>The traffic description is to be inserted by the controller and shall include the aircraft identification (callsign), flight level and aircraft type. ETP = Estimated Time of Passing.</i> <i>Example of the traffic description: SIA228 B747 FL370</i>	
Pilot Response	[traffic identification] SIGHTED AND PASSED <i>Example - SIA228 SIGHTED AND PASSED</i> or [traffic identification] NOT SIGHTED	ROGER
Message Intent	The controller is requesting that the pilot notify when the specified traffic has been seen by visual contact and passed. The level specified in the traffic description is the level being maintained by the opposite direction aircraft.	

	FREE TEXT MESSAGE	QUICK RESPONSE
Controller	REPORT GROUND SPEED	
Pilot Response	GS [speed] <i>Example - GS 490</i>	ROGER
Message Intent	The controller is requesting the pilot to report the present ground speed.	

	FREE TEXT MESSAGE	QUICK RESPONSE
Controller	STATE PREFERRED LEVEL (Ref: ICAO UM231)	
Pilot Response	FL [altitude] <i>Example - FL 350</i>	ROGER
Message Intent	The controller is requesting that the pilot advise the preferred flight level for the flight.	

Controller	REPORT ETA [position] <i>Example – REPORT ETA BILBO</i> (Ref: ICAO UM228)	
Pilot Response	[position] [time] <i>Example - BILBO 0413</i>	ROGER
Message Intent	The controller is requesting an estimate for the specified waypoint.	

Controller	WHEN WILL YOU MAINTAIN FL [altitude]	
Pilot Response	FL [altitude] AT [time] <i>Example - FL 350 AT 2317</i>	ROGER
Message Intent	The controller is requesting from the pilot the time at which the aircraft will maintain the specified level.	

	FREE TEXT MESSAGE	QUICK RESPONSE
Controller	AT WHAT DISTANCE [position / waypoint] WILL YOU MAINTAIN FL [altitude]	
Pilot Response	FL [altitude] AT [distance] NM [direction] [position / waypoint] <i>Example - FL 350 AT 26 NM W IPEMA</i>	ROGER
Message Intent	The controller is requesting the distance from the specified position or waypoint at which the aircraft will maintain the specified level. The pilot shall include the direction from the waypoint as a cardinal point, e.g. N, NE, NW, S, SW, SE, E or W.	

Controller	REPORT RADIAL AND DISTANCE [to/from] [position]	
Pilot Response	[radial] R [distance] NM [to/from] [position] <i>Example - 320 R 26 NM FROM MCY</i>	ROGER
Message Intent	The controller is requesting that the pilot report the radial on which the aircraft is proceeding and the distance from the specified VOR.	

Controller	REQUEST VOICE CONTACT [frequency]	
Pilot Response		ROGER
Message Intent	The controller is requesting that the pilot makes voice contact / radio check call on the specified frequency.	

2 Uplink - Free Text Instructions

	FREE TEXT MESSAGE	QUICK RESPONSE
Controller	CHECK AND RESPOND TO OPEN CPDLC MESSAGES	
Pilot Response		ROGER
Message Intent	The controller has detected that uplink messages exist that the pilot has not yet responded to. The pilot is required to check the ATC log page and to respond to unanswered uplink messages.	

Controller	TRANSMIT ADS-B IDENT	
Pilot Response		ROGER
Message Intent	Instruction that the “ident” function of the ADS-B emitter is to be activated	

3 Uplink - Free text Advisories

Controller	EXPECT SELCAL CHECK HF [frequency]	
Pilot Response		ROGER
Message Intent	The controller is notifying the pilot that a selcal check will be made on the specified HF frequency.	

Controller	EXPECT CPDLC TRANSFER AT [time]	
Pilot Response		ROGER
Message Intent	The controller is notifying the pilot that the CPDLC transfer process will not be completed at the FIR boundary and will be delayed until the specified time. If the CPDLC transfer is not completed by the specified time, the pilot shall manually disconnect and logon to the next centre.	

	FREE TEXT MESSAGE	QUICK RESPONSE
Controller	IDENTIFICATION TERMINATED	
Pilot Response		ROGER
Message Intent	ATS advisory that the radar and/or ADS-B service is terminated	

Controller	EXPECT NEXT CENTER [ATSU name]. CONTACT WITH [ATSU name] NOT REQUIRED	
Pilot Response		ROGER
Message Intent	The controller is notifying the pilot that CPDLC connection is not required by the next FIR (where the flight's transition time of that FIR is short) and CPDLC connection will be transferred to the subsequent FIR.	

The [ATSU name] is the relevant four character ICAO code.

Controller	TRAFFIC IS [traffic description]	
Pilot Response	(optional) TRAFFIC SIGHTED	ROGER
Message Intent	The controller is notifying the pilot of traffic significant to the flight. The description will include the aircraft type and any other relevant information to assist the pilot in sighting the traffic. The pilot may respond that the traffic has been sighted.	

Controller	SECONDARY FREQUENCY [frequency]	
Pilot Response		ROGER
Message Intent	Notification that the secondary frequency is as specified.	

4 Uplink - Free Text Speed Messages

	FREE TEXT MESSAGE	QUICK RESPONSE
Controller	EXPECT TO MAINTAIN [speed] UNTIL [time / position]	
Pilot Response		ROGER
Message Intent	The controller is notifying the pilot that a speed instruction may be issued to be effective until the specified time.	

5 Uplink - Free Text Emergency Acknowledgment

Controller	ROGER MAYDAY	
Pilot Response		ROGER
Message Intent	The controller has acknowledged receipt of a MAYDAY downlink message. The controller shall attempt to make voice contact with the pilot. The pilot should only respond with ROGER if or when able to do so. If the aircraft is inbound to an airport within the FIR, a ROGER response is not required.	

Controller	ROGER PAN	
Pilot Response		ROGER
Message Intent	The controller has acknowledged receipt of a PAN downlink message. The controller shall attempt to make voice contact with the pilot. The pilot should only respond with ROGER if or when able to do so. If the aircraft is inbound to an airport within the FIR, a ROGER response is not required.	

6 Downlink - Free Text Advisories

	FREE TEXT MESSAGE	QUICK RESPONSE
Pilot	WAKE DEV [direction] <i>Direction L or R (left or right) as appropriate</i>	
Controller Response		ROGER
Message Intent	The pilot is offsetting due wake turbulence in accordance with RVSM procedures (offset will not exceed 2nm). The controller is not required to respond or issue a clearance.	

Pilot	REVISED ETA [position] [time]	
Controller Response		ROGER
Message Intent	The pilot is advising ATC of an update a waypoint ETA.	

APPENDIX 6

ATS INTERFACILITY DATA COMMUNICATIONS (AIDC) MESSAGES

Note: This appendix is reserved.

INTENTIONALLY LEFT BLANK

APPENDIX 7

APPLICATION FORM FOR AIR TRAFFIC SERVICE PROVIDER (ATSP) CERTIFICATE

Note: This appendix is reserved.

INTENTIONALLY LEFT BLANK

APPENDIX 8

FACILITY REQUIREMENTS

1 INTRODUCTION

1.1 An applicant for the grant of an air traffic service certificate must establish the following facilities that are appropriate to the air traffic services listed in the applicant's exposition:

- (a) aerodrome control towers
- (b) approach control offices
- (c) area control centres
- (d) flight information centres
- (e) dedicated training and assessment facilities.

2 AERODROME CONTROL SERVICE

2.1 An applicant for an aerodrome control service must establish procedures to ensure that any aerodrome control tower listed in the applicant's exposition, is provided with equipment for two-way voice communication with:

- (a) any aircraft, in or adjacent to airspace for which the applicant has responsibility; and
- (b) any aircraft, vehicle, and person, on, or adjacent to, the manoeuvring area.

2.2 The aerodrome control tower should be provided with the following minimum equipment:

- (a) a display system or systems designed to show the disposition of current and pending aerodrome traffic together with ancillary information for individual aircraft;
- (b) a power supply;
- (c) appropriate and current maps and charts;

- (d) binoculars;
- (e) clocks;
- (f) log keeping system;
- (g) outside temperature indicator;
- (h) QNH display;
- (i) RVR display
- (j) signal lamp with green, red, and white functions;
- (k) telephone communications;
- (l) status monitors for approach and landing aids and any signalling equipment affecting the use of a runway;
- (m) visibility checkpoints;
- (n) voice and, if applicable, data recording equipment;
- (o) wind direction and wind speed display;
- (p) an audible emergency alerting system;
- (q) means of reception and transmission of information normally conveyed by AFTN;
- (r) airfield lighting controls panel; and
- (s) 2 independent sources of the current altimeter setting, at least 1 of which must be an aneroid barometer or barometric altimeter situated in the visual control room.

3 AREA CONTROL CENTRE / APPROACH CONTROL UNIT

3.1 The applicant must establish procedures to ensure that an area control centre, a flight information centre, and an approach control unit is provided with equipment enabling to the fullest extent practical, two-way voice communication; and if applicable, data communication with any aircraft in, or adjacent to, airspace for which the applicant has responsibility.

3.2 The area control centre and/or the approach control unit should be provided with the following minimum equipment:

- (a) a display system or systems designed to show the disposition of current and pending flights together with ancillary information for individual aircraft;
- (b) a power supply;
- (c) appropriate and current maps and charts;
- (d) clocks;
- (e) log keeping system;
- (f) status monitors as appropriate for navigation, approach, and landing aids;
- (g) telephone communications;
- (h) voice recording equipment and, if applicable, data recording equipment;
- (i) an AFTN terminal;
- (j) for an approach control operating position, an ILS/MLS status monitor at the approach control or approach control radar operating position for the aerodrome concerned;
- (k) for an approach control operating position responsible for aircraft on final approach, or aircraft landing or taking off, a wind direction and wind speed display, and RVR fed from the same source as the corresponding equipment in the aerodrome control tower.

3.3 The applicant must establish procedures to ensure that the aeronautical telecommunications equipment required are operated in accordance with the requirements of Annex 10 and the Manual of Standards for Aeronautical Telecommunication.

3.4 The applicant must establish procedures to ensure that any visual display unit used by an air traffic service is positioned with due regard to the relative importance of the information displayed and ease of use by the staff concerned.

3.5 The equipment required must have a level of reliability, availability, and redundancy, that minimises the possibility of failure, non-availability, or significant degradation of performance.

3.6 The applicant must establish procedures to ensure that the status monitors required are fitted with:

- (a) an aural signal to indicate a change of status; and
- (b) a visual indication of the current status.

3.7 A temporary aerodrome control tower is not required to be provided with the equipment required under paragraphs 2.2 (k) and (q) if it is impracticable to do so and other appropriate measures are taken, as the case may be, to:

- (a) provide the person providing the air traffic service from the temporary tower with the information that would be available from the equipment required under paragraphs 2.2 (k) and (q); and
- (b) control the airfield lighting if applicable.

APPENDIX 9

DOCUMENTS AND RECORDS

1 General

1.1 Documents

1.1.1 A document control system covers the authorisation, standardisation, publication, distribution and amendment of all documentation issued by the organisation, or required by the organisation for the provision of air traffic services.

1.1.2 These processes must ensure:

- (a) authorisation is by a designated authority appropriate to the management and safety accountability structures;
- (b) currency can be readily determined;
- (c) availability at locations where needed by ATS personnel;
- (d) only current versions are available;
- (e) a master copy is securely held;
- (f) archival where superseded.

1.2 Records

1.2.1 A system for records covers identification, collection, indexing, storage, security, maintenance, access and disposal of records necessary for the provision of air traffic services.

1.2.2 Records systems must provide an accurate chronicle of ATS activities for the purpose of reconstruction of events for air safety investigation, and for system safety analysis.

1.3 Records to be Kept

1.3.1 Automatic recordings. The following items used for the provision of air traffic services must be recorded automatically and retained for the period shown:

- (a) direct pilot-controller two-way radiotelephony or datalink communications—30 days;
- (b) direct-speech or data link between air traffic services units—30 days;
- (c) surveillance data from primary and secondary radar equipment or obtained through ADS—30 days;
- (d) automated flight data processing including on-screen display of aircraft tracks and label blocks—30 days (consistency with sub-paragraph (c) above).

Note: Where possible, provision of synchronous integration of radar and on-screen data with related voice recordings should be facilitated.

1.3.2 **Time injection.** Automatic recordings must have a means of establishing accurately the time, in hours/minutes/seconds, at which any recorded event occurred.

1.3.3 **Document records.** The following items must be kept for a minimum of 30 days (ICAO Air Traffic Services Planning Manual):

- (a) ATS messages, including flight plans;
- (b) flight progress strips or documents of a similar nature used for the recording of flight data and the issue of clearances, instructions and directions;
- (c) transcripts of automated weather broadcasts (e.g. ATIS);
- (d) log books;

1.3.4 **Additional items.** Records of the following additional items must be kept for a minimum of 5 years:

- (a) details of interruptions to services;
- (b) details of failures of equipment used for the provision of air traffic services;
- (c) details of facility unavailability;
- (d) staff duty rosters;

(e) details of actions carried out under the Safety Management System including follow-up corrective and preventative actions;

(f) directions and instructions issued to staff for the provision of air traffic services.

1.3.5 Personnel Licensing Records. Records of ATS personnel licensing and competency certification must be kept for a minimum of 5 years, including after an employee ceases to be employed by the ATS provider. This includes details of:

(a) training;

(b) renewal and currency of ratings, endorsements and qualifications; and

(c) other proficiencies required by the ATS provider to be demonstrated.

1.3.6 Record retention for investigation. Where requisitioned, by an appropriate authority, for the purposes of investigation, records must be isolated and kept in a secure place until their release by that authority.

1.4 Maintaining Records

1.4.1 Deletions from communications records are not permitted. All entries must be written in non-erasable ink, and must be legible.

1.4.2 Active forms or strips, fault reports, records and Log Books must be changed, or errors corrected by:

(a) drawing a line through the incorrect data and writing the correct data adjacent thereto; or

(b) cancelling the old and rewriting the record, retaining both the old and the new for later reference purposes.

1.4.3 Methods of recording. Information transmitted or received by verbal means must be recorded by electronic means. Voice records must be supported by one or more of the following methods:

(a) writing on a flight progress strip;

(b) typewritten on authorised forms;

(c) teletyped on page copy machine units;

(d) handwritten in accordance with local requirements;

- (e) handwritten on appropriate forms;
- (f) entered directly into computer-based equipment.

1.4.4 **Flight notifications.** A copy of all flight notifications received must be held for 90 days. Printed flight notifications shall be filed with the day's traffic. Electronic records shall be archived via a suitable "off-line" media such as tape, disk array or optical disk.

1.5 Maintaining Operational Log Books

1.5.1 The Log Book must be used to record all significant occurrences and actions relating to operations, facilities, equipment and staff at an ATS unit.

1.5.2 A working record or Log Book entry must not be inserted between earlier entries. In the event of an out of sequence entry being necessary, it must be entered as soon as possible, and annotated that it is out of sequence.

1.5.3 All Log Book entries must be recorded against the times of the occurrence, or time of the Log Book entry.

1.5.4 **Minimum information to be recorded.** The minimum information to be recorded is shown in the following table.

Occasion	Information
At the commencement of each day's operation	<ul style="list-style-type: none"> ▪ UTC date and time; ▪ Where required, identification of the unit and/or the operating position.
On assuming responsibility for a position	<ul style="list-style-type: none"> ▪ The UTC date and time of assuming responsibility for a position and the signature of the officer commencing duty (see also voice recordings); ▪ Results of equipment checks;
During operation of the unit	<ul style="list-style-type: none"> ▪ ATC incidents, including accidents and breaches of the regulations such as noncompliance with ATC instructions; ▪ Actions taken in relation to any SAR activity including distress communications; ▪ General notes concerning essential aerodrome information, such as the results of aerodrome inspections, closure of sections of the manoeuvring area caused by works or natural phenomena, etc.; ▪ Times of aerodrome closure and reopening, with reasons for the closure; • Change in status of facilities, service or procedure including communication difficulties and tests; ▪ Short term changes in staffing or hours of coverage, including variations to required staffing levels; ▪ Status of navigation aids.
Handover/takeover (where a separate form is not provided and kept as a record)	<ul style="list-style-type: none"> ▪ A resume of outstanding action and unusual operations which are current or anticipated, relating to the traffic display and/or SAR activity; ▪ The status of communications and equipment; ▪ The time of handover/takeover, against the signatures of the officers involved.
Closure of unit and/or position	<ul style="list-style-type: none"> ▪ Time of closure and conditions and actions relating to the closure, followed by changes to equipment status, and any outstanding action; ▪ The time of intended reopening, and the signature of the officer closing the unit/position.

1.6 Voice and Data Recording

1.6.1 Where appropriate voice recording facilities are available, details of opening and closing watch, or the identification of staff assuming responsibility for a position may be recorded orally in lieu of a logbook entry. In either case, the procedures used must be sufficient to readily establish, for the purposes of investigation, the status of the position (active/inactive) and the person responsible for any active position, at any given time.

1.6.2 When an automatic voice recording facility fails, a manual record of communications must be maintained, to the extent that this is possible.

APPENDIX 10

Safety Management System Framework

The framework for the implementation and maintenance of a safety management system should include, as a minimum, the following 4 components and 12 elements:

1. Safety Policy and Objectives
 - (a) Management commitment and responsibility
 - (b) Safety accountabilities
 - (c) Appointment of key safety personnel
 - (d) Coordination of emergency response planning
 - (e) SMS documentation
2. Safety Risk Management
 - (a) Hazard identification
 - (b) Safety risk assessment and mitigation processes
3. Safety Assurance
 - (a) Safety performance monitoring and measurement
 - (b) Management of change
 - (c) Continuous improvement of the SMS
4. Safety Promotion
 - (a) Training and education
 - (b) Safety communication

Note: Refer to AC 1-3 for CAAS SMS guidance materials. Reference may also be made to ICAO SMM Document 9859 for any additional guidance where appropriate.